



UMPQUA[®]



PRODUCT CATALOG 2024



CONTENTS

Note from the President.....	2
Terms and Conditions.....	4
Umpqua Signature Fly Designers.....	6
New 2024 Products.....	16
Freshwater Flies.....	50
Bass, Subsurface 54	
Bass, Topwater 56	
Carp 58	
Peacock Bass and Jungle 60	
Pike/Muskie 62	
Dry Flies 64	
Dry Flies, Drakes 70	
Dry Flies, Spinners 80	
Terrestrials 84	
Midges and Emergers 94	
Nymphs and Wet Flies 102	
Hare's Ears 110	
Pheasant Tails 116	
Princes 118	
Soft Hackles 121	
Jigged/ Euro Flies 128	
Eggs,Worms,Scuds & Shrimp 136	
Lake Flies 144	
Streamers 152	
Steelhead Pacific-Alaska,PNW 162	
Saltwater Flies.....	170
Saltwater Flats 172	
Bluefish/Stripers 180	
Tarpon 186	
Saltwater Poppers/Sliders 190	
All Purpose Saltwater 192	
Fly Selections	198
Leader and Tippet	208
UMPQUA Packs & Bags	236
Streamside Accessories	256
Floatants, Indicators, Gadgets, Tools, and Other Boxes	
Apparel and Merchandise.....	276
Tiemco®, U-Series & Competition Series, X-Series Hooks.....	304
Tools, Kits and Metz® Tying Materials.....	346
Metz® Saddles and Necks.....	360
Signature Fly Index by Designer	382
General Fly Index	390



UMPQUA FEATHER MERCHANTS
 594 S Arthur Ave.
 Louisville, CO 80027
 PH: 303.567.6696
 FX: 303.865.3931

COVER PHOTO BY JAKOB BURLESON

LETTER FROM THE PRESIDENT

Greetings! The Umpqua team works tirelessly in hopes of fulfilling our vision “To Give People Their Best Day on the Water”. So much of what the team does is behind the scenes and not highly visible outside our walls; that’s why the introduction of a new catalog is such an exciting time of the year. Within these pages, you will find one of the visible results of the team’s day in and day out efforts. We are thrilled to share with you our 2024 catalog.

You will notice a strong offering of new products for this coming year. We have a fabulous new fly offering that will undoubtedly reflect at your cash register. And if you know any flats anglers, you’ve probably already heard about our recently introduced Deceiver **Pink** Fluorocarbon. Streamside accessories continue to be a staple for every successful fly-fishing retailer and as a result, we have completely revamped our UPG fly box offering. This is an all-inclusive premium box line, with the entire offering available in both silicone and foam. We also took a close look at streamside tools, and have no doubt our new River Grip Precision Series will spice up your streamside wall as well as your bottom-line. We are confident that our new additions this year will help to continue to drive revenue in your business.

As we look ahead, we are excited about the coming year, for both Umpqua and our industry. Most of the challenges brought on by COVID are in the rearview mirror and although our nation may face some economic speedbumps, our industry is healthy and vibrant.

Thank you for your continued support of Umpqua. We realize that no matter how many new flies or how many cool new products we introduce, none of it would matter without your support. Thank You for your business and Thank You for choosing Umpqua!

Best Regards,

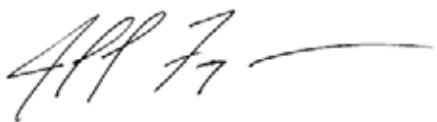
A handwritten signature in black ink, appearing to read "Jeff Fryhover", with a long horizontal flourish extending to the right.

Jeff Fryhover

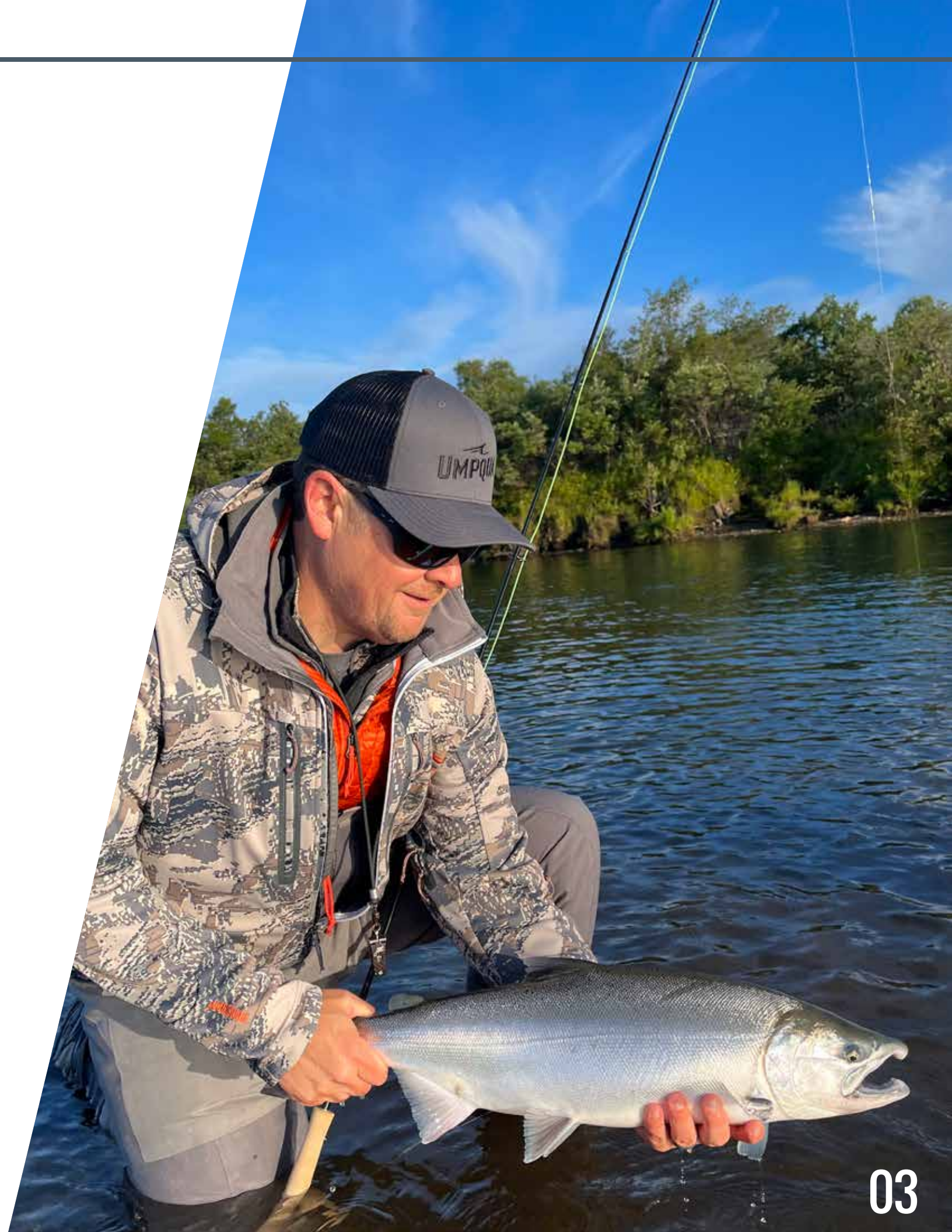

A person wearing a plaid shirt, shorts, and a hat is standing on a large rock in a river, fishing. The river is filled with large rocks and the water is a deep, dark green color. The person is holding a fishing rod and a line that extends into the water. The background shows more rocks and the continuation of the river.

OUR VISION

TO GIVE PEOPLE THEIR BEST DAY ON THE WATER.

OUR MISSION

TO MAKE ALL ANGLERS BETTER THROUGH PASSION, EDUCATION,
AND RELENTLESS INNOVATION

PASSION

WE SHARE OUR LOVE AND APPRECIATION OF THE OUTDOORS

WE BELIEVE IN WORKING HARD AND PLAYING HARD AND THAT LIFE IS BETTER OFF A DIRT ROAD. WE BELIEVE IN AUTHENTIC EFFORTS TO PRESERVE THE WILD PLACES THAT MAKE US FEEL ALIVE.

INNOVATION

BREAK IT...MAKE IT BETTER

WE BELIEVE IF IT AIN'T BROKE, WE SHOULD BREAK IT...AND MAKE IT BETTER. WE BELIEVE IN CUTTING-EDGE PRODUCTS, SYSTEMS, SERVICES AND BUSINESS SOLUTIONS FOR OUR CUSTOMERS AND NEVER UNDERESTIMATING OUR COMPETITION.

HONOR

ONE WAY TO DO THINGS, THE RIGHT WAY! DO THE RIGHT THING

WE BELIEVE IN THE HIGHEST LEVEL OF INTEGRITY WHICH PEERS, CUSTOMERS AND EVEN COMPETITORS CANNOT DISPUTE NOR QUESTION. WE BELIEVE IN EXTREME OWNERSHIP...BEING TRUE TO OUR WORD AND OWNING OUR ACTIONS AND ATTACKING TOUGH SITUATIONS HEAD ON, WITH CANDOR AND KINDNESS.

FAMILY

ABOVE ALL, WE'RE A TEAM

WE BELIEVE IN PLAYING FOR EACH OTHER. THAT MEANS WE SHOW UP FOR EACH OTHER, ACT WITH EMPATHY AND HUMILITY. BRING OUR AUTHENTIC SELVES TO WORK EVERY DAY - WE ARE GROWING THIS COMPANY NOT FOR OUR OWN PERSONAL GAIN BUT FOR EACH OTHER'S. WE ARE COMMITTED TO THE GROWTH AND HAPPINESS FOR OUR FAMILY OF EMPLOYEES, DEALERS, FLY DESIGNERS, GUIDES, AND ANGLERS. WE BELIEVE IN BRINGING JOY TO OUR FAMILY EVERY DAY. LAUGH, BE GRATEFUL, POSITIVE, AND HOSPITABLE.

CUSTOMER

WITHOUT THE CUSTOMER, WE DON'T EXIST...ACT LIKE IT, EVERYDAY

WE BELIEVE THAT OUR CUSTOMERS DESERVE THE VERY BEST, AND IT'S OUR JOB TO GIVE IT TO THEM. WHEN A CUSTOMER HAS A PROBLEM, IT'S A BIG DEAL...LISTEN AND FIX IT. OUR BUSINESS IS COMPLEX AND WE BELIEVE IN GOING THE EXTRA MILE TO MAKE SURE OUR CUSTOMER DOESN'T FIND OUT.

TERMS OF SALE

PRICE: All prices in this catalog are base unless otherwise noted. Umpqua Feather Merchants must approve any variation from these prices in writing. All prices are subject to change without notice.

TERMS: Pre-pay until credit has been approved. All purchasers are subject to a credit approval. If the Company determines a purchaser's credit and/or payment history is insufficient, terms will be net cash in advance or COD. Customers cannot exceed their account credit limit.

Pre-authorization of credit cards will be obtained when order is placed on all Prepay orders. This pre-authorization may place a hold on funds in the account depending on your banks requirements.

PAST DUE ACCOUNTS: A service charge of 2.0% per month on all unpaid balances will be charged on all past due accounts. These charges will not exceed 24% annually. Discounts can only be taken if an account has no past due invoices or unpaid finance charges.

Accounts over 90 days past due are subject to being sent to Collections. Purchaser will be responsible for all related collection costs including attorney fees and court costs on all invoices not paid within terms.

TERMS ARE SUBJECT TO CHANGE WITHOUT NOTICE.

DISCOUNTS: Discounts can only be taken on finished product costs. Freight charges, pallets, document fees, etc. are not discountable items. Discounts can only be taken if an account has no past due invoices or unpaid finance charges.

ORDERS: The minimum order required to open an account is \$750. All products are sold by units or case lots as described in the catalog. All orders are subject to acceptance by Umpqua Feather Merchants. **Upon such acceptance, without further notice to the customer, the order becomes a valid contract governed by the laws of the state of Colorado.**

1-800-322-3218
WWW.UMPQUA.COM
UMPQUA@UMPQUA.COM

UMPQUA FEATHER MERCHANTS
594 S. ARTHUR AVE., LOUISVILLE, CO 80027
303-567-6696 8:00 AM - 5:00 PM MST
E-FAX: 303-865-3931 PHYSICAL FAX: 303-567-6697

RETURNS: No returns are accepted without prior authorization from Dealer Services and a corresponding return authorization number. The return authorization number must be displayed on the box containing the return or it will be refused and returned to sender. Merchandise accepted for return must be returned in the original packaging. Returns may be charged a 15% re-stocking fee. Damaged or unsatisfactory goods must be returned within 10 days of receipt to receive a credit for the full invoice price. A credit of 85% of the current price, or invoice price, will be the only credit allowed for merchandise returned after 10 days of receipt.

SHIPPING: All products ship F.O.B. Louisville, CO.

SHORTAGES/IMPROPER PRICING: Customer has 10 days following date of invoice to notify Umpqua Feather Merchants of any questions concerning shortages, terms or discount. Unless Umpqua Feather Merchants is so notified, it is understood and accepted that the invoice is correct, due and payable under the terms and conditions stated herein. In the event a proof of delivery is requested a 2% charge will be incurred. This charge will be waived on any undelivered shipment.

REVISIONS AND CANCELLATIONS: If customers fail to accept the merchandise according to the program as outlined, all privileges under this program are forfeited. We reserve the right to refuse service at our discretion.

Cancellations and/or Revisions to orders must be made 21 days before original ship date.

All early order back orders will be canceled 120 days after their initial ship date unless a cancel date had been specified by the customer.

ORDERS ARE NOT GUARANTEED: Umpqua Feather Merchants will make every effort to deliver orders on time and as complete as possible, but does not guarantee this. Customer satisfaction is our mission, but no employee or representative of Umpqua Feather Merchants has any authority to guarantee shipments. Customers release Umpqua Feather Merchants from any liability in connection with an order not being delivered on time or being incomplete.

CALIFORNIA PROPOSITION 65: Umpqua Feather Merchants has implemented measures to comply with the California Safe Drinking Water and Toxic Enforcement Act of 1986 and associated regulations (collectively, "Proposition 65"), which require warnings with certain products sold to California consumers. Dealer shall indemnify, defend, and hold harmless Umpqua Feather Merchants, LLC for any harm or loss (including financial penalty) resulting from Dealer's non-compliance with Proposition 65 or Dealer's failure to take the actions laid out in Umpqua Feather Merchants notices to Dealer regarding in-store and online Proposition 65 warnings.

TERMS & CONDITIONS

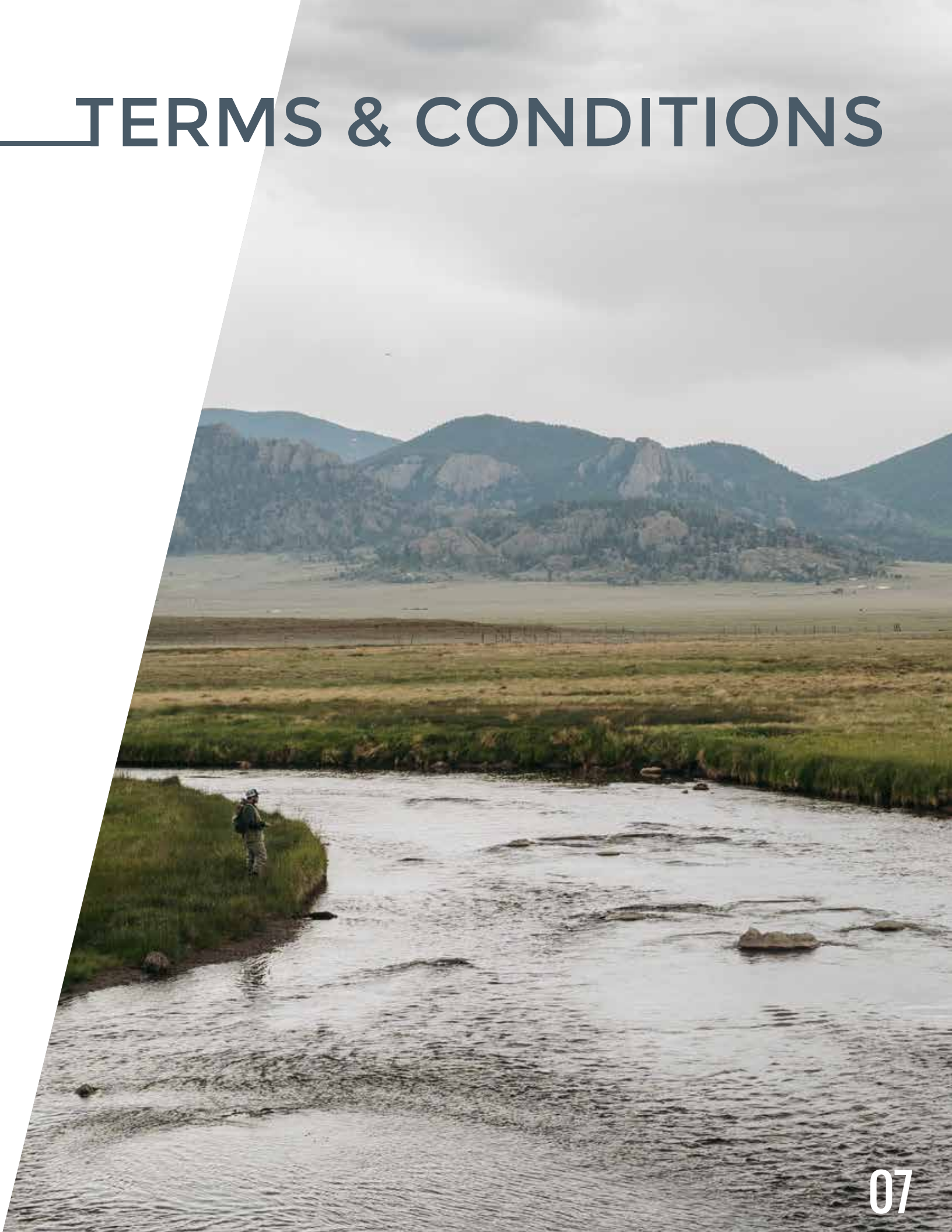

SIGNATURE TYERS

In the 1970's, Dennis Black, Umpqua's founder, put in motion an idea that would grow into the world's largest fly company. Dennis, a well-respected fly tyer and fishermen developed friendships with many of the sport's greats, including: Randall Kaufmann, Mike Lawson, Andre Puyans, E.H. Polly Rosborough, Larry Dahlberg and Gary LaFontaine. Through these friendships, Dennis curated the most sought after fly designs and started, what is now, Umpqua's Signature Designer program.

The majority of Umpqua's fly assortment is designed through these Signature Tyers. Hundreds of fly fishermen yearly send Umpqua their designs in hopes to become part of the Signature Tyer family. Brent Bauer, a Signature Tyer himself, oversees the whole Signature program, and is dedicated to making the program successful. Umpqua's fly selection committee meets quarterly to decide which flies will be included in the catalog. After the flies have been selected, our tyers are put under contract to receive royalties for their design. Each fly is produced to the specificity and is guided by the Signature Tyer. The relationship with the the Tyers is the backbone of the Umpqua business and speaks to the nature of the Umpqua name. With over 200 Signature Tyers currently in the program, Umpqua aims to spur on fly innovation and creativity by continuing this tradition in the years to come.

Umpqua flies carry a rich history of tradition, quality and innovation—designed by fly fishermen for fly fishermen. Fly fishing is built on the fly; that seemingly small piece of gear is what connects man to prey. Without the fly, all fish stories would be the tallest of tales.

If you think you have what it takes to join the most prominent and prestigious Signature Fly Designer Program in the industry, we'd love to see what you've got.

To find out how, contact us at umpqua@umpqua.com or call us at 800.322.3218.

NEW 2024 TYERS



**BEN
BAXTER**



**JON
EASDON**



**BRANDON
FELLER**



**ANDREW
LARAWAY**



**MICHAEL
MCGOVNEY**



**PAUL
RUSSELL**



**ZACHARY
TOKACH**





**NICK
ADLER**



**BRANDON
ALEXANDER**



**GEORGE
ANDERSON**



**MICKY
ANDERSON**



**ROB
ANDERSON**



**RUSSELL
ANDERSON**



**JEFF "BEAR"
ANDREWS**

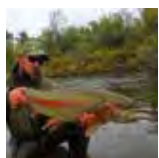

**DANIEL
ARMSTRONG**



**TROY
BACHMANN**



**THEO
BAKELAAR**



**DAVE
BALLOK**



**JOHN
BARR**



**BRENT
BAUER**



**BEN
BAXTER**



**BARRY
BECK**



**CATHY
BECK**

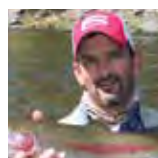

**BRAD
BEFUS**



**MATT
BENNETT**



**A.K.
BEST**

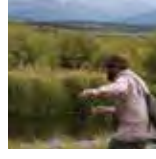

**TODD
BIRCHBY**



**BRET
BISHOP**



**JOE
BLADOS**



**GREG
BLESSING**



**DAN
BLANTON**



**MATT
BLUMENSHINE**



**JOHN
BOND**



**TODD
BOYER**



**CALEB
BOYLE**



**ANDY
BURK**

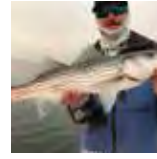

**ALEX
CADY**



**JIM
CANNON**



**MICHAEL
CARANCI**



**DREW
CHICONE**



**DAVE
CHOUINARD**



**YVON
CHOUINARD**

SIGNATURE TYERS



DENNIS
COLLIER



HERMAN
DEGALA



LANCE
EGAN



JOHNNY
GOMEZ



MIKE
CONNER



JACK
DENNIS



MARK
ENGLER



MICHAEL
GORMAN



RILEY
COTTER



GARRISON
DOCTOR



BRANDON
FELLER



JOSH
GRAFFAM



HENRY
COWEN



FORREST
DORSEY



BILL
FOWLER



ANDREW
GRILLOS



CHARLIE
CRAVEN



PAT
DORSEY



TIM
FOX



SHEA
GUNKEL



RALPH
CUTTER



PATRICK
DORSEY



AARON
FREED



DUANE
HADA



LARRY
DAHLBERG



TIM
DRUMMOND



GREG
GARCIA



TIM
HADDON



KEVAN LEE
DAVIDSON



DARYL
EAKINS

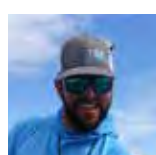

ALEC
GERBEC



LARRY
HAINES



SCOTT
DAVIS

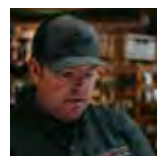

JON
EASON



ZACH
GINOP



RANDY
HANNER



ANDRIJ
HORODYSKY



RANDALL
KAUFMANN



DAN
LECOUNT



CHRIS
HANSEN



MARTY
HOWARD



BRIAN
KELSO



ANDY
LEISTER



RON
HART



BRIAN
HUDSPETH



ZACH
KING



BOB
LEMAY



PIERRE
HEBERT



MIKE
HUFFMAN



LEE
KINSEY



BILL
LOGAN



TIM
HENG



PHIL
IWANE



TOM
KINTZ

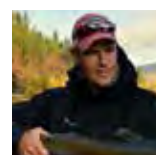

BRAD
LOVEJOY



JEFF
HICKMAN



BLAKE
JACKSON



DAVID
KNOWLES

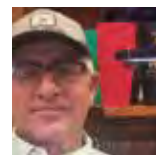

STEVE
MALDONADO



MARK
HIERONYMUS



ANTHONY
JANIK



DANNY
LANE



NORMAN
MAKTIMA



LEX
HOCHNER



FRANS
JANSEN



ANDREW
LARAWAY



CRAIG
MATHEWS



DEC
HOGAN



CHRIS
JOHNSON



MIKE
LAWSON



LANDON
MAYER

SIGNATURE TYERS



**RON
MAYFIELD**



**JOE
MESSINGER**



**HARRY
MURRAY**



**LUKE
PANZARELLA**



**MATT
MCCANNEL**



**BRAD
MILLER**



**TIMOTHY
NEAL**



**ERIC
PARAMORE**



**MICHAEL
MCGOVNEY**



**DENNIS
MILLER**



**ALAN
NEALLEY**



**STEVE
PARROTT**



**DAVE
MCKEE**



**JOSH
MILLS**



**WALTER
NEWMAN**



**CHRIS
PASSAGE**



**DOUG
MCKNIGHT**



**TYLER
MILLS**



**JONATHAN
OLCH**



**ERIC
PAULSON**



**MICHAEL
MCLELLAN**



**MARK "POPS"
MILLER**



**DEVIN
OLSEN**



**MATT
PEDERSON**



**BRANDON
MENA**



**SANDY
MORET**



**DOUG
OUELLETTE**



**TRACY
PETERSON**



**MIKE
MERCER**



**CRAIG
MORGAN**

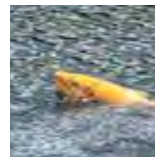

**BRIAN
OWENS**



**ERIC
PETTINE**



**GARY
MERRIMAN**



**WILLIAM
MURDICH**



**TRAVIS
ORTIZ**



**JIM
PETTIS**



DAVID PHARES



J.J. PILGREEN



DENNIS POTTER



KEVIN PRICE



TYLER REED



CLARK REID



STEVEN RENDLE



BARRY REYNOLDS



DANIEL ROBERTS



SCOTT ROBERTSON



BRYAN ROBINS



ANTONIO RODRIGUES

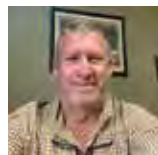

MATT ROSENTHAL



PAUL RUSSELL



WILL SANDS



ART SCHECK



JACK SCHLOTTER

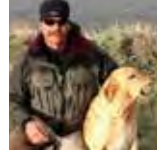

CHRIS SCHRANTZ



ED SCHROEDER



MIKE SEXTON

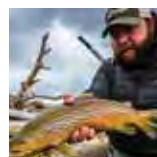

PETE SHANAFELT



KEN SHIMAZAKI



BRIAN SILVEY



DAVID SKOK



DAVID SLOAN

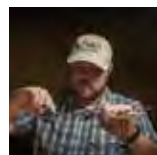

JOSH SMITHERMAN



RYAN SPILLERS



CAPTAIN RAY STACHELEK



CARL STOUT



BOB STREB



RICK TAKAHASHI



MORGAN THALKEN



GORDON THARRETT



SCOTT THOMPSON



ZACK THURMAN

SIGNATURE TYERS



ZACHARY
TOKACH



FRANK
WHISPELL



GUY
TURCK



VINCE
WILCOX



JOSH
VAN WOERT

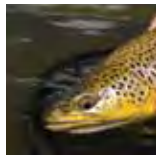

EDDIE
WYATT



ZACH
VANDEHEY



JOHN
YANKANICH



BOB
VEVERKA



JASON
YEAGER



TIM
WADE



JAY
ZIMMERMAN



CLIFF
WATTS



HANS
WEILENMANN



JEFF
WHITE

IN MEMORY OF:

CAL BIRD
DEL BROWN
DAN CALLAGHAN
ART FLICK
JOHN FUCHS
CHUCK KRAFT
LARRY KINGREY
GARY LAFONTAINE
MICHAEL MCGINN
MOANA
SYLVESTER NEMES
FRANK OLIVERIO
DON PUTERBAUGH
BOB QUIGLEY
NATE REYNOLDS
PAGE ROGERS
JIM STEWART
DAVE STUDENT
DAVE WHITLOCK

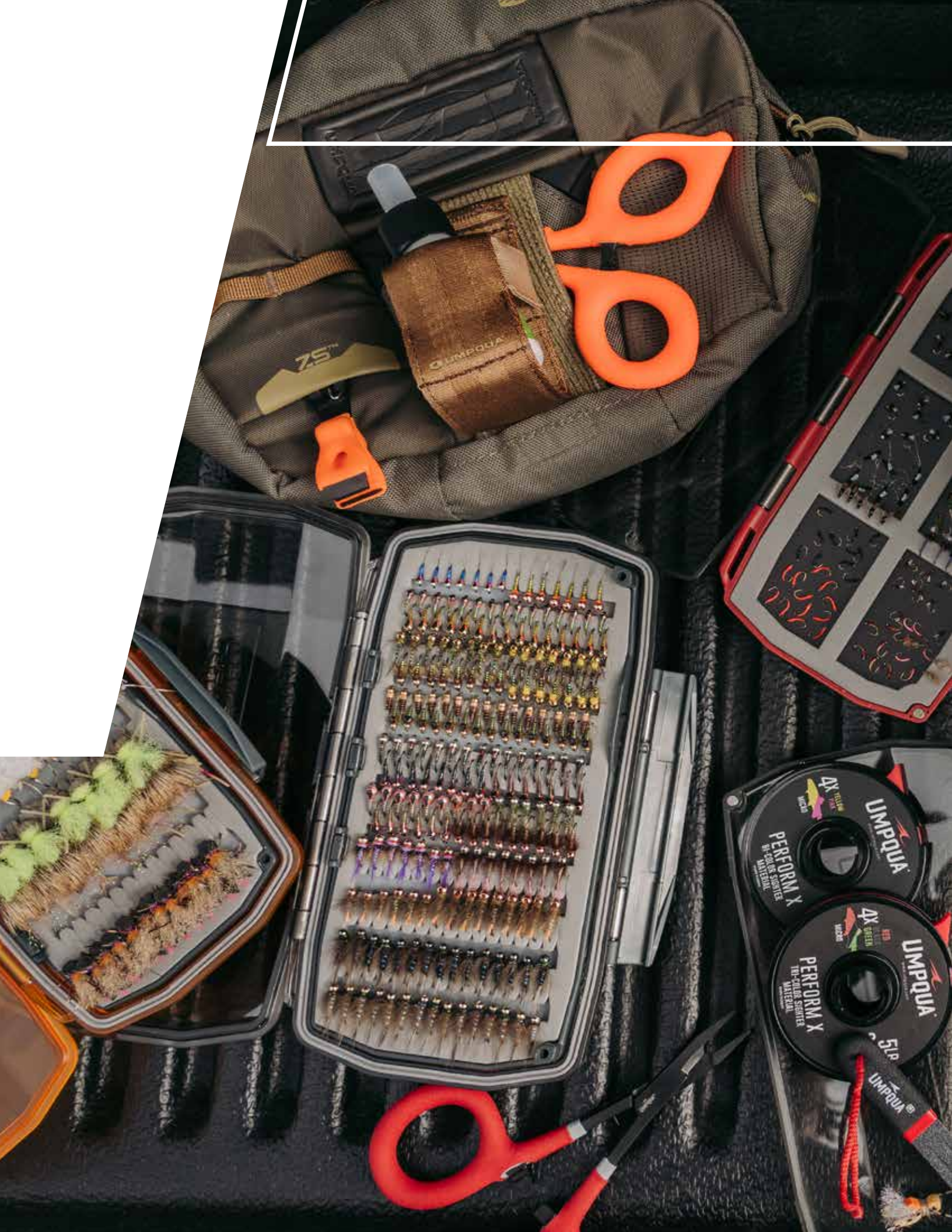

NEW PRODUCT

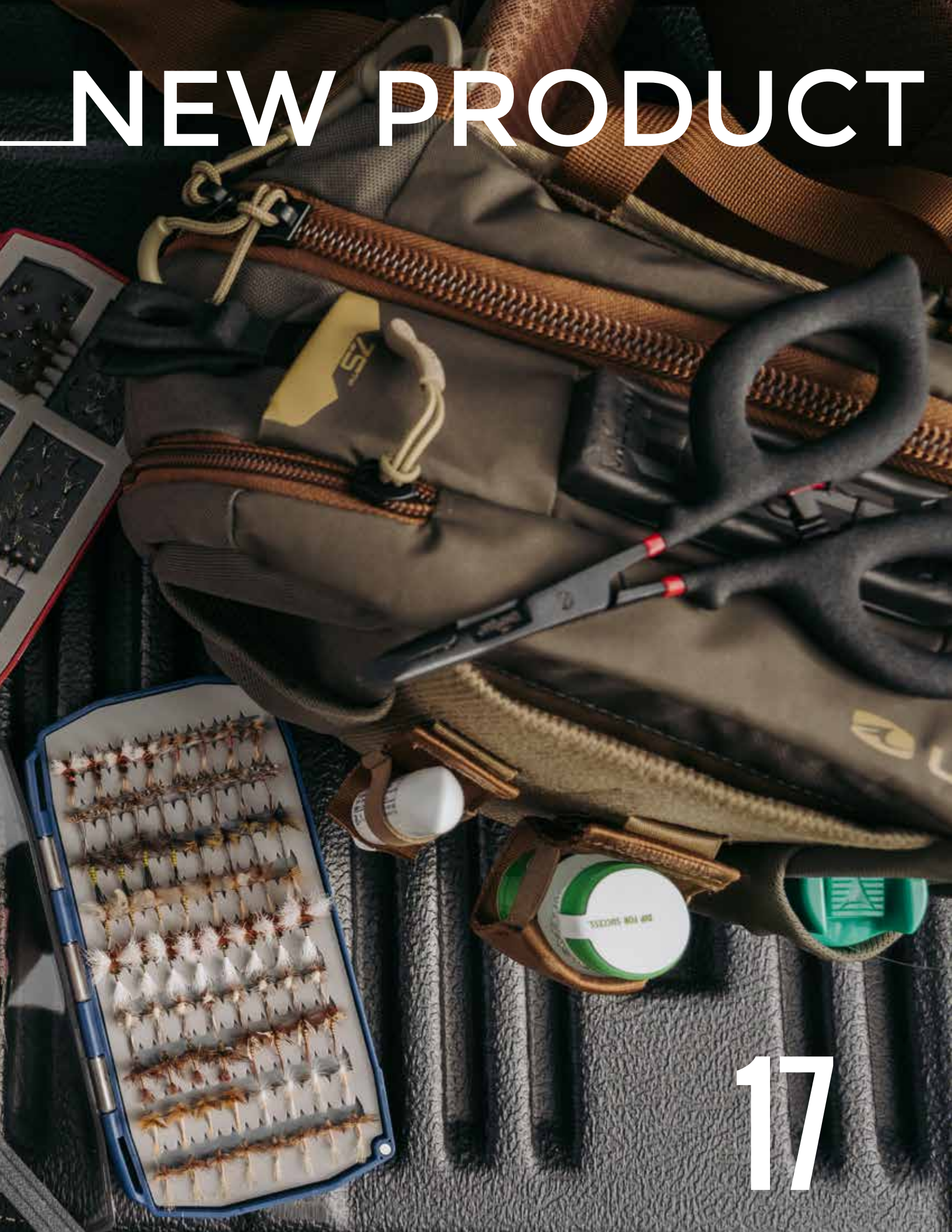

17

DRY/ TERRESTRIAL



CORN-FED SPRUCE MOTH

TIED BY SIGNATURE TYER
LANCE EGAN

MENTION THE TERM "TERRESTRIALS", AND ANGLERS ENVISION HOPPERS, ANTS, BEETLES, CRICKETS, AND MAYBE EVEN CICADAS, BUT RARELY DO WE ANGLERS THINK ABOUT MOTHS. LATE SUMMER TO EARLY FALL, THE SPRUCE MOTH HATCH CAN BE HAPPENING ANYWHERE THERE ARE FIR OR SPRUCE TREES LINING ROCKY MOUNTAIN RIVERS & LAKES. THE CORN-FED SPRUCE MOTH IS AN IMITATIVE PATTERN THAT USES THE NATURAL FLOATATION AND IRRESISTIBLE NATURE OF CDC TO ENTICE TROUT. IF YOU'RE HEADING TO THE HIGH COUNTRY IN LATE SUMMER DON'T BE CAUGHT WITHOUT A FEW CORN-FED SPRUCE MOTHS.

SIZES AVAILABLE: 10-16
CODE E PAGE 68



CRANEFLY

MR. JONES

TIED BY SIGNATURE TYER
CHARLIE CRAVEN

THE MR. JONES IS THE RESULT OF YEARS OF TRYING TO COME UP WITH A PATTERN TO MATCH NOT ONLY THE PROFILE OF A LARGE, SKATING ADULT CRANEFLY, BUT TO DEVELOP A FLY THAT WOULD SKATE AND DANCE THE WAY THE NATURALS DO. LIKE SO MANY GOOD FLIES, THIS ONE COMBINES PARTS FROM A COUPLE PREVIOUS PATTERNS, NOTABLY MY LUCKY B AND THE INFAMOUS SCREAMING BANSHEE. THE RESULT IS A FLY THAT NOT ONLY LOOKS GOOD, BUT FISHES EVEN BETTER. WITH A UNIQUELY FORMED EXTENDED BODY THAT WILL FOLD UP WHEN A FISH EATS IT AND A FORWARD FACING MOOSE HAIR WING, THE MR. JONES IS HONESTLY ONE OF THE MOST FUN FLIES I HAVE EVER FISHED. SKATED DOWN AND ACROSS OR EVEN STRIPPED LIKE A STREAMER ON TOP JUST STRAIGHT OFF THE BANK, THE VISUAL FOLLOWS AND ATTACKS THIS FLY PROMPTS ARE SECOND TO NONE.

SIZES AVAILABLE: 10, 14
CODE H PAGE 77



BWO

PABLO'S CRIPPLE

TIED BY SIGNATURE TYER
PAUL RUSSELL

PABLO'S CRIPPLE IS A PERFECT MAYFLY IMITATION FOR PICKY FISH IN TECHNICAL TAILWATERS AND FREESTONES ALIKE. THE FLY WAS DEVELOPED ON THE YAMPA RIVER IN STEAMBOAT, CO. WHETHER THE FISH ARE KEYED IN ON A TOUGH SPINNER FALL OR ONLY EATING CRIPPLED EMERGERS, PABLO'S CRIPPLE HAS YOU COVERED FOR ANY HATCH OF TRICOS, BWO'S, AND PMD'S. THE TRICO COLOR ALSO DOUBLES AS AN EXCELLENT MIDGE DRY IN THE SMALLER SIZES. YOU CAN FISH THIS PATTERN DRY, IN THE SURFACE FILM, OR FISHED DEEP AND FIND SUCCESS ON YOUR LOCAL WATERS.

SIZES AVAILABLE: 16-22 VARIED BY COLOR
CODE DD PAGE 78



PMD TRIDGE



HEX

STEALTH LINK

TIED BY SIGNATURE TYER
MIKE MERCER

A COUPLE OF YEARS AGO, FISHING A PALE MORNING DUN EMERGENCE ON A FAVORITE STRETCH OF NORTHERN CALIFORNIA'S HAT CREEK, I WAS SHOCKED TO EXPERIENCE THE HYPER-SELECTIVE RAINBOWS REFUSING MY MISSING LINK. EVERY STEADY RISER WOULD TAKE A CLOSE LOOK, BUT ONLY ONE IN FIVE WOULD TAKE IT, INSTEAD OF THE 80-90% SUCCESS RATE I'M USED TO. IT SEEMED THAT THE FISH HAD ENOUGH NATURALS TO CHOOSE FROM THAT MANY WERE KEYING IN ON EMERGERS STILL ATTACHED TO THEIR SHUCKS, INSECTS THAT WERE TRULY HELPLESS FOR SEVERAL SECONDS AS THEY DRIFTED ON THE SURFACE. NOT NEEDING TO REINVENT THE WHEEL, I SIMPLY ADDED A TWO-PART SOFT SHUCK TO MY MISSING LINK, AND SUBSTITUTED A QUILL BODY IN PLACE OF THEIR ORIGINAL'S THREAD AND FLASHABOU ABDOMEN. THOSE HAT CREEK FISH NEVER KNEW WHAT HIT 'EM!

SIZES AVAILABLE: 6-22 VARIED BY COLOR
CODE H-J PAGE 82, 150



GREEN DRAKE BWO CALLIBAETIS PMD



BLACK

BIG FAT AUNT

TIED BY SIGNATURE TYER
CHRIS JOHNSON

NO AVID ALPINE FLY ANGLER WILL REFUTE THE EFFECTIVENESS OF A CARPENTER ANT IMITATION IN THE SUMMER. PRESENTING THIS FLY TO CUTTHROAT IN THE SMALLEST OF STREAMS, AS WELL AS HIGH MOUNTAIN LAKES, CAN BE ABSOLUTELY DEADLY. HOWEVER, I HAVE FOOLED MANY LARGER, MORE DISCERNING TROUT ON THE PATTERN AS WELL. THE FLY'S DOUBLE-STACKED FOAM ABDOMEN HELPS IT REMAIN HIGH AND DRY THROUGHOUT THE DAY. THE HACKLE AND LEGS TRULY PERFECT THE PROFILE MAKING IT AN ACCURATE REPRESENTATION OF THE GENUINE ARTICLE. GIVE THE BIG FAT AUNT A TRY AND IT WILL FIND A PERMANENT PLACE IN YOUR FLY SELECTION AS WELL!

SIZES AVAILABLE: 12-16
CODE F PAGE 86



CARPENTER FIRE



RED

CHUBBY CUBBY

TIED BY SIGNATURE TYER
KEVAN DAVIDSON

THE THREE-SECTION CUPBOARD ANT HAS ALWAYS BEEN MY FAVORITE CONFIGURATION OF THE CUPBOARD ANT, WHICH WAS BORN OUT OF A TOP-OF-MIND NEED TO CREATE NEW FLY PATTERNS TO IMITATE CARPENTER ANTS IN ROCKY MOUNTAIN NATIONAL PARK. MARRYING THE CHUBBY STYLE WING TO THE SHINY SILHOUETTE OF THE CUPBOARD ANT WAS A NO BRAINER, WHICH IS WHY I CALLED THIS CUPBOARD ANT VARIATION THE CHUBBY CUBBY. I HAVE FISHED THE CHUBBY CUBBY FOR MANY YEARS WITH GREAT SUCCESS IN LAKES AND RIVERS AS A STIMULATOR PATTERN BY ITSELF OR WITH A TAILING DRY FLY OR SMALL DROPPER.

SIZES AVAILABLE: 16
CODE F PAGE 87



BLACK BROWN RED/BLACK

NEW FLIES

TERRESTRIALS



PURPLE

FANCY PANTS HOPPER TIED BY SIGNATURE TYER ERIC PARAMORE

THE INSPIRATION FOR THE FANCY PANTS HOPPER CAME FROM YEARS OF OBSERVATION OF ACTUAL MONTANA GRASSHOPPERS. THE MAIN DIFFERENCE BETWEEN THIS PATTERN AND OTHER HOPPER PATTERNS IS THAT THE THORAX, WING AND LEGS ARE ONE PIECE OF FOAM CREATING A SIMPLE, SUPER REALISTIC PROFILE, SOMETHING I HAVE BEEN TRYING TO ACHIEVE SINCE THE CREATION OF MY ORIGINAL THUNDER THIGHS HOPPER. THIS HOPPER LOOKS LIKE THE REAL THING FROM ALL ANGLES AND GETS FEWER LATE SEASON REFUSALS THAN OTHER BULKY PATTERNS. TIED ON THE BEEFY TIEMCO 5262 HOOK, THIS FLY LANDS UPRIGHT AND HOLDS TIGHT.

SIZES AVAILABLE: 8-14
CODE I PAGE 90



GOLDENROD PINK TAN



BLACK

SEED BEETLE TIED BY SIGNATURE TYER BRANDON FELLER

THE SEED BEETLE WAS CREATED OUT OF NECESSITY. THERE WASN'T A PATTERN IN THE FLY SHOPS THAT ACCURATELY IMITATED THE INSECTS I WAS SEEING ON THE RIVER. WESTERN CONIFER SEED BUGS HAVE BECOME AN IMPORTANT TERRESTRIAL INSECT ON MY HOME RIVER THE GREEN, AS WELL AS MANY OF THE RIVERS I FISH IN THE WESTERN UNITED STATES, AND FISH LOVE THEM. PERHAPS IT IS BECAUSE OF THE PHEROMONE THESE INSECTS CONTAIN. THE PATTERN WAS DEVELOPED TO SIT LOW IN THE SURFACE FILM, BE HIGHLY VISIBLE, AND BUOYANT. IT ALSO DOES A GREAT JOB OF IMITATING MANY BEETLE SPECIES.

SIZES AVAILABLE: 8-14
CODE F PAGE 89



BROWN



RUST

LAST GASP ANT TIED BY SIGNATURE TYER PHIL IWANE

THE IDEA WAS TO MAKE THIS ANT APPEAR TO BE DROWNING. THE TMC 2488 WAS THE PERFECT HOOK. THE NEXT PART OF THE DESIGN WAS THAT IT LOOKED REALISTIC. I TIE THE LAST GASP ANT IN TWO COLORS, BLACK AND RUST. THE LAST GASP ANT WAS DESIGNED AS A DRY FLY SO IT WAS IMPORTANT THAT TOP PORTION OF THE FLY WOULD FLOAT ON TOP OF THE FILM OF THE WATER AND THAT THE ABDOMEN AND THE THORAX WOULD BE IN THE FILM. TO SUPPORT THIS PATTERN, I DECIDED TO TIE IT WITH A PARACHUTE WHICH APPEARS TO BE THE WING OF THE ANT AND THE POST MAKES IT VISIBLE TO THE FLY FISHER. WHEN I FISHED IT, MY LAST GASP ANT PERFORMED JUST AS IT HAD BEEN DESIGNED. MOST IMPORTANTLY IS THAT IT CAUGHT FISH IN GOOD NUMBERS WHICH IS THE GOAL OF ALL DESIGNED FLIES.

SIZES AVAILABLE: 14-18
CODE F PAGE 87



BLACK



PURPLE

TL HOPPER TIED BY SIGNATURE TYER ZACHARY TOKACH

THE IDEA CAME ABOUT CREATING A HOPPER STYLE FLY THAT WAS UNIQUELY WEIRD! I WANTED THE PATTERN TO BE "NERVOUS ON THE SURFACE" HENCE THE UNORTHODOX REAR LEGS WHICH ARE NOT TYPICAL HOPPER LEGS BUT BUGGY! I WANTED THE PATTERN TO BE ABLE TO BE FISHED AMONGST BEETLES AND SPIDERS OR WHATEVER NON ESCAPING TREATS ARE ON YOUR WATER. AND WITH FOUR COLORS AND THREE SIZES TO CHOOSE FROM THERE'S A TL FOR WHATEVER TYPE OF WATER YOU'RE ON!

SIZES AVAILABLE: 6-10
CODE K PAGE 91



CINNAMON YELLOW ROYAL



GOLDEN

NAKED CHUBBY

WITH THE EVER-GROWING POPULARITY OF THIS FLY PATTERN, UMPQUA HAS DECIDED TO LEAN ON ITS EXPERIENCE WITHIN THE INDUSTRY AND PUT AN INNOVATIVE SPIN ON THIS CLASSIC. OUR GOAL IS TO GIVE ANGLERS ANOTHER OPTION TO FISH A CONFIDENCE PATTERN WHEN THE FISH HAVE ALREADY SEEN TOO MANY BIG FLUFFY WHITE WINGS FLOATING ABOVE THEM. THE NEW "NAKED CHUBBY" COMBINES A MORE SLENDER UNDERBODY PROFILE WITH SOME HOLOGRAPHIC FLASH TO STILL GRAB FISH'S ATTENTION, WHILE THE TONAL WING BLENDS GIVE ANGLERS A STEALTHIER APPROACH TO WARY FISH AND MORE CLOSELY RESEMBLE THE TRUE WING COLORS OF NATURAL INSECTS.

SIZES AVAILABLE: 6-16
CODE DD PAGE 77, 93



ORANGE PURPLE TAN OLIVE ROYAL

NYMPHS



OLIVE

BEARDED BAETIS

TIED BY SIGNATURE TYER
BEN BAXTER

WITH THIS FLY I WAS REALLY LOOKING TO GET A LOT OF WEIGHT PAIRED WITH A LITTLE MORE OF AN AGGRESSIVE PROFILE (TAPER) TO THE FLY. I WENT WITH A NATURAL COLOR APPROACH INITIALLY AND THEN ADDED THE COLORED RESIN. I ALSO WANTED TO GET SOME MOVEMENT IN THE FLY WITH THE LEGS (OR THE BEARD) WITH THE OSTRICH HERL. AFTER JIG HOOKS STARTED TO BECOME MORE POPULAR, ALONG WITH THE EURO NYMPHING SCENE, I DECIDED TO PUT THE PATTERN TO A JIG HOOK. I HAVE USED IT UNDER AN INDICATOR FOR NYMPHING DEEP RUNS. IT CAN BE USED AS A POINT FLY IN A LARGER SIZE OR A DROPPER FLY IN A SMALLER SIZE ON A STANDARD EURO NYMPHING RIG.

SIZES AVAILABLE: 16, 18

CODE K PAGE 104, 129



BLACK VELVET

TIED BY SIGNATURE TYER
MIKE SEXTON

THE BLACK VELVET CAME ABOUT WHEN RILEY COTTER AND I WERE COMPETING TOGETHER AT ONE OF OUR NATIONAL CHAMPIONSHIPS. I HAD SOME PHEASANT TAILS THAT I DYED WITH A COLOR CALLED BLACK VELVET FOR A CERTAIN CHIRONOMID PATTERN AND WE PUT OUR HEADS TOGETHER FOR THIS JIG FLY BACK AROUND 2009. THIS FLY IS STILL ONE OF MY GO TO PATTERNS IN COMPETITIONS AND WHENEVER I'M FISHING.

SIZES AVAILABLE: 12-18

CODE F PAGE 104, 129



BUCKSKIN JIG

TIED BY SIGNATURE TYER
FORREST DORSEY

THE BUCKSKIN JIG IS AN UPDATE TO FEATURES THE OF THE TRADITIONAL BUCKSKIN. THE BUCKSKIN JIG IS TIED ON AN UMPQUA X-SERIES 400BL JIG HOOK AND OFFERS A HEAVY SLOTTED TUNGSTEN BEAD, SLIM PROFILE AND A BIT OF FLASH IN THE THORAX TO TRICK EVEN THE PICKIEST TROUT. THE BUCKSKIN JIG FISHES WELL ANYWHERE THERE ARE FREE-LIVING CADDIS, AND CAN DOUBLES AS A MIDGE LARVA IN SMALLER SIZES. THE BUCKSKIN JIG CAN ALSO BE USED IN SUMMER AS AN EFFECTIVE DROPPER IN A DRY-DROPPER SETUP. I'VE FOUND THIS FLY TO BE VERY PRODUCTIVE ON EVERY TAILWATER I HAVE EVER FISHED, BUT IT EXCELS ON THE SOUTH PLATTE.

SIZES AVAILABLE: 14-18

CODE E PAGE 105, 129



PURPLE



GRAY WING

CDC CASED CADDIS JIG

TIED BY SIGNATURE TYER
FORREST DORSEY

THE CDC CASED CADDIS JIG IS A TWIST ON THE POPULAR CASED CADDIS THAT IMITATES BRACHYCENTRUS CADDIS LARVAE, WHICH ARE EASILY IDENTIFIED BY THEIR BROWN, RECTANGULAR, TAPERED CASES.

I TYPICALLY FISH THIS PATTERN ON LARGER TAILWATERS WITH HEAVIER NYMPHING RIGS BUT, IT FISHES WELL ON FREESTONES TOO. DON'T SLEEP ON THIS PATTERN AS A DROPPER IN A DRY-DROPPER APPLICATION, AS I'VE FOUND IT TO BE VERY SUCCESSFUL IN HIGH ELEVATION CREEKS SEARCHING FOR NATIVE BROOK TROUT.

THE CDC CASED JIG IS ABOUT AS BUGGY AS IT GETS. I MIGHT BE A SUCKER FOR ANYTHING TIED WITH CDC, BUT SO ARE THE FISH!

SIZES AVAILABLE: 14, 16

CODE G PAGE 106, 130



BLACK

FLEXY STONE

TIED BY SIGNATURE TYER
GARRISON DOCTOR

YOU MAY HAVE SEEN THIS MATERIAL ON SOME SEXY SALTWATER CRABS, BUT THIS MATERIAL IS GREAT IN FRESHWATER AS WELL! THIS UNIQUE MATERIAL USAGE ON MY FLEXY STONE CREATES A REALISTIC PROFILE WITH GREAT WING CASE DEFINITION, DIFFERENTIATING IT FROM CLASSIC CHENILLE WRAPPED STONEFLY PATTERNS. THE TRANSLUCENT QUALITY OF THE TUBING IMPARTS REALISM IN THE WATER, SHOWS THROUGH TO THE BEAD SEGMENTATION IN THE ABDOMEN AND THE LONG LEGS FOR MOVEMENT SEAL THE DEAL. THE FLY IS EXTREMELY DURABLE AND WILL FISH GREAT WHEREVER BIG STONEFLIES CRAWL!

SIZES AVAILABLE: 4-8

CODE F PAGE 107



GOLD/ BROWN



PMD

GINGER SNAP

TIED BY SIGNATURE TYER
ANDREW LARAWAY

WHEN THERE ARE TROUT TO BE CAUGHT SUBSURFACE, THE GINGER SNAP IS A GO TO. WITH A MIX OF YELLOW CDC AND UV ICE DUB IN THE COLLAR AND A SLIM SULPHUR ORANGE QUILL BODY, THIS FLY IS A NO BRAINER WHEN PMDS ARE POPPING OFF. I WANTED SOMETHING THAT WOULD WORK AROUND ALL THE RIVERS IN NORTHERN CALIFORNIA AND PMDS ARE A VERY COMMON BUG THAT CAN BE ABUNDANT IN THE AREA. TRIED AND TRUE, THIS JIGGED STYLE FLY WITH A TUNGSTEN BEAD WORKS FOR ANY STYLE OF NYMPHING YOU FANCY. WITH A SLIM PROFILE THAT COMPLIMENTS A NATURAL MAYFLY, COLORS MIXED WITH SOME FLASH TO MATCH, HAVING THIS FLY IN YOUR BOX IS A WISE DECISION.

SIZES AVAILABLE: 14-18

CODE F PAGE 108- 131

NEW FLIES



GOLDEN

GOLDEN NUGGET
TIED BY SIGNATURE TYER
JOSH GRAFFAM

LIVING IN THE ROCKY MOUNTAINS WE HAVE LOTS OF FREESTONE, CANYON STYLE STREAMS AND RIVERS THAT ARE FULL OF STONEFLIES. THE GOLDEN NUGGET IS A GREAT REPRESENTATION OF BOTH THE SALLY AND SMALLER GOLDEN STONEFLIES THAT CAN BE FISHED YEAR ROUND. WE ALSO HAVE A BLACK VERSION THAT REPRESENTS THE SMALL WINTER STONE THAT WE FIND OUT AND ABOUT ON MANY DRAINAGES. THIS FLY WAS DESIGNED FOR COMPETITIONS, SPECIFICALLY THE WFFC IN VAIL COLORADO BUT FISHES EQUALLY WELL UNDER AN INDICATOR OR AS A DROPPER ON BIGGER DRY FLIES. THIS PATTERN STANDS ON ITS OWN AS A PERDIGON STYLE STONEFLY, GETTING DEEP QUICK AND STAYING AT DEPTH NO MATTER HOW STRONG THE CURRENT.

SIZES AVAILABLE: 12-18 VARIED BY COLOR
CODE G PAGE 108, 131



BLACK



MERCURY SH PHEASANT TAIL
TIED BY SIGNATURE TYER
PAT DORSEY

THE SOFT HACKLE MERCURY PHEASANT TAIL IS A NIFTY LITTLE SOFT HACKLE THAT MIMICS EMERGING MAYFLIES DURING THE HEIGHT OF A HATCH. THE SOFT HACKLE (PARTRIDGE) AND THE FLUFFY PEACOCK HERL THORAX BREATHE LIFE WHILE THE SILVER-LINED GLASS BEAD ADDS A "DASH OF FLASH" THAT HELPS SEPARATE IT FROM THE CROWD. THE "MERCURY BEAD" MIMICS THE HIGHLY REFLECTIVE AREA OF TRAPPED GAS IN THE THORAX DURING EMERGENCE WHICH BECOMES A "TRIGGER" TO NEARBY FISH. THE SOFT HACKLE MERCURY PHEASANT TAIL CAN BE FISHED UNDERNEATH A STRIKE INDICATOR OR PRESENTED DOWN AND ACROSS WITH TRADITIONAL WET-FLY TACTICS. THE SOFT HACKLE MERCURY PHEASANT TAIL IS A NICE ADDITION TO THE MERCURY SERIES.

SIZES AVAILABLE: 14-18
CODE F PAGE 113, 116



PMD

IMMORTAL MAY
TIED BY SIGNATURE TYER
JOSH SMITHERMAN

THE IMMORTAL MAY WAS DESIGNED TO BE AN EXTREMELY DURABLE MAYFLY NYMPH. THE RUBBER TAIL AND LEGS ARE BASICALLY INDESTRUCTIBLE AND THE ABDOMEN IS PRETTY DANG CLOSE. USUALLY THE WIRE RIB IS THE FIRST THING TO GET WORN OUT ON THIS PATTERN, WHICH SHOULD SAY ENOUGH ABOUT THE DURABILITY. THE THORAX IS MADE OF CDC DUBBING TO GIVE EXTRA MOVEMENT AND THE BEAD IS TUNGSTEN TO HELP GET IT DOWN IN THE ZONE. WITH THE UPTURNED EYE ON THE TMC 226BL, THERE IS PLENTY OF HOOK GAP ON EVEN THE SMALLER SIZES. THIS IS A GREAT PATTERN FOR BRINGING FISH TO THE NET AND WHILE KEEPING THE FLY BOX FULL. IT'LL BE DIFFICULT TO FIND A LONGER LASTING MAYFLY PATTERN THAN THIS ONE.

SIZES AVAILABLE: 16-20
CODE DD PAGE 109



BLACK



OLIVE



BROWN

PICKY EATER PERDIGON
TIED BY SIGNATURE TYER
ZACH VANDEHEY

AS AN AVID FLY FISHERMAN, I'VE SPENT COUNTLESS HOURS ON THE DESCHUTES RIVER IN CENTRAL OREGON. IT'S A CHALLENGING RIVER WITH STRONG FLOWS AND DEEP WATERS, BUT IT'S ALSO HOME TO A VARIETY OF NATURAL FOOD SOURCES THAT MAKE IT AN IDEAL SPOT FOR FLY FISHING. WHEN SELECTING FLIES FOR THIS RIVER, I'VE ALWAYS BEEN A FAN OF THE PERDIGON-STYLE FLIES FOR THEIR FAST SINKING ABILITY IN THE RIVER'S SWIFT CURRENTS. HOWEVER, MOST OF THE PATTERNS AVAILABLE ARE TIED WITH FLASHY MATERIALS THAT DON'T QUITE MATCH THE RIVER'S NATURAL OFFERINGS. THAT'S WHEN I DECIDED TO CREATE MY OWN FLY - THE PICKY EATER. THIS FLY FEATURES A SIMPLE BODY DESIGN THAT HELPS IT SINK QUICKLY AND A NATURAL CDC COLLAR THAT GIVES IT A REALISTIC, ORGANIC LOOK. TO MAKE IT EVEN MORE EFFECTIVE, I ADDED A HOT TAG IN A UNIQUE POSITION THAT MIMICS THE WING PAD OF A MAYFLY NYMPH.

SIZES AVAILABLE: 14-18
CODE F PAGE 114, 133



OLIVE



PHOTO: GARRISON DOCTOR

NYMPHS CONTINUED



SPACE X NYMPH
TIED BY SIGNATURE TYER
DEVIN OLSEN

TAG NYMPHS HAVE BECOME A CORE PART OF MY NYMPH SELECTION. SINCE I FIRST STARTED TYING THE BLOWTORCH, ITS SUCCESS HAS MOTIVATED ME TO CONTINUE EXPERIMENTING WITH A LOT OF OTHER VARIATIONS. THROUGH THIS EXPERIMENTATION, SEVERAL COLOR SCHEMES HAVE RISEN TO THE TOP AS CONSISTENT PRODUCERS. THE TROUT LET ME KNOW THEY LIKED THE COMBINATION. ALL THAT WAS LEFT WAS DECIDING ON A NAME. A FEW DAYS LATER, MY SON ASKED ME TO WATCH THE LATEST ROCKET LAUNCH WITH HIM AND THE ROCKET REMINDED ME OF MY LITTLE TAG NYMPH ZIPPING ALONG THROUGH THE RIVER. THE SPACE-X NYMPH WAS BORN.

SIZES AVAILABLE: 12-18
CODE F PAGE 122, 134



SWEETMEAT SALLY
TIED BY SIGNATURE TYER
GARRISON DOCTOR

THE SWEETMEAT SALLY IS AN OFF-SHOOT OF MY SWEETMEAT CADDIS WITH A CDC "WING" THAT GIVES THE FLY GREAT LIFE AND MOVEMENT IN THE WATER. AND ALONG WITH THE JIGGED HOOK ENSURES THE FLY FISHES HOOK POINT UP. LOVE THEM OR HATE THEM, YELLOW SALLIES ARE AN INCREDIBLE HATCH ON MANY RIVERS, SO DO NOT BE CAUGHT WITHOUT SOME IN YOUR BOX. THIS FLY IS ALSO A GREAT ATTRACTOR NYMPH. SO DO NOT BE AFRAID TO TIE ONE ON, YELLOW SALLIES HATCHING OR NOT...

SIZES AVAILABLE: 14, 16
CODE E PAGE 124, 134



TOP SECRET BAETIS
TIED BY SIGNATURE TYER
PAT DORSEY

THE TOP SECRET BAETIS IS A SIMPLE, YET EFFECTIVE IMPOSTER OF A TINY MAYFLY NYMPH. TROUT EAT BAETIS NYMPHS YEAR-ROUND REGARDLESS OF THE CONDITIONS. THE TOP SECRET BAETIS IS ESPECIALLY EFFECTIVE DURING THE SHOULDER SEASONS WHEN TROUT KEY HEAVILY ON MAYFLY NYMPHS PRIOR TO AFTERNOON BLUE-WINGED OLIVE HATCHES. LIKE ITS COUSIN THE TOP SECRET MIDGE, I'M A HUGE BELIEVER IN THE "LESS IS MORE" PHILOSOPHY WHEN IT COMES TO FOOLING TOUGH TROUT. THE TOP SECRET BAETIS HAS A SLIM PROFILE, A HINT OF SEGMENTATION IN THE ABDOMEN, LIFE-LIKE LEGS, AND A DARK WING PAD WHICH IS AN IMPORTANT FEATURE WHEN IMITATING THE MATURE NYMPH.

SIZES AVAILABLE: 16-20
CODE C PAGE 124



NATURAL

TWISTED CRANE
TIED BY SIGNATURE TYER
JOSH SMITHERMAN

A LITTLE SIMPLER ADDITION TO THE TWISTED SERIES WITH JUST THE TWISTED ABDOMEN AND A CDC COLLAR. THE NATURAL COLOR VARIATION IS MADE WITH WHITE SPANFLEX. SINCE SPANFLEX HAS A LITTLE TRANSPARENCY TO IT, TAKING A SHARPIE TO THE THREAD ON THE BOTTOM PART OF THE FLY SHOWS THROUGH THE ABDOMEN AND CREATES A PRETTY UNIQUE LOOK TO THIS FLY. I STARTED WITH ONLY THE NATURAL VERSION, BUT COULDN'T LEAVE OUT A TAN VARIATION OF IT. IT'S SIMPLE, BUT SO EFFECTIVE.

SIZES AVAILABLE: 10-14
CODE DD PAGE 125



TAN



GOLDEN

TWISTED STONE
TIED BY SIGNATURE TYER
JOSH SMITHERMAN

THIS IS PROBABLY MY FAVORITE OF MY TWISTED SERIES. STONEFLIES ARE MY FIRST CHOICE IN NYMPHS TO IMITATE AND I FEEL THAT THIS PATTERN DOES IT FANTASTICALLY WITH A BALANCE OF REALISM AND FUNCTIONALITY. THE TWISTED STONE IS PRIMARILY MADE OF UNI-FLEX WHICH MAKES A VERY DURABLE, SEGMENTED ABDOMEN AND STURDY LEGS. THE CDC THORAX AND COLLAR PROVIDE PLENTY OF MOVEMENT AND LOTS OF BUGGINESS. THIS PATTERN HAS THE WEIGHT TO GET DOWN IN THE WATER COLUMN AND CAN BE BEAT AGAINST THE ROCKS CONFIDENTLY.

SIZES AVAILABLE: 12-16
CODE DD PAGE 125



BLACK BROWN



RED

ZEBRA JIG THIN

THE ZEBRA MIDGE. A TRUE CLASSIC FOR TROUT ANGLERS FAR AND WIDE. HOW COULD SUCH A CLASSIC PATTERN BE IMPROVED UPON YOU MIGHT BE WONDERING? WELL, THERE ISN'T TOO MUCH THAT NEEDS TO BE DONE TO THIS ICONIC FLY, BUT UMPQUA IS EXCITED TO INTRODUCE ITS JIGGED VERSION OF THE FAMED ZEBRA MIDGE. TIED ON THE XC210BL-BN WITH A SLOTTED TUNGSTEN BEAD, THIS VERSION OF THE ZEBRA GIVES ANGLERS A BARBLESS OPTION THAT CAN BE DREDGED ALONG THE BOTTOM WITHOUT WORRY OF DULLING YOUR HOOK. A SUBTLE THREAD HOT SPOT BEHIND THE BEAD COMBINED WITH A SLENDER PROFILE AND COATING OF UV RESIN WILL HELP DELIVER THIS FLY INTO THE STRIKE ZONE QUICKLY AND HELP YOU CATCH THE ATTENTION OF FISH LURKING IN THE DEPTHS.

SIZES AVAILABLE: 16-20
CODE F PAGE 126, 165



BLACK OLIVE POISON TUNG PURPLE RUSTY

NEW FLIES

MIDGES



GRAY

BLINDSIDE MIDGE TIED BY SIGNATURE TYER **JON EASDON**

TROUT LOVE THE ACTION STAGES OF AN INSECT'S LIFE. TROUT IN PARTICULAR ARE DRAWN TO THE EMERGENCE STAGE OF THESE INSECTS. THE BLINDSIDE IS AN EXCELLENT REPRESENTATION OF THE EMERGENT STAGE OF NOT ONLY MIDGES, BUT HAS BEEN VERY EFFECTIVE DURING BWO HATCHES. IT CAN BE FISHED IN ANY NYMPHING METHOD AND IS ALSO A GREAT DROPPER PATTERN FOR HOPPER/ DROPPER RIGS. THIS PATTERN HAS BEEN A CULT CLASSIC AMONGST GUIDES ALL OVER THE WORLD FOR THE LAST 2 DECADES. ITS BECOME ONE OF MY TOP NYMPH PATTERNS THAT I FISH YEAR-ROUND, NO MATTER THE LOCATION.

SIZES AVAILABLE: 18-22
CODE F PAGE 96



BLACK PURPLE



UV BLUE

LED MIDGE TIED BY SIGNATURE TYER **KEVAN DAVIDSON**

THE LED MIDGE WAS CREATED WITH SELECTIVE TROUT IN MIND. WHEN YOU ARE DIALED INTO SIZE AND COLOR, CATCHING MORE TROUT CAN COME DOWN TO FINDING SUBTLE WAYS TO MAKE YOUR FLY EASIER FOR TROUT TO SEE. THE LED MIDGE'S WHITE BALLS CAPTURE LIGHT AND CONTRAST AGAINST ITS DARK BODY, MAKING IT MORE VISIBLE UNDER WATER AND STAND OUT IN ALL OF THE RIGHT WAYS. EMERGING MIDGES AND OTHER SMALL INSECTS HAVE TWO TINY WING CASES THAT BULGE BEFORE HATCHING AND THAT IS WHAT THE TINY WHITE BALLS OF THE LED MIDGE IMITATE.

SIZES AVAILABLE: 16-24
CODE E PAGE 98



CHOCOLATE RED UV CREAM UV FUCHSIA



PAT'S MIDGE TIED BY SIGNATURE TYER **PAT DORSEY**

ADULT MIDGES EMERGE BY PULLING THEMSELVES OUT OF THEIR PUPAL SHUCK AND BREAKING THROUGH THE SURFACE FILM. AS THEY EMERGE, THE ADULT MIDGE APPEARS TO BE TWICE AS LONG AS THE PUPA BECAUSE THE TRAILING SHUCK IS ATTACHED TO THE ADULT'S BODY. CLOSE OBSERVATION OF EMERGENCE LEADS ME TO BELIEVE THAT AS THE ADULT STRUGGLES TO FREE THEMSELVES FROM THE PUPAL SHEATH, TROUT KEY HEAVILY ON THIS PHASE OF DEVELOPMENT. PAT'S MIDGE WAS DESIGNED TO IMITATE THESE MIDGES WITH TRAILING SHUCKS. PAT'S MIDGE IS EQUALLY EFFECTIVE WHEN IT COMES MIMICKING MIDGES THAT NEVER COMPLETE THE EMERGING PROCESS. THESE ILL-FATED MIDGES ARE KNOWN AS CRIPPLES OR STUCK IN THE SHUCK MIDGES.

SIZES AVAILABLE: 18-24
CODE E PAGE 100

SCUDS



GRAY

JIGGY SCUD TIED BY SIGNATURE TYER **MIKE MERCER**

WE HAVE COME TO UNDERSTAND THAT THERE IS A VERY HEALTHY POPULATION OF SCUDS IN OUR HOME RIVER. THEY COME IN ALL SIZES AND COLORS, THOUGH THE MAJORITY SEEM TO BE IN THE #14-#18 SIZE RANGE, WITH COLORS TENDING TOWARDS TANS/GRAYS, ORANGES AND OLIVES. I'VE TIED PATTERNS ACCORDINGLY, AND THE FISH SEEM TO LIKE THEM ALL. BECAUSE THEY HAVE A TUNGSTEN BEAD, THEY PLUMMET QUICKLY, WITH EVEN SMALL VERSIONS GETTING DOWN FAST. I TYPICALLY FISH THEM BENEATH AN INDICATOR, EITHER AS THE BOTTOM FLY BELOW A LARGER PATTERN, OR IN TANDEM WITH A SECOND SCUD OF A DIFFERENT SIZE AND COLOR. BECAUSE OF THE TUNGSTEN BEADS, THEY EVEN WORK WELL FOR EURO-NYMPHING. HOWEVER YOU LIKE TO NYMPH, GIVE THESE A TRY...I AM FINDING THEY WORK WELL EVEN IN STREAMS THAT HAVE NO SCUDS!

SIZES AVAILABLE: 12-18 VARIED BY COLOR
CODE F PAGE 132, 142



OLIVE ORANGE



ORANGE

SLAP SHOT SCUD TIED BY SIGNATURE TYER **JON EASDON**

IN MY BELIEF, ONE OF THE MOST OVERLOOKED FLY PATTERNS FOR TROUT IS THE SCUD. SCUDS ARE AN IDEAL FOOD SOURCE FOR FISH AND ARE READILY AVAILABLE IN MOST STREAMS, RIVERS, AND LAKES. IN YEARS PAST THERE HAVE NOT BEEN A WHOLE LOT OF DIFFERENT SCUD PATTERNS AVAILABLE. THIS WAS THE INSPIRATION TO CREATE A PATTERN THAT EVEN THE PICKIEST FISH WOULD INHALE. THIS PATTERN UTILIZES A TUNGSTEN BEAD AND JIG HOOK THAT RIDES WITH THE HOOK POINT UP. IT'S THE PERFECT BALANCED SCUD PATTERN FOR STRAIGHT LINE NYMPHING AND EURO NYMPHING AND IS ALSO EQUALLY EFFECTIVE IN STILLWATER. THE SLAP SHOT IS AVAILABLE IN A WIDE ARRAY OF SIZES AND COLORS TO COVER ALL OF THE BASES NO MATTER WHERE YOU ARE FISHING IT.

SIZES AVAILABLE: 12-16 VARIED BY COLOR
CODE F PAGE 142



GRAY OLIVE

LAKE FLIES



BLUE

CHUBBY DAMSEL

TIED BY SIGNATURE TYER

LONDON MAYER

TROUT ARE MORE WILLING TO TAKE A LARGE DRY FLY LIKE A DAMSEL WHEN IT SURFS IN AND OUT OF VIEW WITH A BIG FISH CHOP. THEN ONE DAY IT HIT ME—TAKE SOME OF THE FEATURES OF THE BEST FLOATING ATTRACTOR DRIES EVER, THE CHUBBY. WITH A SLIM 2MM FOAM BODY, BLACK SYNTHETIC LEGS LIKE THE ADULT. INSTEAD OF A SECOND PAIR OF LEGS, THE BARED FLAKE SILLY LEGS REPRESENT THE WET WINGS ON THE SURFACE LIKE STABILIZERS ON A CANOE.

THE POLY YARN TUFT IS A GREAT SIGHTER FOR TRACKING THE FLY. WHILE THE EXTENDED DAMSEL BRAID TAIL COMPLETES THE REALISTIC LOOK WITH THE TIP COATED IN RESIN TO PREVENT FRAYING.

SIZES AVAILABLE: 14, 16
CODE I PAGE 146



OLIVE



OLIVE

TWISTED DAMSEL

TIED BY SIGNATURE TYER

JOSH SMITHERMAN

THIS PATTERN HAS BEEN A GREAT CLEARWATER CARP PATTERN FOR ME. HOWEVER, WITH HOW PREVALENT DAMSELS ARE, JUST ABOUT EVERYTHING HAS DAMSEL NYMPHS ON THE MENU. ALTHOUGH STILLWATER WAS MY MAIN THOUGHT BEHIND THE DEVELOPMENT OF THIS, IT'S BEEN A KILLER LITTLE PATTERN IN THE CREEKS.

THIS DAMSEL IS FAIRLY LIGHT IN WEIGHT, WITH BEAD CHAIN EYES BEING THE BIGGEST CONTRIBUTOR. THE TAIL IS MY FAVORITE PART OF THIS PATTERN. THE 3 STRANDS OF DADDY LONG LEGS GIVE THIS PATTERN A REALISTIC SEPARATED TAIL, WHILE THE CDC PUFF BREATHE LIFE INTO IT.

SIZES AVAILABLE: 14, 16
CODE F PAGE 151



BLACK

HOT HEAD MINI LEECH

TIED BY SIGNATURE TYER

LONDON MAYER

LEECHES ARE THE ULTIMATE ATTRACTOR IN ANY TROUT'S DIET! THE ONLY WAY TO TAKE THAT TO THE NEXT LEVEL IS BY ADDING SOMETHING TO THE MIX THAT WILL, IN ADDITION TO GETTING THE TROUT'S ATTENTION, TRIGGER THE FISH TO STRIKE. SO WHAT IS AS PRODUCTIVE TO FISH AS A LEECH? WITHOUT HESITATION, THE FIRST THING THAT COMES TO MIND IS AN EGG. BOTH ARE NON ESCAPING MEALS AND IN MANY INSTANCES A LEECH NATURALLY ATTACHES TO AN EGG MAKING THIS COMBINATION THE ULTIMATE ATTENTION SEEKER, MAYER'S HOT HEAD MINI LEECH.

SIZES AVAILABLE: 14, 16
CODE H PAGE 148



OLIVE



Z NAIL

TIED BY SIGNATURE TYER

ZACHARY TOKACH

YEARS AGO, I WITNESSED TROUT EATING SOMETHING, AND SOON CAME TO REALIZE SNAILS WERE ON THE MENU THAT DAY! AND SADLY, I DIDN'T HAVE AN ANSWER, SO I OBSERVED, AND SAMPLED THAT DAY. I COULD RAMBLE ON A LONG STORY BUT SIMPLY PUT TROUT EAT THEM AND I WANTED A SOLUTION! FISHED AS A POINT OR TRAIL FLY UNDER AN INDICATOR ON STILL OR MOVING WATER.

SIZES AVAILABLE: 12
CODE G PAGE 151



BLACK

LED CHIRONOMID

TIED BY SIGNATURE TYER

KEVAN DAVIDSON

THE LED CHIRONOMID IS AN EXTENSION OF THE LED MIDGE DESIGNED TO BE FISHED IN LAKES. CHIRONOMIDS WIGGLE THEIR WAY UP TO THE SURFACE TO HATCH. THE MICRO-THIN LAMBSKIN TAIL WIGGLES LIKE A NATURAL. THE LED CHIRONOMID'S WHITE BALLS CAPTURE LIGHT AND CONTRAST AGAINST ITS DARK BODY, MAKING IT MORE VISIBLE UNDER WATER AND STAND OUT IN ALL THE RIGHT WAYS. CRUISING TROUT ARE LOOKING FOR EMERGING CHIRONOMIDS, AND SOMETIMES CATCHING MORE TROUT COMES DOWN TO FINDING SUBTLE WAYS TO MAKE YOUR FLY EASIER FOR TROUT TO SEE.

SIZES AVAILABLE: 14, 16
CODE F PAGE 148

NEW FLIES

STREAMERS



GREEN/
YELLOW

AKOBE FLY

TIED BY SIGNATURE TYER

JEFF WHITE

THE AKOBE FLY WAS DESIGNED TO MAXIMIZE MOVEMENT DURING THE PAUSE ON A RETRIEVE. WE LIKE TO PAUSE IT OVER STRUCTURE AND EITHER SHAKE THE ROD TIP OR TAP THE ROD ABOVE THE GRIP TO MAKE THE FLY FLUTTER. THE JOINT AND RUBBER LEGS CREATE A LOT OF MOVEMENT AND THE FARRAR BLEND SHEDS WATER ON THE BACK CAST. INITIALLY DESIGNED AS A TROUT FLY IT WORKS EQUALLY WELL ON BASS.

SIZES AVAILABLE: 6
CODE J*

PAGE 54, 156, 194



BLACK/ RED WHITE/ RED



OLIVE/NATURAL

NINE LB HAMMER

TIED BY SIGNATURE TYER

CHARLIE CRAVEN

THE HAMMER CAME ABOUT AS AN ANSWER TO A COUPLE REQUESTS FROM SOME VERY FISHY BUDDIES. WHEN TWO FISH MAGNETS IN A ROW ASK YOU ABOUT DEVELOPING A PATTERN TO IMITATE A CRAWDAD THAT CAN BE FISHED UNDER AN INDICATOR OR STRIPPED, YOU GET RIGHT TO WORK. WEIGHTED WITH A SLOTTED TUNGSTEN BEAD ON THE INCREDIBLE TIEMCO 708 JIG HOOK, AND FEATURING MULTICOLOR TAILS AND FINE SILI LEGS, THE HAMMER IS RIGHT AT HOME UNDER AN INDICATOR OR A BIG FAT ANGLE DRIFTING THROUGH YOUR FAVORITE RUNS.

SIZES AVAILABLE: 6-10

CODE I PAGE 1054, 160



BLUE/ GRAY CRAW



TAN

BALANCED SCULPIN

TIED BY SIGNATURE TYER

BRIAN SILVEY

THIS FLY WAS BORN ONE THE DESCHUTES RIVER SWINGING FOR THE RESIDENT TROUT THERE. I WANTED TO BEST MIMIC THE GLIDING ACTION OF A SCULPIN AND STARTED TO PLAY WITH FLY DESIGNS THAT WOULD BEST DO THAT. I SETTLED ON A BALANCED STYLE FLY AS IT KEEPS THE FLY RIDING LEVEL AS IT COMES ACROSS THE RUN. I HAVE ALSO FOUND THIS FLY TO BE SUPER EFFECTIVE DEAD DRIFTED OR HUNG IN SLOWER WATERS TOO.

SIZES AVAILABLE: 6

CODE E* PAGE 156



BLACK OLIVE WHITE



OLIVE

POACHER

TIED BY SIGNATURE TYER

LANCE EGAN

THE POACHER IS A DENSE, FAST SINKING STREAMER IDEAL FOR JIGGING ON A EURO RIG, OR STRIPPING BEHIND A LARGER STREAMER TO SEAL THE DEAL ON WARY TROUT. THIS FLY IS ALL MOVEMENT. FROM THE SQUIRREL TAIL, TO THE SIMI SEAL BODY, AND SOFT HACKLE COLLAR, THE POACHER IS A CHAMPION SWIMMER. I'VE HAD GREAT SUCCESS WITH THE POACHER FOR A COUPLE YEARS NOW, AND IT IS OFTEN THE FIRST STREAMER I TIE ON WHEN REACHING FOR A CONFIDENCE PATTERN. AVAILABLE IN BLACK, OR SCULPIN OLIVE. BOTH COLORS ARE PROVEN PRODUCERS.

SIZES AVAILABLE: 8-12

CODE H PAGE 133, 160



BLACK



OLIVE

MOUNTAIN LOBSTER

TIED BY SIGNATURE TYER

JOSH SMITHERMAN

THE MOUNTAIN LOBSTER IS A FLY THAT I DESIGNED IN NOVEMBER OF 2017 WHILE GETTING READY FOR THE SPRING. THE FIRST VERSION WAS A LOT BIGGER AND I STILL FISH IT FOR LARGER BASS A GOOD BIT. HOWEVER, THE NEW, SMALLER VERSION HAS BEEN FAR MORE SUCCESSFUL OVERALL. THE KEY TO THE SUCCESS OF THIS FLY IS THAT IT HAS A GREAT HATCHLING CRAWFISH PROFILE WHILE STILL HAVING PLENTY OF MOVEMENT. I'VE CAUGHT JUST ABOUT EVERYTHING THE TEXAS HILL COUNTRY HAS TO OFFER WITH THIS FLY AND I'VE HAD A LOT OF LUCK WITH IT IN THE ROCKIES AND OZARKS CATCHING TROUT ON IT. THIS IS UNDOUBTEDLY MY GO-TO CREEK FLY WHEN CRAWFISH ARE ABUNDANT.

SIZES AVAILABLE: 8, 12

CODE KK PAGE 55, 158



ORANGE



RAINBOW

SLG MINNOW

TIED BY SIGNATURE TYER

JEFF WHITE

I WAS LOOKING FOR A STREAMER THAT WOULD MIMIC A SLUGGO OR STICKBAIT BUT WITH A LITTLE MORE ACTION FROM THE MATERIAL. CRAFT FUR WAS THE NATURAL CHOICE TO ADD THAT MOVEMENT. THE OTHER KEY IS THE ADDITION OF LEAD WRAPS UNDER THE HEAD. THE COMBINATION OF THE WEIGHTED HEAD AND CRAFT FUR BODY CAUSES THE FLY TO UNULATE WHILE IT DROPS SLOWLY ON PAUSES. A DEADLY COMBINATION. IT ALSO TRANSFERS WELL TO SALTWATER FOR IMITATING CERTAIN BATTLEFISH LIKE SPEARING. THE SLG HAS BEEN THE BEST SELLING STREAMER IN OUR SHOP FOR A DOZEN YEARS.

SIZES AVAILABLE: 01

CODE F* PAGE 160, 196



CHARTREUSE PURPLE WHITE YELLOW

SALT



TAN

BOOBIE CRAB

TIED BY SIGNATURE TYER
LEX HOCHNER

THE SIGNIFICANCE OF NUANCED MATERIAL COLORATION ON SPECIFIC FLY PATTERNS OFTEN GOES UNAPPRECIATED BY BOTH THE CASUAL AND HARD CORE ANGLER. THE FACT THAT A SPECIFIC FLY CATCHES FISH IS SUFFICIENT REASON FOR ITS USE. WHEN DEL BROWN CREATED HIS TRULY REVOLUTIONARY MERKIN CRAB, THE TARGETING OF PERMIT BY SERIOUS ANGLERS WAS CHANGED FOREVER. FINALLY, A WORKABLE REALISTIC CRAB PATTERN WAS BORN AND COUNTLESS VARIATIONS UPON THE ORIGINAL THEME HAVE SINCE BEEN CREATED. AS WITH ITS PREDECESSORS, THE "BOOBIE CRAB" FEATURES AN UP-ANGLED TAIL THAT ENSURES VERTICAL DESCENT AND STRAIGHT TRACKING, AND A BODY CONSTRUCTED WITH CASCADE CREST TOOLS VARIEGATED BODY FUR, A SUPERB MATERIAL THAT MIMICS THE MOTTLED COLORATION OF NATURALS.

SIZES AVAILABLE: 01
CODE I* PAGE 174



AMBER OLIVE



BLACK

CHEWY'S FIT FOR A KING

TIED BY SIGNATURE TYER
DAVE CHOUINARD

HAVING FLY OPTIONS FOR TARPON IS VERY IMPORTANT AS THEIR FEEDING HABITS AND MOODS CAN CHANGE BY THE HOUR. POON CAN BE AFFECTED BY CRAB FLUSHES, DIRTY WATER, MOON PHASES AND MORE, SO HAVING DIFFERENT SILHOUETTE AND ACTION FLIES CAN MAKE ALL THE DIFFERENCE TO GET THE BITE. CHEWY'S "FIT FOR A KING" TAKES THE SEDUCTIVE ACTION OF A SPLAYED HACKLE TARPON FLY, WITH A GREAT SILHOUETTE AND ACTION THAT ONLY ARCTIC FOX CAN PROVIDE. THIS IS A GOOD CHOICE FOR ANY SILVER KING ANGLER FOR MORNINGS, EVENINGS, BACKCOUNTRY OR FOR TIDES WITH SOME CRAB FLUSHES.

SIZES AVAILABLE: 2/0
CODE I* PAGE 188



OLIVE TAN



CHARTREUSE/
WHITE

CHEWY'S BENDER

TIED BY SIGNATURE TYER
DAVE CHOUINARD

THE BENDBACK FLY HAS BEEN PROVEN AS ONE OF THE MOST WEEDLESS AND SNAG FREE FLY PATTERNS OF ALL TIME. SOME OF THE BEST FISHING HAPPENS AROUND SNAGS, ROCKS AND VEGETATION AND GETTING YOUR FLY SNAGGED UP AT THE WORST MOMENT IS PAINFUL. UNLIKE OTHER PATTERNS THAT RELY ON MONO WEED GUARDS, CHEWY'S BENDER IS NATURALLY SNAG FREE BY DESIGN. CHEWY'S BENDER ALSO IMPROVED THE SWIMMING AND BALANCE OF THE ORIGINAL BENDBACK BY USING UMPQUA'S TUNGSTEN JIG BOMBS AND XS435 HOOK. CHEWY'S BENDER IS THE SOFTEST LANDING, BEST FISHING WEEDLESS FLY FOR A MULTITUDE OF SPECIES AND DEPTHS.

SIZES AVAILABLE: 01, 02 WEIGHTED & UNWEIGHTED
CODE I* PAGE 174



BLACK OLIVE/TAN WHITE



OLIVE

CHEWY'S TARPONATOR

TIED BY SIGNATURE TYER
DAVE CHOUINARD

THE TARPONATOR MAY BE ONE OF THE MOST PRODUCTIVE TARPON FLIES YOU WILL EVER CAST. DEVELOPED ON THE WEST COAST OF FLORIDA, ON SOME OF THE MOST PRESSURED MIGRATORY FISH, IT HAS PROVEN ITSELF TO BE YOUR "GO TO" PATTERN. THE SLIMY, WIGGLY ACTION WILL IMMEDIATELY GET YOUR ATTENTION. IT IS EASY TO CAST, DOESN'T FOUL AND HAS LOW BULK TO ENSURE GREAT HOOK-UPS. THIS PROVEN SILHOUETTE AND ACTION JUSTIFIES HAVING IT IN MULTIPLE COLORS.

SIZES AVAILABLE: 2/0
CODE K* PAGE 188



BLACK/PURPLE PINK/TAN



HONEY

CHEWY'S CHEWCEIVER

TIED BY SIGNATURE TYER
DAVE CHOUINARD

THE CHEWCEIVER WAS INSPIRED BY LEFTY'S DECEIVER TO SOLVE THE RIDDLE OF PRESENTING A SMALLER BAITFISH PATTERN THAT WILL LAND SOFT, HAVE ACTION AND FOOL THE PICKIEST FISH. WITH ITS NATURAL HEN HACKLE AND FOX, THIS SPARSE AND LIFELIKE BAITFISH PATTERN CAN BE BLIND FISHED OR SIGHT CASTED IN CLEAR WATER. A MUST HAVE FOR ALL FLY BOXES AND CAN CATCH ANYTHING FROM LARGE MOUTH BASS TO FALSE ALBACORE OR SNOOK. GREAT FOR FLY SHOPS TO HELP OUTFIT ANGLERS TRAVELING TO MULTIPLE DESTINATIONS.

SIZES AVAILABLE: 04-08
CODE 6* PAGE 168



WHITE



BROWN

MAGNUM MANTIS

TIED BY SIGNATURE TYER
DREW CHICONE

I CHOSE THE UMPQUA XS 435 BENDBACK HOOK FOR THE FOUNDATION OF THE FLY. IT'S AN EXTREMELY STRONG FORGED HOOK WITH A UNIQUE SHAPE. NOT ONLY DOES THE BEND OF THE HOOK PERFECTLY EMULATE THE CURVATURE OF A MANTIS SHRIMP, BUT IT IS VERY WELL SUITED FOR PATTERNS DESIGNED TO RIDE IN THE HOOK POINT-UP POSITION. THIS IS CRITICAL WHEN FISHING AROUND HARD-BOTTOM HABITATS LIKE CORAL RUBBLE OR OYSTERS, WHERE GETTING HUNG UP IS A FREQUENT OCCURRENCE. A SHORT STRIP WITH A PREGNANT PAUSE IS TREMENDOUSLY EFFECTIVE. WHEN WADING THE FLATS, LOOK DOWN AT THE TINY HOLES THREE TO FOUR INCHES APART IN THE MUD. THE DISTANCE BETWEEN THE HOLES IS A GOOD GAUGE OF HOW LONG YOUR STRIPS SHOULD BE. A REAL SHRIMP TRYING TO TAKE COVER IS DASHING ONLY FROM ONE HOLE TO THE NEXT. YOUR FLY SHOULD EFFECTIVELY MIMIC THESE TINY, ABRUPT MOVEMENTS

SIZES AVAILABLE: 01
CODE J* PAGE 177



CHARTREUSE ORANGE TAN

NEW FLIES



GHOST

MAYHEM MOLE CRAB

TIED BY SIGNATURE TYER
DREW CHICONE

WHEN IMITATING THESE BIZARRE BOTTOM DWELLERS, THERE ARE SEVERAL FACTORS YOU NEED TO TAKE INTO CONSIDERATION. MOLE CRABS, OR SAND FLEAS, AS THEY ARE COMMONLY CALLED, SPEND MOST OF THEIR TIME HIDDEN FROM PREDATORS, SLIGHTLY UNDER THE SAND. AS THE TIDE FALLS, THE TINY CRABS EMERGE INTO THE SURF AND ARE CARRIED IN THE WAVES TO THEIR NEXT RESTING SPOT. WITHIN A MATTER OF SECONDS, THE MOLE CRABS CAN BURY THEMSELVES BY BACKING INTO THE SOFT SAND TO HIDE. FOR THIS REASON, MY MAYHEM MOLE CRAB PATTERN HAS TWO MONOFILAMENT KEELS WEIGHTED HEAVILY WITH TUNGSTEN BEADS. THIS HELPS GET THE FLY DOWN TO THE SAND QUICKLY. THE ADDED WEIGHT ALSO AIDS IN CREATING A DISTURBANCE IN THE SAND WHEN THE FLY IS STRIPPED. THIS PUFF OF SAND IS CRUCIAL WHEN IMITATING THE CRAB'S DEFENSE MECHANISM OF BURYING ITSELF IN THE SAND.

SIZES AVAILABLE: 02
CODE K* PAGE 177



OLIVE TAN



RED/ OLIVE

PEYOTE PALOLO

TIED BY SIGNATURE TYER
DREW CHICONE

LIKE ALL MY PATTERNS, THE PEYOTE PALOLO WAS DESIGNED WITH MORE THAN JUST LOOKS IN MIND. THE MOST IMPORTANT ELEMENT TO ALL FLIES IS THE HOOK. I PREFER A SHORT SHANK HEAVY WIRE HOOK FOR TARPON FOR SEVERAL REASONS. FIRST, THE HOOK HAS TO BE HARDY ENOUGH TO HOLD UP TO THE ABUSE THAT THESE HEAVYWEIGHTS CAN DOLE OUT, BUT ALSO, THE SHORT SHANK REDUCES THE LEVERAGE THE FISH HAS FOR SHAKING THE HOOK FREE DURING BATTLE. I EXPERIMENTED WITH SYNTHETICS, RUBBER BANDS, AND ZONKER STRIPS, AND ALTHOUGH THEY HAD FANTASTIC MOVEMENT, THEY FOULED EASILY, AND I JUST WASN'T HAPPY WITH WHERE THE FLY RODE IN THE WATER COLUMN. ENSURING THAT THE FLY WOULD TRACK JUST UNDERNEATH THE SURFACE WAS PARAMOUNT TO ITS SUCCESS.

SIZES AVAILABLE: 3/0, 1/0
CODE D* PAGE 188



POP'S SHAD HD

TIED BY SIGNATURE TYER
DANIEL ROBERTS

THE BEEFED-UP VERSION OF MY ORIGINAL POP'S SHAD. THE FLY NOW SITS ON A SUPER STRONG XS415H HOOK IN 1/0 AND 3/0 READY TO TACKLE THE BIGGEST FISH YOU CAN TARGET. SOME ADDITIONAL NEW FEATURES INCLUDE GLOW IN THE DARK MOLDED EYES AND UPDATED BODY MATERIAL FOR ADDED DURABILITY AND COLOR CONTRAST. THIS PATTERN IS PERFECT FOR YOUR LOCAL LAKES AND RIVERS HOLDING THREADFIN SHAD 2-4" LONG TO ENTICE STRIPERS, BASS, WHITE BASS, WALLEYE AND MORE. THE SUBTLE FLASH THROUGHOUT THE BODY SHIMMERS IN THE LIGHT AND ITS NEUTRAL BUOYANCY HELPS IT SINK FLAT, GIVING IT A NATURAL FALL THROUGH THE WATER COLUMN JUST LIKE A DYING SHAD.

SIZES AVAILABLE: 3/0, 1/0
CODE E* PAGE 184



TAN/ ORANGE

PUNISHER

TIED BY SIGNATURE TYER
DREW CHICONE

THERE'S NOT A WHOLE LOT OF BACKSTORY ON THESE LITTLE GUYS. A WHILE BACK, I POSTED A PICTURE OF THIS SPARSELY TIED PATTERN I PUT TOGETHER ON INSTAGRAM. IT'S PROBABLY ONE OF THE EASIEST PATTERNS AND QUICKEST TO TIE YOU WILL EVER COME ACROSS. I DIDN'T HAVE A NAME FOR IT, SO I LEFT IT UP TO MY READERS TO COME UP WITH A GOOD HANDLE FOR IT IN EXCHANGE FOR A HALF-DOZEN TO THE WINNER. THERE WERE ALL KINDS OF GREAT ENTRIES, BUT THE NAME I LIKED BEST WAS THE PEPPERMINT PUNISHER.

SIZES AVAILABLE: 2/0
CODE F* PAGE 188



BLURPLE CHART/ WHITE KEY LIME PINK/ WHITE



TAN

REDFISH SCAMPI BC

TIED BY SIGNATURE TYER
HENRY COWEN

THE REDFISH SCAMPI WAS DEVELOPED OFF OF UMPQUA'S WIDELY POPULAR BONEFISH SCAMPI PLATFORM WHICH IS ARGUABLY ONE OF THE BEST BONEFISH FLIES TO EVER HIT THE FLATS. THE COLOR PATTERN AND HOOK SIZES WERE TWEAKED TO BETTER FOOL A REDFISH THROUGHOUT THE ENTIRE SOUTHEASTERN UNITED STATES (INCLUDING THE GULF STATES OF TX, LA, MS AND AL). THE ORIGINAL REDFISH SCAMPI WAS ONLY OFFERED WITH WEIGHTED DUMBBELL EYES AND ANGLERS ASKED, "CAN WE GET IT WITH BEAD CHAIN EYES FOR THOSE SUPER SHALLOW BELLY CRAWLERS?" IT WILL NOT ONLY CATCH REDFISH BUT NEARLY ANY FISH THAT SWIMS ON THE FLATS. TO ITS CREDIT IT HAS ALREADY CAUGHT JUVENILE TARPON, SMALL SHARKS, POMPANO, TROUT, FLOUNDER AND SHEEPSHEAD.

SIZES AVAILABLE: 1, 4
CODE H PAGE 178



RUST



TAN

SIMPLE CRAB

TIED BY SIGNATURE TYER
MICHAEL MCGOVNEY

SO I'VE SPENT A LOT OF TIME CHASING LARGE BONEFISH IN VERY SHALLOW WATER. SUPER SPOOKY AND VERY PICKY FISH. STANDARD BONEFISH FLIES JUST DON'T DO THE TRICK. THESE FISH HAVE PHD'S IN FLIES AND WILL LAUGH AT YOU WHILE STILL FEEDING A FOOT FROM YOUR FLY. STUDYING THE FLATS WE WERE ON I NOTICED LOTS OF CRABS SO NEXT STEP WAS TO TRY THE TYPICAL PERMIT CRAB BUT THE PROBLEM WITH THOSE WE FOUND OUT VERY QUICKLY IS THEY ARE LIKE THROWING ROCKS AT THEM. EVERY CAST THE FLY WOULD HIT THE WATER AND SPOOK EVERY FISH WITHIN 20 FEET OF IT. SO I WENT BACK TO THE VISE AND DUG THRU MATERIALS UNTIL I CAME UP WITH THE SIMPLE CRAB. IT LANDS SOFT, HOOK UP AND WHEN WET LOOKS JUST LIKE A REAL CRAB. THE MATERIAL EVEN HOLDS SOME AIR BUBBLES.

SIZES AVAILABLE: 4, 8
CODE F* PAGE 178



LIGHT OLIVE OLIVE BROWN

NEW FLY EXTENSIONS

NEW COLOR



OLIVE

BREADCRUST JIG
TIED BY SIGNATURE TYER
PAT DORSEY

NEW COLOR



FEMALE

CHUBBY TRICO SPINNER

NEW COLOR & SIZES



PEACOCK

CORN-FED CADDIS
TIED BY SIGNATURE TYER
LANCE EGAN

UPDATED DESIGN



CORN-FED SALLY
TIED BY SIGNATURE TYER
LANCE EGAN

NEW COLOR



SPRUCE

ELK CADDIS

UPDATED DESIGN



YELLOW

FLASHTAIL MINNOW
TIED BY SIGNATURE TYER
DAN BLANTON



BLUE

PINK

NEW SIZES



BLACK

THREAD FRENCHIE
TIED BY SIGNATURE TYER
LANCE EGAN

NEW COLORS



MILLER

PINT CADDIS
TIED BY SIGNATURE TYER
JOSH SMITHERMAN

NEW COLOR



TAN

PINT HOPPER
TIED BY SIGNATURE TYER
JOSH SMITHERMAN



OLIVE

NEW COLORS



BLACK

NO MERCY MIDGE
TIED BY SIGNATURE TYER
PHIL IWANE



CREAM

NEW COLOR



LIME

SWEETMEAT CADDIS DEEP
TIED BY SIGNATURE TYER
GARRISON DOCTOR

NEW SIZES



RAINBOW

TAILWATER SOWBUG
TIED BY SIGNATURE TYER
LANCE EGAN

NEW SIZES



RAINBOW

TUNGSTEN TAILWATER SOWBUG
TIED BY SIGNATURE TYER
LANCE EGAN



RIVER GRIP PRECISION SERIES

Introducing the new River Grip Precision Series. This collection of 16 streamside fly fishing tools offers a perfect balance of comfort and precision. With dual-layered, rubberized handles, surgical-grade Japanese stainless steel construction, and features like tapered jaws and ergonomic design, these tools provide enhanced functionality and control. Elevate your fly fishing experience with the River Grip Precision Series, where comfort meets accuracy.



ERGONOMIC FEATURES

- ERGONOMIC EXTENSIONS FOR COMFORT AND PRECISION
- COMFORTABLE DUAL-LAYERED HANDLES
- THOUGHTFUL DESIGN ELEMENTS CREATE A PERFECT BALANCE OF ERGONOMICS AND FUNCTIONALITY

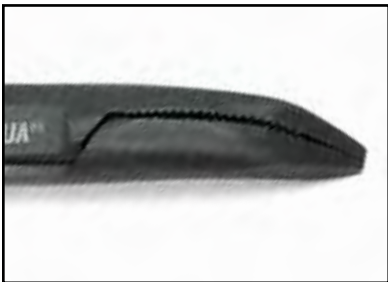

PRECISION TIP

- PRECISION TIP FOR ACCURACY ON THE WATER
- MOST HEMOS AVAILABLE IN STRAIGHT OR CURVED
- SURGICAL-GRADE JAPANESE STAINLESS-STEEL CONSTRUCTION



NEW COLORWAYS

- BLACK/RED
- RED/GRAY
- ORANGE/LT GRAY



IMPROVED NIPPERS

- ERGONOMIC REAR RIDGE TO POSITION YOUR THUMB ON TOP OF THE CUTTING AREA
- SURGICAL-GRADE JAPANESE STAINLESS-STEEL CONSTRUCTION WITH PORTING TO REDUCE WEIGHT

NEW TOOLS

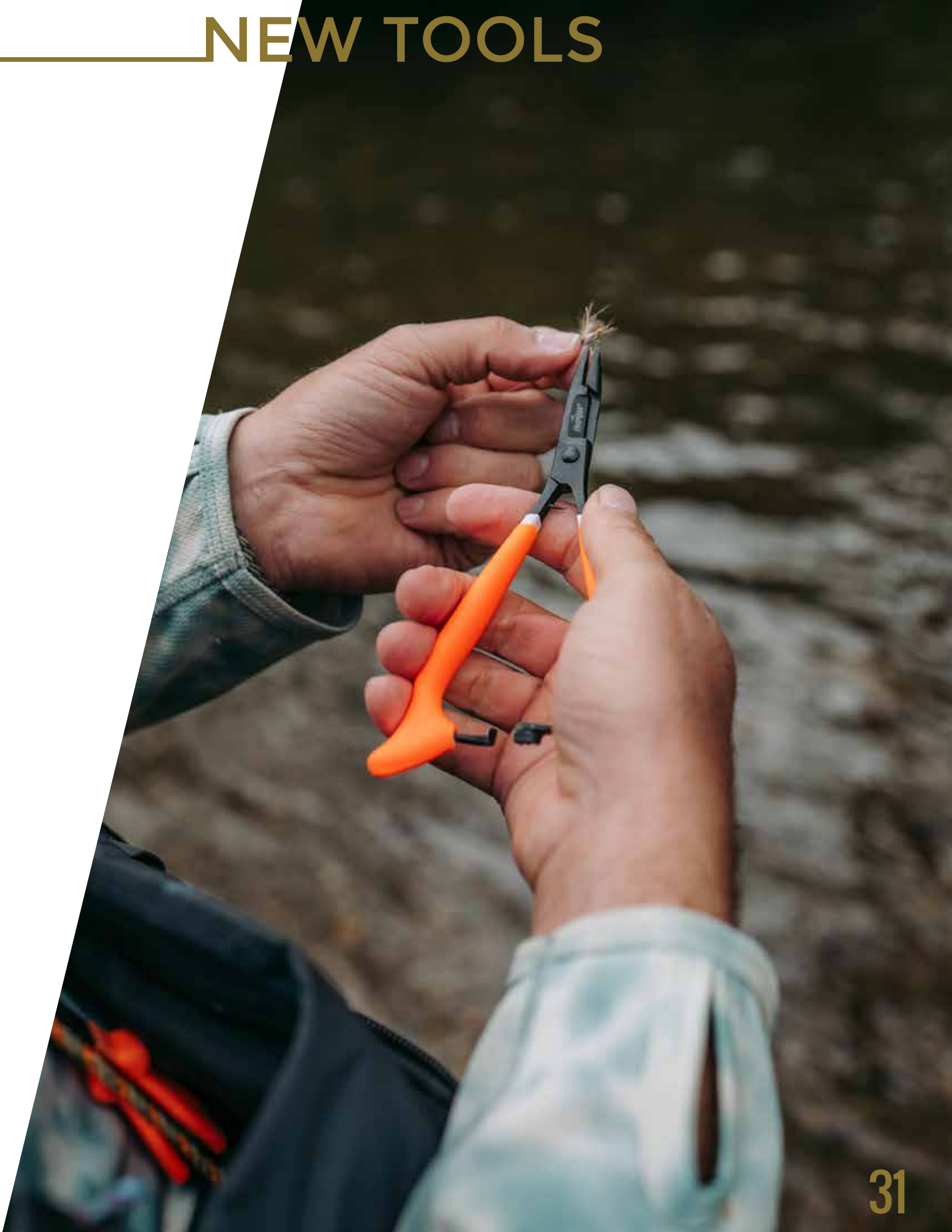

**RIVER GRIP™ PS
6" SCISSOR CLAMP**



STRAIGHT 3 COLORS \$10.99 EACH

**RIVER GRIP™ PS
6" SCISSOR CLAMP**



CURVED 3 COLORS \$10.99 EACH

**RIVER GRIP™ PS
6" SCISSOR CLAMP
OPEN**



STRAIGHT 3 COLORS \$10.99 EACH

**RIVER GRIP™ PS
5" SCISSOR CLAMP**



CURVED 3 COLORS \$7.69 EACH

**RIVER GRIP™ PS
5" SCISSOR CLAMP**



STRAIGHT 3 COLORS \$7.69 EACH

**RIVER GRIP™ PS
5" DEBARB PLIERS**



STRAIGHT 2 COLORS \$7.14 EACH

**RIVER GRIP™ PS
5.5" ULTRA
MITTEN CLAMP**



3 COLORS \$13.74 EACH

**RIVER GRIP™ PS
4" CUT-ALL
BENCH TOOL**



2 COLORS \$5.44 EACH

RIVER GRIP PRECISION SERIES

SEE THE COLLECTION ON PAGE 286

RIVER GRIP™ PS
ZINGER/CLAMP/
NIPPER KIT



3 COLORS \$15.94 EACH

RIVER GRIP™ PS
ZINGER/NIPPER
COMBO



3 COLORS \$8.24 EACH

RIVER GRIP™ PS
NIPPER



3 COLORS \$4.39 EACH

RIVER GRIP™ NIP PS
TUNGSTEN CARBIDE



3 COLORS \$7.14 EACH

RIVER GRIP™ PS
BIG NIP



3 COLORS \$7.14 EACH

RIVER GRIP™ PS
BIG NIP TC
TUNGSTEN CARBIDE



3 COLORS \$10.99 EACH

RIVER GRIP™ PS
NIP & LANYARD



HOT ORANGE & BLACK \$7.69 EACH

RIVER GRIP™ PS
BIG NIP & LANYARD



HOT ORANGE & BLACK \$10.99 EACH

RIVER GRIP™ PS
LANYARD



BLACK \$3.29 EACH

LEADER & TIPPET EURO COLLECTION

Umpqua presents its latest innovations tailored for Euro-nymphing enthusiasts, featuring a range of new leaders and accompanying accessories. These cutting-edge products are designed to elevate your fishing experience with improved strike detection and enhanced visibility. Upgrade your Euro-nymphing setup with these exceptional offerings.



PERFORM X EGAN'S EURO LEADER

\$8.24 EACH

Developed in collaboration with Lance Egan, this specialized leader optimizes modern euro-nymphing techniques, delivering superior performance and strike detection across various skill levels and fly sizes.

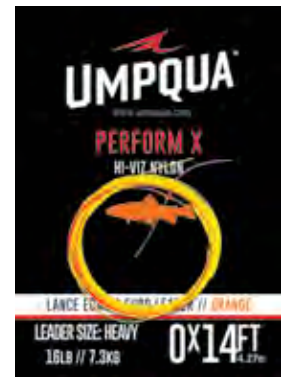

PERFORM X HI-VIZ BUTT MATERIAL

\$10.99 EACH

Construct custom euro leaders using this high-visibility nylon, available in a variety of colors and diameters. It provides excellent visibility, allowing for precise control in euro-nymphing setups.



PERFORM X SIGHTER TIPPET

\$8.24 EACH

Experience exceptional visibility with the bi or tri colored nylon, featuring extremely opaque sharp transitions. Perfect for tracking drifts in both high and low contrast lighting conditions, it enhances your ability to detect subtle strikes.



UMPQUA™ TIPPET RINGS STD 10-PACK

\$4.12 EACH

Simplify adjustments and replacements in your euro-nymphing setup with these small, smooth 2mm rings. Effortlessly connect varying tippet diameters, ensuring seamless transitions and ease of use.



SEE THE COLLECTION ON PAGE 216

THINK PINK

Introducing the revolutionary deceiver hd Pink Fluorocarbon tippet, designed to provide unmatched sub-surface invisibility. As the first color to vanish underwater, its pink hue ensures an ultra-stealthy presentation. The unique pink additive not only enhances knot performance by softening the material, but it also conceals any potential abrasions that may occur while fishing tight to structure where the big ones live.

DECEIVER HD PINK BIG GAME FLUORO TIPPET



DECEIVER HD FLUORO PINK SHOCK TIPPET



YARDS	SIZE	COST
25yd	8lb-40lb	\$8.24-13.74

YARDS	SIZE	COST
25yd	40lb-80lb	\$16.49-24.74

SEE THE COLLECTION ON PAGE 232

WARNING:
Cancer and
Reproductive Harm
www.P65Warnings.ca.gov

- PINK IS THE FIRST COLOR THAT DISAPPEARS UNDERWATER, ADDING TO INVISIBILITY OF FLUOROCARBON
- PINK ADDITIVE MAKES FLURO MORE SUPPLE FOR BETTER KNOTS, FEEL, MEMORY REDUCTION, AND PRESENTATION – CREATING PERFECT HARMONY
- ABRASION DAMAGE VISUAL REDUCTION DUE TO PINK ADDITIVE ADDING TO INVISIBILITY
- PINK OFFERS A VISUAL INDICATOR FOR PRESENTATION PORTION OF YOUR LEADER
- FOR ANGLERS LOOKING FOR THE EXTRA ADVANTAGE IN HIGH STAKES FISHING



FLY BOXES

Umpqua is excited to announce the launch of the continued Evolution of Fly Storage, the all new UPG Fly Boxes.

These new boxes have been designed to provide anglers with storage solutions that are both highly organized and incredibly convenient. Whether you're a dry fly enthusiast, a streamer junkie, or a nymphing aficionado, the UPG Fly Boxes have you covered. We provide you with the best fly storage options on the market so you can focus on what really matters - catching more fish.

No one knows fly storage better than Umpqua.

NEW UPG





Material

FOAM

- Power Grip Foam - Improved holding
- Quick loading
- 25% Lighter than Silicone

SILICONE

- Supreme Grip Silicone / Flies stay where you put them
- Zero memory self-healing silicone
- Long lasting durability

Protection



- IPX 6.5 Waterproof
- Secure Latch Closure
- Magnetic Swing Leaves



- Lightweight/Low Profile
- Ultra-Slim
- Quick Access

Size

COMPACT



- Pocket sized
- Upwards of 120 flies

LARGE



- Serious fly storage
- Upwards of 275 flies

Fly Style

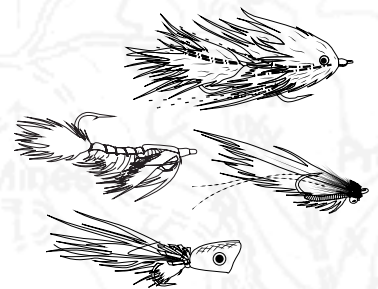
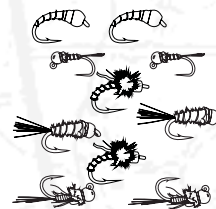
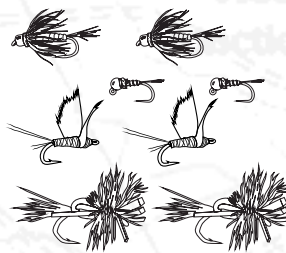
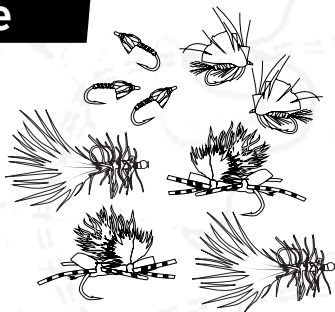

Insert

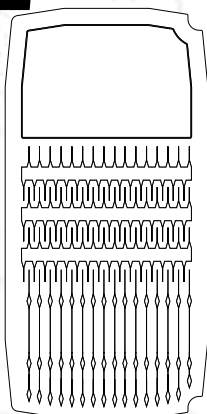

Hybrid

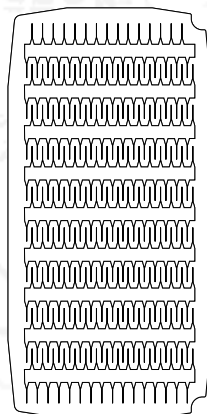

Essential

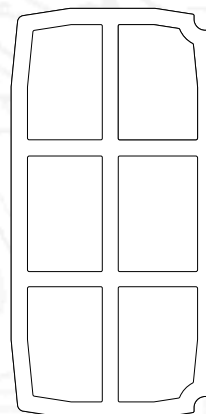

Magnetic

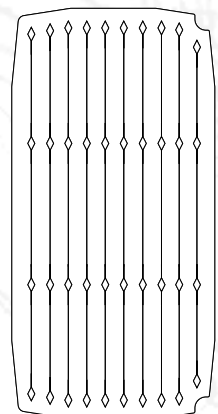

Slit

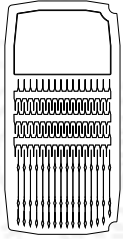

Hybrid Insert

Most Diverse Storage

- Ideal for a wide variety of flies sz 8-26
- Unique storage areas for different flies
- Magnetic Fly Dock - for small flies and drying or staging flies
- Micro Slit - for compact organization of small flies sz 16-20
- Fly Trap – for offset head to tail storage of flies sz 8-16

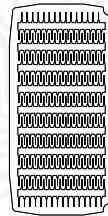

Essential Insert

Everyday Workhorse

- Most compact and user-friendly storage for flies 8-22
- FlyTrap for offset storage without head/tail overlap
- Angled entry points for easy load of flies
- Maximizes capacity and organization
- Deep gutters to protect and preserve fully hackled flies

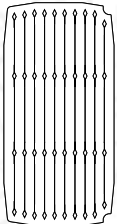

Slit Insert

Big Fly Storage

- Deep foam for secure hold of large hooks sz 1/0-10
- Mega Slit Foam for flies with multiple hooks
- High overhead storage for large flies
- Multiple entry points for maximum capacity and organization

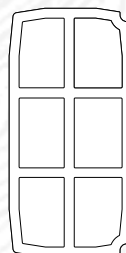
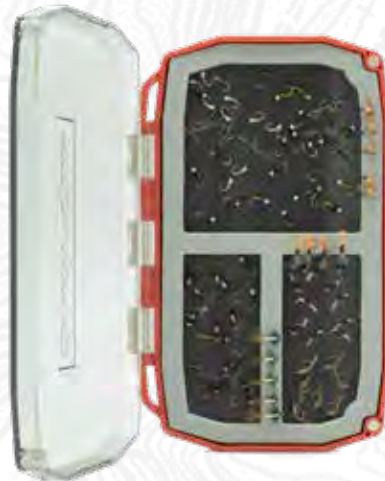

Magnetic Insert

Fast small fly storage

- Best way to organize small nymphs and dries
- Small flies sz16-26
- Fast fly storage
- Deep foam dividers ensure sufficient headroom for dry fly storage

FOAM COLLECTION



OLIVE

WEEKENDER MINI

COST - 16.49 30070



RED

DAYTRIPPER MINI

COST - 13.74 30053



GRAY

DUAL ESSENTIAL MINI

COST - 16.49 30089



GRAY

ESSENTIAL MINI

COST - 10.99 30056



HOT ORANGE

ESSENTIAL MINI

COST - 10.99 30058



RED

MAGNETO MINI

COST - 13.74 30066



OLIVE

WEEKENDER

COST - 19.24 30069



RED

DAYTRIPPER

COST - 16.49 30052



GRAY

DUAL ESSENTIAL

COST - 19.24 30088



GRAY

ESSENTIAL

COST - 13.74 30055



HOT ORANGE

ESSENTIAL

COST - 13.74 30057



RED

MAGNETO

COST - 16.49 30065



AQUA

BAITFISH

COST - 13.74 30051



AQUA

FLATS

COST - 13.74 30063



OLIVE

STREAMER

COST - 16.49 30067



RED

WP DAYTRIPPER MEDIUM

COST - 19.24 30054



GRAY

WP ESSENTIAL MEDIUM

COST - 19.24 30060



AQUA

WP FLATS

COST - 19.24 30064



HOT ORANGE

WP ESSENTIAL MEDIUM

COST - 19.24 30062



HOT ORANGE

WP ESSENTIAL

COST - 21.99 30061



OLIVE

WP WALKABOUT

COST - 30.24 30068



OLIVE

WP WEEKENDER

COST - 24.74 30071



GRAY

WP ESSENTIAL

COST - 21.99 30059

SILICONE



CLARET

WEEKENDER MINI

COST - 16.49 30086



LIME

DAYTRIPPER MINI

COST - 13.74 30073



BLUE

DUAL ESSENTIAL MINI

COST - 16.49 30091



BLUE

ESSENTIAL MINI

COST - 10.99 30076



HOT GREEN

ESSENTIAL MINI

COST - 10.99 30078



LIME

STREAMER

COST - 16.49 30083



CLARET

WEEKENDER

COST - 19.24 30085



LIME

DAYTRIPPER

COST - 16.49 30072



BLUE

DUAL ESSENTIAL

COST - 19.24 30090



BLUE

ESSENTIAL

COST - 13.74 30075



HOT GREEN

ESSENTIAL

COST - 13.74 30077



LIME

WP DAYTRIPPER MEDIUM

COST - 19.24 30074



BLUE

WP ESSENTIAL MEDIUM

COST - 19.24 30080



HOT GREEN

WP ESSENTIAL MEDIUM

COST - 19.24 30082



BLUE

WP ESSENTIAL

COST - 21.99 30079



HOT GREEN

WP ESSENTIAL

COST - 21.99 30081



CLARET

WP WALKABOUT

COST - 30.24 30084



CLARET

WP WEEKENDER

COST - 24.74 30087

SEE THE COLLECTION ON PAGE 256

NEW X-SERIES HOOKS

Umpqua's innovative collection X-Series hooks continues to bring to market hooks that are in sync with current trends in fly tying. The X-Series hooks fill a niche in the market and are purpose built. The new collection of five models of dry fly hook are no different. All produced with Japanese Steel.



XC110



A barbless, down eye hook with a wide gape, the XC110 is a perfect all-around hook for many different straight-bodied dry fly and nymph patterns.

\$5.23 25PACK
JAPANESE STEEL



XC120



A barbless, down eye hook with an extra wide gape and upturned point, the XC120 is a perfect all-around hook for many different straight-bodied dry fly and nymph patterns.

\$5.23 25PACK
JAPANESE STEEL



XC130



A barbless, down eye hook with a wide gape and upturned point, the XC130 is a perfect all-around hook for many different straight, long-bodied dry fly and nymph patterns.

\$5.23 25PACK
JAPANESE STEEL



XC220



The XC220 hooks offer tyers a short, straight shank barbless hook, with a straight eye, and an extra wide gape to suit a mix of extended body dries & emergers and general nymphs. The X-wide gape allows for oversized beads and high hook-up rates.

\$5.23 25PACK
JAPANESE STEEL

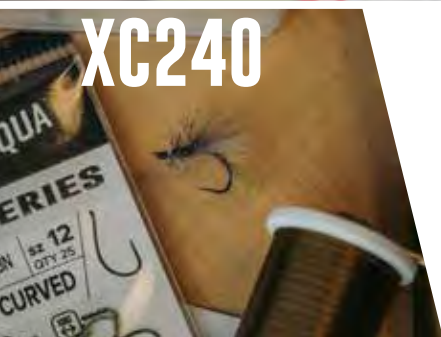

XC240



The curved shank and upturned eye of the XC240 gives tyers a unique option for stonefly, caddis, shrimp, emergers, and many other styles of flies.

\$5.23 25PACK
JAPANESE STEEL

WARNING:
Cancer and
Reproductive Harm
www.P65Warnings.ca.gov

NEW TOOLS

TYING TOOLS AND KITS



NEW TMC EVO BOBBINS

The simplest and easiest operation available in a premium bobbin. After decades as the first and best ceramic bobbins on the market, Tiemco has applied improved designs and materials to make a great bobbin even better. The EVO has more rigid arms and upgraded hubs that reduce start-up inertia and enhance smooth rotation. These new features, combined with the highest grade ceramic tubes on the market result in less thread breakage.

The first and best ceramic bobbins on the market are now even better.

NEW 5-PIECE TYING TOOL KIT

All of your essential tying tools in one great travel case. Includes the following Dream Stream + tools: standard bobbin, bodkin, whip-finish tool, hackle plier, and 3.5" arrow point scissor. Everything you need including a carry case! Now all of our Dreamstream+ tool kits come in a new TAN color too.



DREAM STREAM™ PLUS HD BOBBIN
NEW TAN COLOR



NEW MERCHANDISE

SEE THE REST OF THE COLLECTION ON PAGE 294

THUNDER THIGHS ROPE HAT



Semi-Structured, Low Profile, throw-back rope cap. Stick to the classics with a tried and true pattern and cap.

DRY FLY EMBROIDERY CAP



Unstructured, Low Profile, - Rep the classics, and catch some big fish on Dries this year

RETRO FLY PATCH CAP



New Richardson 112 with a classic wet fly patch.

UMPQUA STREAMER COWBOY SHIRT

UNISEX T-SHIRT



NEW UMPQUA STICKER 6-PACK



Another set of six stickers to share your love of life on the water.
To be sold together or individually.



**STICKERS NOW AVAILABLE AS
PACKS OF TEN**

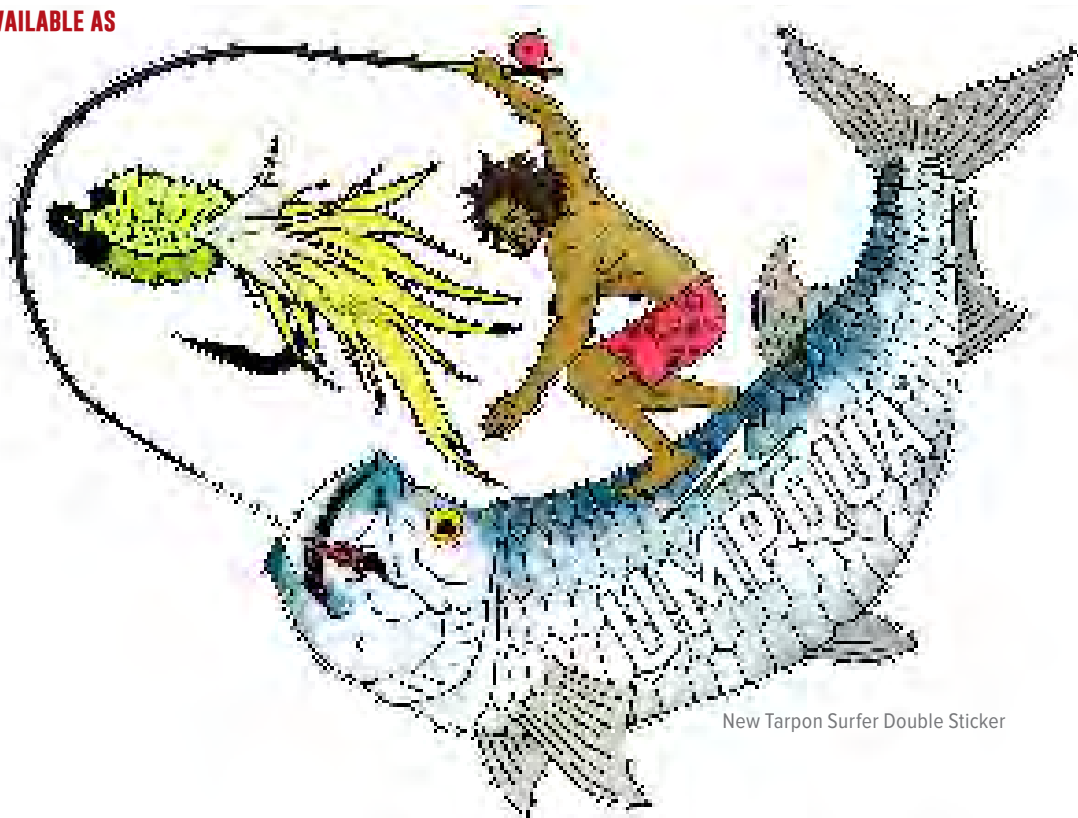

New Tarpon Surfer Double Sticker

THE TIME IS NOW FOR THE LOWER SNAKE

The Snake River basin in Idaho is the biggest, most pristine area of salmon and steelhead spawning habitat left in the continental United States. The lower Snake River dams are driving these once massive runs of salmon and steelhead rapidly toward extinction. It is time to take down these aging dams and recover wild salmon and steelhead in the Snake River basin.

Join Umpqua in signing on to remove the lower four dams on the Snake River.



CONSERVATION





50

FRESHWATER

- WARM WATER
- DRY FLIES
- TERRESTRIALS
- MIDGES & EMERGERS
- NYMPHS
- JIGGED/ EURO
- EGGS & WORMS
- SCUDS & SHRIMP
- LAKE FLIES
- STREAMERS
- STEELHEAD



WARM WATER



53



ZIMMERMAN™

BALL PEEN CRAW

COLOR	SIZE	CODE	H
RUST	6	70677	
	8	70678	



BENNETT'S™

BENNETT'S™ LUNCH \$

COLOR	SIZE	CODE	KK
BROWN TROUT	2	70631	
	6	70632	
CRAWDAD	2	72028	
	6	72029	
RAINBOW	2	72026	
	6	72027	
SHAD	2	70635	
	6	70636	
TAN	2	70637	
	6	70638	



BARR'S™

BOUFACE BRASS BEAD

COLOR	SIZE	CODE	F
BLACK	8	10029	
	10	10030	



KRAFT'S™

CLAWDAD

COLOR	SIZE	CODE	J
BLUE/BLACK	2	72125	
	4	72126	
	6	72127	
BROWN	2	72787	
	4	72788	
	6	72789	

NEW



WHITE'S™

AKOBE FLY

COLOR	SIZE	CODE	J*
BLACK/RED	06	73935	
WHITE/RED	06	73936	
YEL/CHART	06	73937	



CLOUSER CRAYFISH

COLOR	SIZE	CODE	C*
DARK BROWN TURKEY	8	10210	
	10	10211	
OLIVE/GREEN	6	10200	
	8	10201	
TAN TURKEY	8	10205	
	10	10206	



CLOUSER MINNOW BABY SMALLMOUTH

COLOR	SIZE	CODE	G
BROWN/GREEN	2	16587	
	6	16585	



MILL'S™

COWBELL CRAW BRASS CONE

COLOR	SIZE	CODE	K
OLIVE	6	73081	
RUST	6	73080	
TAN	6	73079	



COWEN'S™

COYOTE hc

COLOR	SIZE	CODE	I*
BLUE/CHARTREUSE/WHITE	1	18281	
CHARTREUSE/WHITE	1	18273	



HADA'S™

CREEK CRAWLER

COLOR	SIZE	CODE	I*
DIRTY ORANGE	4	10715	
OLIVE	4	10716	
TAN	4	10717	



KRAFT'S™

CRITTERMITE

COLOR	SIZE	CODE	KK
BLACK	2	72775	
	4	72776	
	6	72777	



THALKEN'S™

CRUISER hc

COLOR	SIZE	CODE	M*
BLACK/PURPLE	3/0	70868	



HADDON'S™

DEAD DRIFT CRAYFISH

COLOR	SIZE	CODE	H
BROWN	8	11688	
OLIVE	8	11689	



GAMECHANGER hc

COLOR	SIZE	CODE	L*
PEARL/WHITE	2/0	70313	
RAINBOW	2/0	70314	



ZIMMERMAN'S™

GEEZUS LIZARD

COLOR	SIZE	CODE	K*
BLACK/OLIVE	1/0	19302	
CRAYFISH	1/0	19303	

BASS SUBSURFACE



GUMMY MINNOW hc

COLOR	SIZE	CODE	
BLUE	2	15752	J*
	6	15753	H*
BROWN	2	15086	J*
	6	15620	H*
CHARTREUSE	2	16170	J*
	6	16171	H*
CLEAR	6	15021	H*
GREEN	2	15087	J*
	6	15089	H*
PEARL	2	15088	J*
	6	15619	H*



HUD'S BUSHWHACKER

COLOR	SIZE	CODE	H*
BLUEGILL	1	70739	
SHAD	2/0	70391	
WHITE/CHART	2/0	70393	



KREELEX MINNOW

COLOR	SIZE	CODE	I
COPPER/GOLD	4	71861	
	6	71862	
	8	71863	
COPPER/GOLD/SILVER	4	71865	
	6	71866	
	8	71867	
GOLD/SILVER	4	71856	
	6	71857	
	8	71858	



MEAT WHISTLE

COLOR	SIZE	CODE	G*
BLACK	2	10701	
	1/0	10840	
CHARTREUSE	2	10704	
	1/0	10697	
CRAWDAD	2	10702	
	1/0	10844	
OLIVE	2	10703	
	1/0	10842	
VIRILE CRAYFISH	2	10695	
	1/0	10694	
WHITE	2	10705	
	1/0	10699	



MICRO CRAYFISH

COLOR	SIZE	CODE	E*
RUST	8	14955	



MIDNIGHT MINNOW hc

COLOR	SIZE	CODE	DD*
	6	19480	



MIDNIGHT MULLET hc

COLOR	SIZE	CODE	G*
	1/0	19500	

NEW



MOUNTAIN LOBSTER

COLOR	SIZE	CODE	KK
OLIVE	08	73906	
	12	73907	
ORANGE	08	73908	
	12	73909	



MURDICH™ MINI MINNOW hc

COLOR	SIZE	CODE	E*
CHARTREUSE/WHITE	4	70889	
COPPER	4	70891	
COPPER/YELLOW	4	70893	
GOLD	4	70892	
GRAY/WHITE	4	70888	



MURDICH™ MINNOW hc

COLOR	SIZE	CODE	H*
CHARTREUSE/WHITE	1/0	10800	
COPPER/WHITE	1/0	19497	
COPPER/YELLOW	1/0	70220	
GOLD/WHITE	1/0	19498	
GRAY/WHITE	1/0	10804	



MURDICH™ WIGGLER

COLOR	SIZE	CODE	F*
BLACK	2	18105	
ROOT BEER	2	18107	
TAN	2	18108	
WHITE	2	18109	



NEAR NUFF CRAYFISH

COLOR	SIZE	CODE	G*
BROWN	4	10020	
	6	10021	
	8	10022	
DIRTY OLIVE	4	10223	
	6	10224	
	8	10226	
ORANGE	4	10043	
	6	10044	
	8	10045	



NEAR NUFF SCULPIN

COLOR	SIZE	CODE	G
OLIVE	4	10231	
	6	10232	
	8	10233	
TAN	4	10227	
	6	10228	
	8	10229	



SOMETHIN ELSE

COLOR	SIZE	CODE	I
GRAY/ WHT	02	17310	
	04	17308	
OLIVE/ WHT	02	17311	
	04	17309	



SPACE INVADER HC

COLOR	SIZE	CODE	K*
BLOOD BAIT	2/0	71123	
BUTTERFLY	2/0	71124	
NIGHT RIDER	2/0	71125	



STAY HUNGRY STREAMER

COLOR	SIZE	CODE	K
CHARTREUSE/WHITE	2	13451	
SHINER	2	13455	



BABY BASS POPPER

COLOR	SIZE	CODE	H*
GREEN/WHITE	6	10050	



BASS POPPER

COLOR	SIZE	CODE	F*
CHARTREUSE SPLATTER	6	70649	
COLONEL MUSTARD	6	70651	
FL. GREEN SPLATTER	6	70653	
FROGGY BOTTOM	6	70655	
MOSS MAN	6	70663	
MR MIDNIGHT	6	70659	
MR MINNOW	6	70661	
ORANGE SPLATTER	6	70665	
SNOW WHITE	6	70667	



BASS POPPER WG

COLOR	SIZE	CODE	F*
CHARTREUSE SPLATTER	6	71285	
COLONEL MUSTARD	6	71287	
FL. GREEN SPLATTER	6	71289	
FROGGY BOTTOM	6	71291	
MOSS MAN	6	71299	
MR MIDNIGHT	6	71295	
MR MINNOW	6	71297	
ORANGE SPLATTER	6	71301	
SNOW WHITE	6	71303	



CREASE FLY HC

COLOR	SIZE	CODE	I*
BLACK BACK	1/0	16706	
	3/0	16705	
BLUE BACK	1/0	17755	
	3/0	17754	
FIRETIGER	1/0	16704	
OLIVE BACK	1/0	17751	
	3/0	17750	
SILVER	1/0	16717	
	3/0	16716	



CRYSTAL DAMSEL DRAGON

COLOR	SIZE	CODE	I*
BLUE	6	10018	
	10	10019	



DANCING FROG wg

COLOR	SIZE	CODE	J*
GREEN/YELLOW	2	10250	



DEERHAIR BASS BUG wg

COLOR	SIZE	CODE	I*
FROG	2	10498	
	6	10499	
	10	10500	



DIVING BUG wg

COLOR	SIZE	CODE	H*
FROG	2	10340	
	6	10341	



FLOATING SMELT

COLOR	SIZE	CODE	E*
PEARL	2	18334	
	6	18335	

BASS TOPWATER



FREAKY FROG w/g

COLOR	SIZE	CODE	J*
	2	70238	



KING RAT SMALL w/g

COLOR	SIZE	CODE	K*
	1	72089	



LOCO MOUSE

COLOR	SIZE	CODE	F*
	6	10062	



MESSINGER'S™ FROG w/g

COLOR	SIZE	CODE	KK*
	6	10262	
	10	10263	



MICRO POPPER

COLOR	SIZE	CODE	I
BLACK	10	10102	
	12	10103	
CHARTREUSE	10	10093	
	12	10094	
FROG	10	10099	
	12	10100	
WHITE	10	10096	
	12	10097	
YELLOW	10	10105	
	12	10106	



MICRO SLIDER

COLOR	SIZE	CODE	J
CHARTREUSE	10	10108	
WHITE	10	10110	



MINI MOUSE w/g

COLOR	SIZE	CODE	E*
NATURAL	10	10536	



MOUSERAT w/g

COLOR	SIZE	CODE	F*
BLACK	6	10535	
NATURAL	6	10534	
	10	10538	



PINEAPPLE GRENADE POPPER

COLOR	SIZE	CODE	KK*
BLUE/ WHITE	2/0	73554	
CHART FROG	2/0	73555	
PINK/ WHITE	2/0	73556	
TAN/ WHITE	2/0	73557	



SHENANDOAH CHUGGER

COLOR	SIZE	CODE	G*
CHARTREUSE	4	10460	
	6	10461	



SHENANDOAH POPPER

COLOR	SIZE	CODE	G*
BLUE	4	10448	
	6	10449	



SKIPPER

COLOR	SIZE	CODE	F*
FROG	1/0	10537	



SPARKY'S FLOATING SPIDER

COLOR	SIZE	CODE	K
BLACK	10	19718	



SPONGE SPIDER

COLOR	SIZE	CODE	D
BLACK	12	16837	



TEQUILA POPPER

COLOR	SIZE	CODE	G*
	1	SIG1601	



TODD'S WIGGLE MINNOW

COLOR	SIZE	CODE	G*
BROWN TROUT	2	10046	
	6	10047	
FIRE TIGER	2	10048	
	6	10049	
RAINBOW TROUT	2	10055	
	6	10056	
SHAD	2	10057	
	6	10058	
WHITE	2	10059	
	6	10066	



UMPQUA™ SWIMMING BAITFISH w/g

COLOR	SIZE	CODE	J*
RED/WHITE	1/0	15571	
RED/YELLOW	1/0	15576	
SHAD	1/0	15585	
	4	15570	



UMPQUA™ SWIMMING FROG w/g

COLOR	SIZE	CODE	K*
ORANGE BELLY	2	10657	
	6	10658	
	10	10659	
WHITE BELLY	2	10618	
	6	10619	
	10	10617	
YELLOW BELLY	2	10653	
	6	10654	
	10	10655	



WAKING MOUSE

COLOR	SIZE	CODE	L
	4	SIG0112	
	6	SIG1505	



WAKING MOUSE 2.0

COLOR	SIZE	CODE	KK
	2	SIG2266	



ZIMMERMAN'S™

BACKSTABBER

COLOR	SIZE	CODE	K
BLACK LEECH	6	17501	
OLIVE	6	17500	
RUSTY	6	17503	



ZIMMERMAN'S™

BALL PEEN CRAW

COLOR	SIZE	CODE	H
RUST	6	70677	
	8	70678	



REYNOLDS™

BARRY'S CARP BITTER

COLOR	SIZE	CODE	I
OLIVE	6	19927	
RUSTY	6	19928	



REYNOLDS™

BARRY'S CARP FLY

COLOR	SIZE	CODE	K
RUSTY	6	19392	



BONEFISH DEEP MINNOW

COLOR	SIZE	CODE	H
FOXEE REED	2	18456	
	4	18457	



BARR'S™

BOUFACE BRASS BEAD

COLOR	SIZE	CODE	F
BLACK	8	10029	
	10	100302	



EAKINS™

DETROIT MOP CITY

COLOR	SIZE	CODE	G
CREAM	LRG 02	73715	
	MED 02	73716	



GRILLOS™

GREAT CARPHOLIO JIG

COLOR	SIZE	CODE	K
BLACK	4	72797	
BROWN	4	72799	
OLIVE	4	72801	



EGAN'S™

HEADSTAND

COLOR	SIZE	CODE	E
CHARTREUSE	8	10031	
RUSTY ORANGE	8	10032	



EAKINS™

HIPSTER DUFUS

COLOR	SIZE	CODE	F
OB TAN	08	73718	
YB BROWN	08	73719	



EAKINS™

H.V.R.T. CARP FLY

COLOR	SIZE	CODE	E
GRHE	08	73717	



MAYER'S™

MAYER'S™ MINI LEECH

COLOR	SIZE	CODE	F
BLACK	14	70406	
	16	70407	
BROWN	14	70408	
	16	70409	



MERCER'S™

MICRO CRAYFISH

COLOR	SIZE	CODE	E*
RUST	8	14955	

CARP



NEAR NUFF CRAYFISH

COLOR	SIZE	CODE	G*
BROWN	4	10020	
	6	10021	
	8	10022	
DIRTY OLIVE	4	10223	
	6	10224	
	8	10226	
ORANGE	4	10043	
	6	10044	
	8	10045	



MERCER'S™

RAG HEX

COLOR	SIZE	CODE	J
	8	18184	



BECK'S™

SUPER BUGGER

COLOR	SIZE	CODE	H
BLACK	4	13374	
	6	13375	
	8	13376	
OLIVE	4	13364	
	6	13372	
	8	13373	
TAN	4	13633	
	6	13368	
	8	13369	

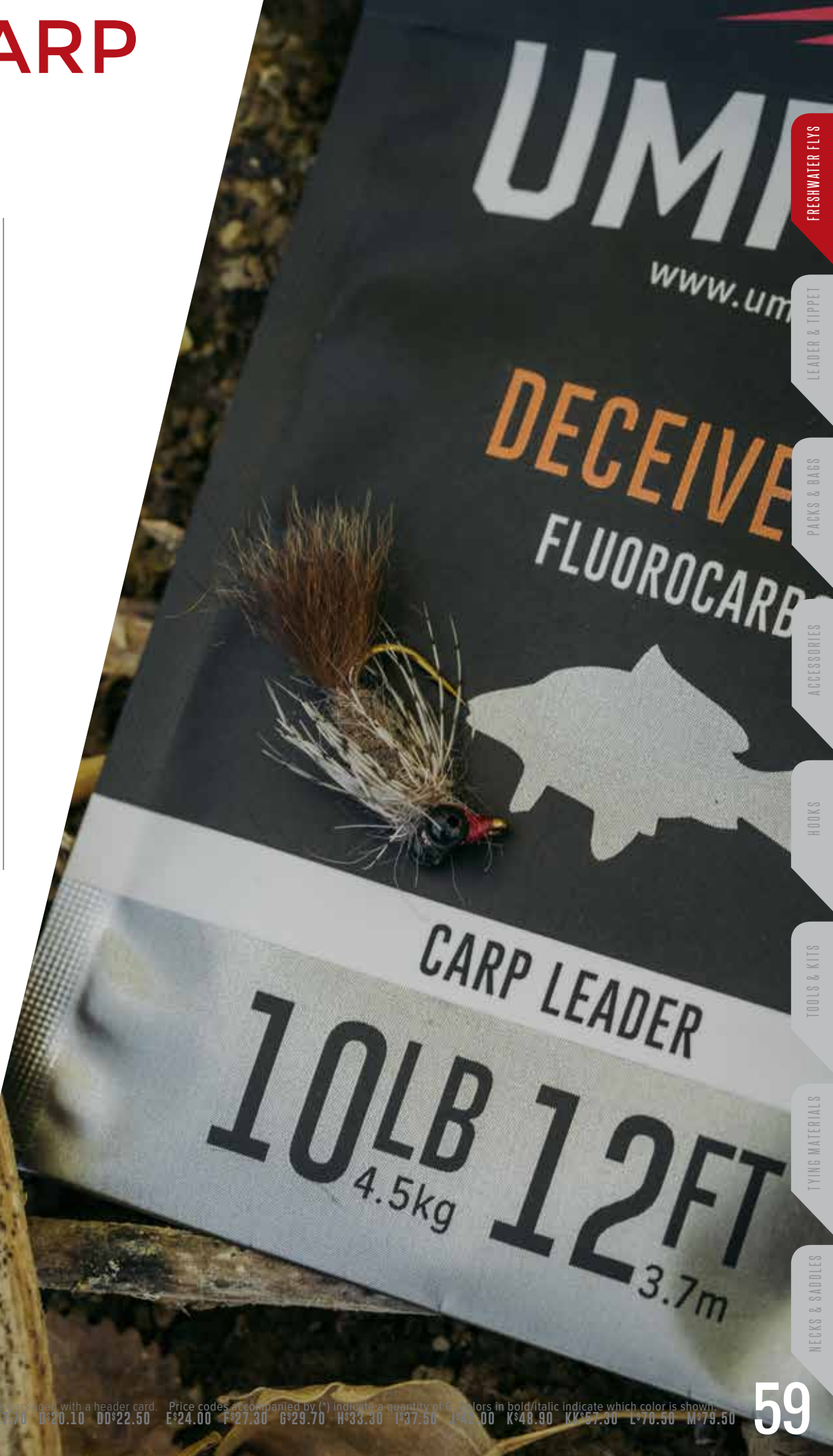

FRESHWATER FLYS

LEADER & TIPPET

PACKS & BAGS

ACCESSORIES

HOOKS

TOOLS & KITS

TYING MATERIALS

NECKS & SADDLES



BANGER hc

COLOR	SIZE	CODE	H*
CHARTREUSE	4/0	15383	
	2/0	15385	
SILVER	4/0	15382	
	2/0	15393	



BIG FISH DECEIVER hc

COLOR	SIZE	CODE	F*
BLUE/WHITE	3/0	15503	
CHARTREUSE/WHITE	3/0	15502	
GRAY/WHITE	3/0	15504	



CLOUSER MINNOW

COLOR	SIZE	CODE	H
CHARTREUSE/WHITE	2/0	16750	
PINK/WHITE	2/0	17141	
RED/WHITE	2/0	15120	
TUTTI FRUITI	2/0	16137	



BLADOS™

CREASE FLY hc

COLOR	SIZE	CODE	I*
BLACK BACK	3/0	16705	
BLUE BACK	3/0	17754	
FIRE TIGER	1/0	16704	
OLIVE BACK	3/0	17750	
SILVER	3/0	16716	



THALKEN'S™

CRUISER hc

COLOR	SIZE	CODE	M*
BLACK/PURPLE	3/0	70868	
CHARTREUSE/WHITE	2/0	18821	
SARDINA	2/0	18823	
SHAD	2/0	18826	



SKOK'S™

FLASHFIRE MUSHY hc

COLOR	SIZE	CODE	K*
CHARTREUSE/WHITE	2/0	17625	
GRAY/WHITE	2/0	17627	
OLIVE/WHITE	2/0	17626	



BLANTON'S™

FLASHTAIL WHISTLER hc

COLOR	SIZE	CODE	H*
ORANGE/YELLOW	3/0	15104	
RED/WHITE	3/0	15114	
RED/YELLOW	3/0	15119	



GAMECHANGER hc (4.5" LENGTH)

COLOR	SIZE	CODE	L*
PEARL/WHITE	2/0	70313	
RAINBOW	2/0	70314	



MALDONADO'S™

JUNGLE JUNKIE

COLOR	SIZE	CODE	K*
FIRE TIGER	4/0	73230	



JUNGLE LOVE hc

COLOR	SIZE	CODE	K*
BLACK/CHARTREUSE	2/0	70920	
BLACK/RED	2/0	70921	
BLACK/PURPLE	2/0	70922	



KINTZ'S™

MAJOR BUNKER hc

COLOR	SIZE	CODE	L*
GRAY/BROWN	4/0	15408	



ANDERSON'S™

REDUCER

COLOR	SIZE	CODE	K*
PEACOCK	3/0	12461	



SEA HABIT BUCKTAIL hc

COLOR	SIZE	CODE	H*
ANCHOVY	2/0	15245	
HERRING	2/0	15247	
SARDINE	2/0	15248	



ANDERSON'S™

SPACE INVADER hc

COLOR	SIZE	CODE	K*
BLOOD BAIT	2/0	71123	
BUTTERFLY	2/0	71124	
NIGHT RIDER	2/0	71125	



UMPQUA™ PIKE FLY wg

COLOR	SIZE	CODE	M*
CHARTREUSE/FROG	3/0	10680	



UMPQUA™ SWIMMING BAITFISH wg

COLOR	SIZE	CODE	J*
RED/WHITE	1/0	15571	
RED/YELLOW	1/0	15576	
SHAD	1/0	15565	

PEACOCK BASS/JUNGLE



Photos: Wesley White



- FRESHWATER FLYS
- LEADER & TIPPET
- PACKS & BAGS
- ACCESSORIES
- HOOKS
- TOOLS & KITS
- TYING MATERIALS
- NECKS & SADDLES

WG Flies have weed guards. **HL** Flies are packaged with a header card. Price codes accompanied by (*) indicate a quantity of 6. Colors in bold/italic indicate which color is shown.
PRICE CODES A*12.60 B*15.00 C*17.70 D*20.10 DD*22.50 E*24.00 F*27.50 G*29.70 H*32.50 I*37.50 J*42.00 K*48.90 KK*57.30 L*70.50 M*79.50



BALLOK'S™

BALLOK'S™ BIG BOY

COLOR	SIZE	CODE	B EA.
FIRE TIGER	6/0	70441	
ZOMBIE	6/0	70440	



REYNOLDS™

BARRY'S PIKE FLY

COLOR	SIZE	CODE	6*
BLACK	3/0	10672	
CHARTREUSE	3/0	10673	
RED/WHITE	3/0	10674	



BIG FISH DECEIVER hc

COLOR	SIZE	CODE	F*
BLUE/WHITE	3/0	15503	
CHARTREUSE/WHITE	3/0	15502	
GRAY/WHITE	3/0	15504	



CLOUSER MINNOW

COLOR	SIZE	CODE	H
BLACK	2/0	15110	
CHARTREUSE/WHITE	2/0	16750	
PINK/WHITE	2/0	17141	
RED/WHITE	2/0	15120	
TUTTI FRUITI	2/0	16137	



THALKEN'S™

CRUISER hc

COLOR	SIZE	CODE	M*
BLACK/PURPLE	3/0	70868	
CHARTREUSE/WHITE	2/0	18821	
SARDINA	2/0	18823	
SHAD	2/0	18826	



DECEIVER hc

COLOR	SIZE	CODE	D*
CHARTREUSE/WHITE	4/0	15472	
	2/0	15471	
RED/WHITE	2/0	15484	



SKOK'S™

FLASHFIRE MUSHY hc

COLOR	SIZE	CODE	K*
CHARTREUSE/WHITE	2/0	17625	
GRAY/WHITE	2/0	17627	
OLIVE/WHITE	2/0	17626	



BLANTON'S™

FLASHTAIL WHISTLER hc

COLOR	SIZE	CODE	H*
ORANGE/YELLOW	3/0	15104	
RED/WHITE	3/0	15114	
RED/YELLOW	3/0	15119	



GAMECHANGER hc (4.5" LENGTH)

COLOR	SIZE	CODE	L*
PEARL/WHITE	2/0	70313	
RAINBOW	2/0	70314	



HUDSPETH'S™

HUD'S BUSHWHACKER

COLOR	SIZE	CODE	H*
BLUEGILL	1	70739	
CHARTREUSE/WHITE	2/0	70393	
SHAD	2/0	70391	



KINTZ'S™

MAJOR BUNKER hc

COLOR	SIZE	CODE	L*
GRAY/BROWN	4/0	15408	



MURDICH'S™

MURDICH™ WIGGLER

COLOR	SIZE	CODE	F*
BLACK	2	18105	
ROOT BEER	2	18107	
TAN	2	18108	
WHITE	2	18109	



BALLOK'S™

NORTHWOODS NINJA

COLOR	SIZE	CODE	B EA.
FIRE TIGER	5/0	70443	



LEMAY'S™

PIKE/TARPON SNAKE hc

COLOR	SIZE	CODE	K*
BLACK	3/0	19256	
RED/WHITE	3/0	19259	



BOYER'S™

TODD'S WIGGLE MINNOW hc

COLOR	SIZE	CODE	H*
BAITFISH	2/0	10067	
CHARTREUSE	2/0	10068	
RED/WHITE	2/0	10069	



UMPQUA™ PIKE FLY wg

COLOR	SIZE	CODE	M*
CHARTREUSE/FROG	3/0	10680	



UMPQUA™ SWIMMING BAITFISH wg

COLOR	SIZE	CODE	J*
RED/WHITE	1/0	15571	
RED/YELLOW	1/0	15576	
SHAD	1/0	15565	

PIKE/MUSKIE



Photo: Wesley White

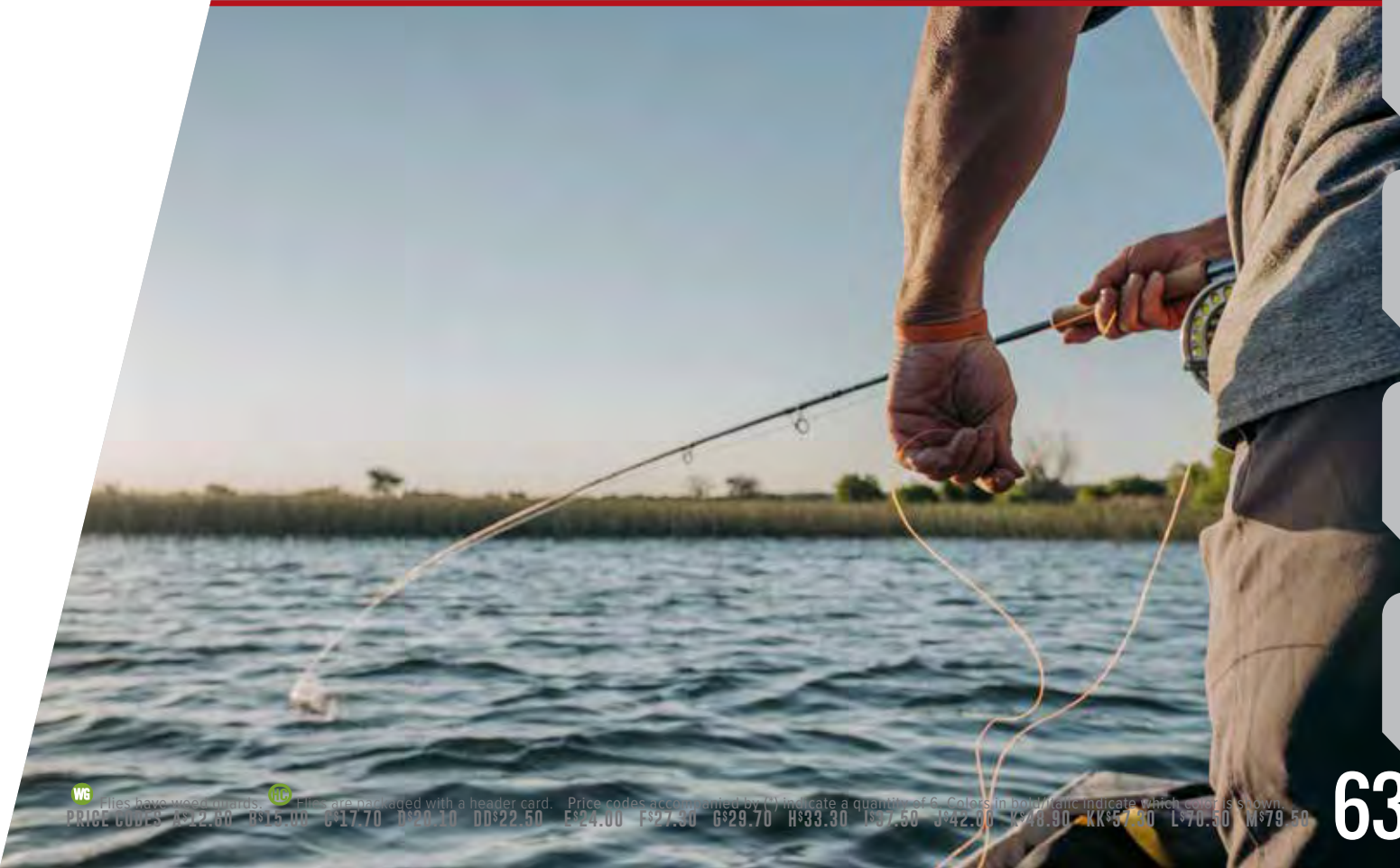

FRESHWATER FLYS

LEADER & TIPPET

PACKS & BAGS

ACCESSORIES

HOOKS

TOOLS & KITS

TYING MATERIALS

NECKS & SADDLES

WG Flies have wood guards. **ILP** Flies are packaged with a header card. Price codes accompanied by (*) indicate a quantity of 6. Colors in bold/italic indicate which color is shown.
PRICE CODES A\$12.00 H\$15.00 G\$17.70 D\$20.10 DD\$22.50 E\$24.00 F\$27.50 G\$29.70 H\$33.30 I\$37.50 J\$42.00 K\$48.90 KK\$57.00 L\$70.50 M\$79.50



THE GROSSWOLD | GHOOSTY | THE DISCO KID | F BONE | JETON STONK | BOOP'S MALONE |
112 113 114 115 116 117 118 119 120 121 122 123 124 125 126 127 128 129 130
DASS ARE YOU?
BIG HOLE
BBQ

CU-10

DRY FLIES



65



PEDERSON'S™

401K BAETIS

COLOR	SIZE	CODE	E
	16	73950	
	18	73951	
	20	73952	



YEAGER'S™

409

COLOR	SIZE	CODE	F
PURPLE	12	SIG2215	
	14	SIG2216	
	16	SIG2217	
YELLOW	12	SIG1204	
	14	SIG1205	
	16	SIG1722	



GRILLOS™

64 IMPALA

COLOR	SIZE	CODE	G
SALMON FLY	6	70695	



ADAMS

COLOR	SIZE	CODE	D
	12	11302	
	14	11303	
	16	11304	
	18	11305	
	20	11306	
	22	11307	



ADAMS SUPERFLY

COLOR	SIZE	CODE	F
GRAY	12	20097	
	14	20098	
	16	20099	



ADULT DAMSEL

COLOR	SIZE	CODE	DD
BLUE	14	11331	



BURK'S™

ADULT DAMSEL

COLOR	SIZE	CODE	F
BLUE	10	11333	



DENNIS™

AMY'S ANT

COLOR	SIZE	CODE	F
OLIVE	8	17044	
	10	17041	
	12	19518	
	14	19519	
RED	8	17049	
	10	17046	
	12	19520	
	14	19521	
PURPLE	8	72010	
	10	72011	
	12	72012	
	14	72063	



RODRIGUES™

ANTONIO'S ADULT MAYFLY

COLOR	SIZE	CODE	E
BWO	15	73276	
	17	73277	
	19	73278	
	21	73279	
MARCH BROWN	12	73281	
	14	73282	
PMD	15	73283	
	17	73284	
	19	73285	



RODRIGUES™

ANTONIO'S SUPERMAN CADDIS

COLOR	SIZE	CODE	F
BROWN	12	73305	
	14	73306	
	16	73307	
OLIVE	12	73866	
	14	73867	
	16	73868	
GINGER	12	73870	
	14	73871	
	16	73872	



BDE EXTENDED BODY

COLOR	SIZE	CODE	DD
GREEN DRAKE	10	20315	
	12	20316	



ANDREW'S™

BEAR'S HI-VIS BORCHERT MOOSETAIL

COLOR	SIZE	CODE	F
	10	19449	
	12	19450	
	14	19451	



KINGREY'S™

BETTER FOAM CADDIS

COLOR	SIZE	CODE	E
BLACK	16	SIG0468	
	18	SIG0469	
OLIVE	16	SIG0472	
TAN	14	SIG0474	
	16	SIG0475	
OCTOBER ORANGE	10	SIG1099	



BLACK GNAT

COLOR	SIZE	CODE	D
	14	12895	
	16	12896	
	18	12897	



BLUE WING OLIVE

COLOR	SIZE	CODE	D
	14	12930	
	16	12931	
	18	12932	
	20	12933	
	22	12934	



CADDIS VARIANT

COLOR	SIZE	CODE	DD
GINGER	14	12261	
	16	12262	

DRY FLIES



CAHILL

COLOR	SIZE	CODE	D
LIGHT	12	12965	
	14	12966	
	16	12967	
	18	12968	



MAYER'S™

CANDY SHOP CALLIBAETIS

COLOR	SIZE	CODE	C
	14	73784	
	16	73785	



WEILENMANN'S™

CDC & ELK

COLOR	SIZE	CODE	DD
	15	19648	
	17	19649	



ANTONIO'S ADULT MAYFLY ANTONIO RODRIGUES

“This pattern was developed with the need to be one step ahead of other competitors. As you know after a couple competition sessions everyone heard or saw the patterns you used and this one has been kept close to my vest for many many years.

My Adult uses a CDC split wing a straight hook and also the materials squirrel body, CDL tail, the perfect imitation for an adult mayfly.

It lands extremely soft on the water, floats very high, is easy to see, and fish take it like it is a natural time and time again.”

-Signature Tyer Antonio Rodrigues



CHUBBY CHERNOBYL

COLOR	SIZE	CODE	D
BLACK/ BLACK	08	73954	
	10	73955	
	12	73956	
	14	73957	
	16	73958	
BLACK/TAN	8	THP0112	
	10	THP0113	
	12	THP0114	
	14	THP0139	
GOLD	8	THP0071	
	10	THP0072	
	12	THP0090	
	14	THP0141	
OLIVE	8	THP0116	
	10	THP0117	
	12	THP0118	
	14	THP0143	
ORANGE	8	THP0120	
	10	THP0095	
	12	THP0096	
	14	THP0145	
PINK	8	THP0122	
	10	THP0123	
	12	THP0124	
	14	THP0147	
16	THP0148		

COLOR	SIZE	CODE	D
PTERONARCYS	6	THP0125	
	8	THP0126	
	10	THP0127	
	12	THP0128	
	14	THP0149	
	16	THP0150	
PURPLE	6	THP0129	
	8	THP0130	
	10	THP0131	
	12	THP0132	
	14	THP0137	
	16	THP0138	
RED	8	THP0068	
	10	THP0069	
	12	THP0091	
	14	THP0151	
	16	THP0152	
	16	THP0154	
ROYAL	6	THP0133	
	8	THP0134	
	10	THP0135	
	12	THP0136	
ROYAL/ PURPLE	08	73960	
	10	73961	
	12	73962	
	14	73963	
TAN	8	THP0098	
	10	THP0099	
	12	THP0100	
	14	THP0155	
UV CINNAMON	8	72240	
	10	72241	
	12	72242	
	14	72243	
16	72244		



CHUBBY NORMAN

COLOR	SIZE	CODE	D
	8	TSF0109	
	10	TSF0110	



SILVEY'S™

CHUBBY SALLY

COLOR	SIZE	CODE	DD
YELLOW	14	SIG2059	



QUIGLEY'S™

CLUSTER

COLOR	SIZE	CODE	E
PEACOCK	16	SIG2200	
	20	SIG1819	



COMPARADUN

COLOR	SIZE	CODE	D
BWO	16	11214	
	18	11216	
	20	11217	
PMD	16	11285	
	18	11286	
SULFUR	16	15710	
	18	15711	



COMPARADUN CDC BIOT

COLOR	SIZE	CODE	C
BWO	18	18575	
	20	18576	
PMD	16	18550	
	18	18551	
SULFUR	16	18547	
	18	18548	



EGAN'S™

CORN-FED CADDIS CDC

COLOR	SIZE	CODE	E
OLIVE	14	17423	
	16	17424	
	18	17425	
	20	74423	
TAN	14	17426	
	16	17427	
	18	17428	
	20	74424	
PEACOCK	14	74044	
	16	74045	
	18	74046	



EGAN'S™

CORN-FED CADDIS RUBBERLEGS CDC

COLOR	SIZE	CODE	E
OLIVE	14	72218	
	16	72219	
TAN	14	72215	
	16	72216	



EGAN'S™

CORN-FED SALLY CDC

COLOR	SIZE	CODE	E
YELLOW	14	19485	
	16	19486	



EGAN'S™

CORN-FED SPRUCE MOTH

COLOR	SIZE	CODE	E
	10	74419	
	12	74420	
	14	74421	
	16	74422	

DRY FLIES



QUIGLEY'S™

CRIME SCENE CADDIS

COLOR	SIZE	CODE	DD
	14	SIG1138	
	16	SIG1139	



GRILLOS™

DANCIN' RICKY

COLOR	SIZE	CODE	J
BLACK	10	72080	
	14	72081	
BROWN/TAN	10	72083	
	14	72084	
GOLD STONE	8	72076	
	10	72200	
PURPLE	10	72086	
	14	72087	
	16	72205	
SALMONFLY	4	72073	
	6	72074	
	8	72199	
SKWALA	10	72078	
	12	72201	
	14	72202	
ROYAL	08	73742	
	10	73743	
	12	73744	
	14	73745	



THALKEN'S™

DOUBLE DUTCH BUG

COLOR	SIZE	CODE	I
GOLDEN	10	19626	
PEACOCK	10	19632	



CRAVEN'S™

DRUNKEN SUZY

COLOR	SIZE	CODE	D
YELLOW	14	73663	
	16	73664	
	18	73665	



CUTTER'S™

E/C CADDIS

COLOR	SIZE	CODE	DD
OLIVE	14	11184	
	16	11185	
	18	11186	
TAN	14	12625	
	16	12626	
	18	12627	



GRILLOS™

EL CAMINO

COLOR	SIZE	CODE	G
GOLDEN	8	SIG1552	
SKWALA	10	70994	



FRESHWATER FLIES

LEADER & TIPPET

PACKS & BAGS

ACCESSORIES

HOOKS

TOOLS & KITS

TYING MATERIALS

NECKS & SADDLES



ANDREW'S™

BEAR'S HI-VIS BROWN DRAKE

COLOR	SIZE	CODE	E
	10	19415	



HOWARD'S™

BI-WING DRAKE

COLOR	SIZE	CODE	E
	10	73774	



NEALLEY'S™

BROWN DRAKE

COLOR	SIZE	CODE	F
	10	11196	



LAWSON'S™

BROWN DRAKE STANDARD

COLOR	SIZE	CODE	F
	10	12001	



LAWSON'S™

BROWN PARADRAKE

COLOR	SIZE	CODE	G
	10	12003	



CDC GREEN DRAKE PARACHUTE

COLOR	SIZE	CODE	E
	12	18584	



COLORADO GREEN DRAKE

COLOR	SIZE	CODE	E
	12	11735	



LANE'S™

DJL DRAKE

COLOR	SIZE	CODE	F
GRAY	12	73973	
GREEN	10	73974	
	12	73975	



OLIVERIO'S™

EVERGREEN EASTERN GREEN DRAKE

COLOR	SIZE	CODE	E
	8	11064	
	10	11065	



LAWSON'S™

EXTENDED BODY BROWN DRAKE

COLOR	SIZE	CODE	E
	10	70116	



LAWSON'S™

EXTENDED BODY GREEN DRAKE

COLOR	SIZE	CODE	E
	12	70117	



SILVEY'S™

FAST WATER DRAKE

COLOR	SIZE	CODE	F
GRAY WING	08	73893	
	10	73894	
GREEN WING	08	74075	
	10	74076	



NEALLEY'S™

GREEN DRAKE

COLOR	SIZE	CODE	G
	10	11197	



GREEN DRAKE PARACHUTE

COLOR	SIZE	CODE	DD
	10	MF00018	
	12	MF00019	



LAWSON'S™

GREEN DRAKE-PARADRAKE

COLOR	SIZE	CODE	F
	10	12009	
	12	12010	



LAWSON'S™

GREEN DRAKE STANDARD

COLOR	SIZE	CODE	F
	12	12005	



FOWLER'S™

GUNNISON GREEN DRAKE

COLOR	SIZE	CODE	E
	12	12015	



HAIRWING DRAKE

COLOR	SIZE	CODE	DD
GRAY	10	MF00005	
	12	MF00006	
GREEN	10	MF00011	
	12	MF00012	



HAIRWING DUN

COLOR	SIZE	CODE	E
COLORADO GREEN DRAKE	10	15763	
	12	15764	



RENDLE'S™

MAJESTIC AF

COLOR	SIZE	CODE	E
BROWN DRAKE	08	73855	
GREEN DRAKE	10	73856	



DENNIS'S™

PARAWULFF

COLOR	SIZE	CODE	F
GREEN DRAKE	10	12856	
	12	12857	



MERCER'S™

PROFILE GREEN DRAKE

COLOR	SIZE	CODE	I
	12	11091	

DRAKES



MATHEWS™

SPARKLE DUN

COLOR	SIZE	CODE	D
GRAY DRAKE	12	18892	
GREEN DRAKE	12	11121	



MATHEWS™

SPARKLE DUN IMPROVED

COLOR	SIZE	CODE	D
GRAY DRAKE	12	71234	
GREEN DRAKE	12	71233	



DJL DRAKE DANNY LANE

“The DJL Drake was conceived of when guiding the drake hatch on the lower Henry’s Fork in June 2017.

Nothing in my box matched the silhouette as closely as I wanted, so I began playing with deer hair and rubber legs.

A couple versions, a few updates, and 5 test seasons later, the DJL Drake as we know it is here.”

- Signature Tyer Danny Lane



ELK CADDIS

COLOR	SIZE	CODE	C	
BLACK	12	10880		
	14	10881		
	16	10882		
	18	10883		
BROWN	12	10890		
	14	10891		
	16	10892		
	18	10893		
OLIVE	10	10910		
	12	10911		
	14	10912		
	16	10913		
18	10914			
	NEW	10	10926	
		12	10927	
		14	10928	
16	10929			
	TAN	10	10905	
		12	10906	
		14	10907	
16		10908		
18	10909			
	YELLOW	12	10921	
		14	10922	
		16	10923	
18		10924		



ELK CADDIS HOT WING

COLOR	SIZE	CODE	D
OLIVE	12	11940	
	14	11941	
	16	11942	
	18	11943	
TAN	12	11934	
	14	11935	
	16	11936	
	18	11937	



OLIVERIO'S™

EVERGREEN COFFIN FLY

COLOR	SIZE	CODE	E
WHITE	10	11073	



LAWSON'S™

E-Z CADDIS

COLOR	SIZE	CODE	E
OLIVE	14	11053	
	16	11054	
	18	11057	
TAN	14	11055	
	16	11056	
	18	11058	



QUIGLEY'S™

FILM CRITIC

COLOR	SIZE	CODE	E
BWO	16	SIG1629	
	18	SIG1630	
	20	SIG1631	
	14	SIG1632	
CALLIBAETIS	16	SIG1633	
	14	SIG1634	
FLAV	10	SIG1635	
GREEN DRAKE	12	SIG1636	
	10	SIG1820	
GRAY DRAKE	12	SIG1821	
	16	SIG1637	
PINK	18	SIG1638	
	16	SIG1639	
PMD	18	SIG1640	



WHITE'S™

FLOATING WET

COLOR	SIZE	CODE	DD
BWO	16	73938	
	18	73939	
	20	73940	
CALLIBAETIS	14	73941	
	16	73942	
GREEN DRAKE	12	73943	
	14	73944	
HENDRICKSON	16	73945	
	16	73946	
PINK	18	73947	
	16	73948	
PMD	18	73949	



MERCER'S™

FLUSH FLOATER STONE

COLOR	SIZE	CODE	G
GOLDEN	8	10834	
SALMON FLY	4	10835	
	6	10836	
SKWALA	10	10838	



PAULSON'S™

FLUTTER BUG

COLOR	SIZE	CODE	H
SALMON FLY	6	19267	
	8	19268	



FLUTTERING STONE

COLOR	SIZE	CODE	G
GOLDEN	8	SIG2189	
SALMON FLY	6	SIG1809	



PUTERBAUGH'S™

FOAM CADDIS

COLOR	SIZE	CODE	E
BLACK	14	12599	
	16	12600	
	18	12601	
OLIVE	14	12602	
	16	12603	
	18	12604	
TAN	14	12606	
	16	12607	
	18	12608	



MERCER'S™

FOAM OCTOBER CADDIS SKATER

COLOR	SIZE	CODE	K
ORANGE	8	11622	



MERCER'S™

FOAM PARACHUTE

COLOR	SIZE	CODE	E
ADAMS	14	11063	
	16	11066	
	18	11067	
PINK CAHILL	16	11258	
	18	11259	

DRY FLIES CONTINUED



MATHEWS™

FOAM SPINNER

COLOR	SIZE	CODE	E
GREEN DRAKE	10	73775	
	12	73776	
PINK LADY	16	73777	D



GOLDEN STONE BARRED LEG

COLOR	SIZE	CODE	E
	8	SI60193	
	10	SI60194	
	12	SI61308	



PUTERBAUGH'S™

FOAM STONE

COLOR	SIZE	CODE	E
YELLOW	12	12597	
	14	12598	
	16	12596	



GRIFFITH'S GNAT

COLOR	SIZE	CODE	D
	16	15695	
	18	15696	
	20	15697	
	22	15698	



OLSEN'S™

FRONT END LOADER

COLOR	SIZE	CODE	F
GOLDEN	12	71983	
	14	71984	
	16	71985	
TAN	12	71565	
	14	71566	
	16	71567	



GODDARD CADDIS

COLOR	SIZE	CODE	DD
ORIGINAL	12	10957	
	14	10958	
	16	10959	
	18	10960	



GRIFFITH'S GNAT HI-VIS

COLOR	SIZE	CODE	D
PINK WING	18	12364	
	20	12365	
	22	12366	



THARRETT'S™

GT TRIPLE DOUBLE

COLOR	SIZE	CODE	F
AMBER	12	12722	
	14	12723	
	16	12724	
BLACK	12	12725	
	14	12726	
	16	12727	
PURPLE	12	12731	
	14	12732	
	16	12733	



GULPER SPECIAL

COLOR	SIZE	CODE	D
OLIVE	16	11750	
	18	11751	
	20	11752	



H&L VARIANT

COLOR	SIZE	CODE	E
	10	11898	
	12	11899	
	14	11901	
	16	11902	



QUIGLEY'S™

HACKLE STACKER DUN

COLOR	SIZE	CODE	E
BWO	16	MFS0034	
	18	MFS0035	
	20	MFS0036	
	22	SIG1146	
CALLIBAETIS	14	MFS0048	
	16	MFS0037	
FEMALE TRICO	20	SIG0649	
	22	SIG0650	
MALE TRICO	20	SIG0651	
	22	SIG0652	
PINK	16	MFS0039	
	18	MFS0040	
PMD	16	MFS0032	
	18	MFS0033	
	20	MFS0049	
RUST	16	SIG0653	
	18	SIG0654	



HAIRWING DUN

COLOR	SIZE	CODE	E
COLORADO GREN DRAKE	10	15763	
	12	15764	



HAIRWING YELLOW SALLY

COLOR	SIZE	CODE	D
	14	TSF0010	
	16	TSF0046	



HEADLIGHT SALLY

COLOR	SIZE	CODE	DD
YELLOW	14	12019	
	16	12020	



LAWSON'S™

HEMINGWAY CADDIS

COLOR	SIZE	CODE	E
	14	11060	
	16	11061	
	18	11062	



HENDRICKSON

COLOR	SIZE	CODE	D
LIGHT	12	13022	
	14	13023	



LAWSON'S™

HENRY'S FORK FOAM STONE

COLOR	SIZE	CODE	F
GOLDEN	8	70118	
	10	70119	
	12	72259	
	14	72260	
	16	72261	
SALMON	4	70120	
	6	70121	
	8	72262	



LAWSON'S™

HENRY'S FORK YELLOW SALLY

COLOR	SIZE	CODE	E
	14	12021	
	16	12022	



NEALLEY'S™

HEX ADULT

COLOR	SIZE	CODE	E
	6	11195	



HEX ADULT DEER BODY

COLOR	SIZE	CODE	I
DEER BODY	6	11858	



GRILLOS™

HIPPIE STOMPER

COLOR	SIZE	CODE	G
BLACK	12	SIG1741	
	14	SIG1742	
	16	SIG1743	
BROWN	12	71010	
	14	71011	
	16	71012	
LIME	12	SIG1744	
	14	SIG1745	
	16	SIG1746	
ORANGE	12	71016	
	14	71017	
	16	71018	
PINK	12	70721	
	14	70722	
	16	70723	
PURPLE	10	SIG2118	
	12	SIG2119	
	14	SIG2120	
	16	SIG2121	
RED	12	SIG1747	
	14	SIG1748	
	16	SIG1749	
ROYAL	12	70703	
	14	70704	
	16	70705	
SPRUCE MOTH	10	73746	
	12	73747	
	14	73748	
	16	73749	
YELLOW	12	70715	
	14	70716	
	16	70717	

DRY FLIES



HUMPY

COLOR	SIZE	CODE	DD
RED	12	11852	
	14	11853	
	16	11854	
ROYAL	12	11865	
	14	11866	
	16	11867	
YELLOW	12	11888	
	14	11889	
	16	11890	
	18	11891	



WILCOX'S™

JC SPECIAL

COLOR	SIZE	CODE	G
GRAY	14	SIG0717	
	16	SIG1669	
	14	SIG0720	
OLIVE	14	SIG0720	
	16	SIG1670	
	14	SIG0723	
PHEASANT TAIL	14	SIG0723	
	16	SIG1190	



VAN WOERT'S™

JOSH'S COSMIC CRANE

COLOR	SIZE	CODE	H
	06	73122	
	10	73123	



MATHEWS™

IRIS CADDIS

COLOR	SIZE	CODE	DD
OLIVE	17	18732	
TAN	17	18736	



IRRESISTIBLE

COLOR	SIZE	CODE	E
ADAMS	12	11925	
	14	11926	
	16	11927	



DORSEY'S™

LIMEADE

COLOR	SIZE	CODE	E
LIMEADE	12	11117	
	14	74007	
	16	11122	
	18	74008	
CHERRY	12	11148	
	14	74009	
	16	11156	
	18	74010	



IWANE'S™

IWAN-E-DUN PARA

COLOR	SIZE	CODE	E
BWO	18	71524	
	20	71525	
	22	71526	
PMD	16	71527	
	18	71528	
TRICO	20	71974	
	22	71975	
	24	71976	



SILVEY'S™

LITTLE OLIVE STONE SKWALA

COLOR	SIZE	CODE	E
	12	SIG0237	



LITTLE YELLOW STONE FEMALE

COLOR	SIZE	CODE	DD
	14	12106	
	16	12107	



IWAN-E-DUN PHIL IWANE

"I wanted to create a mayfly pattern that was more realistic and caught more fish.

The important parts of an effective fly are the gape of the hook and a silhouette or imitation of the actual natural insect.

So I picked out the TMC 2488 hook which has a large gape, especially in smaller sizes, compared to the TMC 100 or 101 typically used for dry fly patterns.

Then I wanted to create an extended body, the standard body as you know is a dubbed abdomen, so I wanted to create an abdomen that was extended and looked like the natural.

I tried many different techniques but the one that worked the best was using monofilament for the body and micro-fibrets for the tails."

- Signature Tyer Phil Iwane



CUTTER'S™

LITTLE YELLOW STONEFLY

COLOR	SIZE	CODE	E
YELLOW/ORANGE	16	11187	
	14	11190	



MAKTIMA'S™

LOW WATER BAETIS

COLOR	SIZE	CODE	DD
OLIVE	18	70255	
	20	70256	



MADAM X PARACHUTE

COLOR	SIZE	CODE	E
PEACOCK	10	10308	
	12	10309	
	14	10310	
	16	10311	
PURPLE	12	71979	
	14	71980	
	16	71981	
ROYAL	10	10273	
	12	10274	
	14	10275	
	16	10276	
YELLOW	10	10277	
	12	10278	
	14	10279	
	16	10280	



RENDLE'S™

MAJESTIC AF

COLOR	SIZE	CODE	E
BROWN DRAKE	08	73855	
GREEN DRAKE	10	73856	
HARE'S EAR	12	73857	
	14	73858	
	16	73859	
PMD	14	73860	
	16	73861	
PURPLE	12	73862	
	14	73863	
	16	73864	



A.K.'S™

MARCH BROWN

COLOR	SIZE	CODE	DD
EASTERN	12	11098	
	14	11099	



FLICK'S™

MARCH BROWN

COLOR	SIZE	CODE	DD
	12	11411	
	14	11412	



MAY DAY

COLOR	SIZE	CODE	E
BWO	17	70619	
	19	70620	
PMD	17	70622	
	19	70623	
CALLIBAETIS	13	70624	
	15	70625	



A.K.'S™

MELON QUILL

COLOR	SIZE	CODE	E
	16	13171	
	18	13172	



JOHNSON'S™

MIMIC MAY

COLOR	SIZE	CODE	DD
BWO	16	73646	
	18	73647	
	20	73648	
ISO	12	73649	
	14	73650	
LT CAHILL	14	73651	
	16	73652	
PMD	16	73653	
	18	73654	



GRILLOS™

MINI HIPPIE STOMPER

COLOR	SIZE	CODE	F
BLACK	16	73750	
	18	73751	
PINK	16	73753	
	18	73754	
PURPLE	16	73756	
	18	73757	
RED	16	73759	
	18	73760	
YELLOW	16	73762	
	18	73763	



GARCIA'S™

MINI HOT

COLOR	SIZE	CODE	E
HOT GREEN	16	19304	
	18	19305	
HOT YELLOW	16	19307	
	18	19308	
PURPLE	16	19313	
	18	19314	
TAN	16	19316	
	18	19317	



GARCIA'S™

MINI HOT MAYFLY

COLOR	SIZE	CODE	DD
BLACK	16	73155	
	18	73156	
	20	73157	
	22	73158	
OLIVE	16	73160	
	18	73161	
	20	73162	
	22	73163	
PURPLE	14	73139	
	16	73140	
	18	73141	
	20	73142	
	22	73143	
TAN	14	73144	
	16	73145	
	18	73146	
	20	73147	
	22	73148	
YELLOW	14	73149	
	16	73150	
	18	73151	
	20	73152	



MERCER'S™

MISSING LINK

COLOR	SIZE	CODE	DD
GREEN DRAKE	12	19751	
OLIVE	16	19752	
	18	19753	
	20	19754	
RED	14	19755	
	16	19756	
	18	19757	
YELLOW	14	19758	
	16	19759	
	18	19760	
PMD	14	72248	
	16	72249	
	18	72250	
SALLY	14	72252	
	16	72253	

DRY FLIES



MERCER'S™

MISSING LINK CADDIS

COLOR	SIZE	CODE	DD
AMBER	14	72256	
	16	72257	
	18	72258	
DARK	12	72254	
	14	12492	
	16	12493	
	18	12494	



GARCIA'S™

MOTHER'S DAY CADDIS

COLOR	SIZE	CODE	E
BLACK	14	11027	
	16	11028	
	18	11029	



GARCIA'S™

MOTHER'S DAY SALLY

COLOR	SIZE	CODE	E
	14	71987	
	16	71988	



MURRAY'S™

MR. RAPIDAN

COLOR	SIZE	CODE	E
	12	18240	
	14	18241	
	16	18242	

NEW



CRAVEN'S™

MR. JONES

COLOR	SIZE	CODE	H
CRANEFLY	10	73668	
	14	73669	



MUTANT STONE

COLOR	SIZE	CODE	E
RED	8	SIG0787	
	10	SIG0788	

NEW



UMPQUA'S™

NAKED CHUBBY

COLOR	SIZE	CODE	DD
GOLDEN	06	74505	
	08	74506	
	10	74507	
	12	74508	
	14	74509	
	16	74510	
OLIVE	06	74529	
	08	74530	
	10	74531	
	12	74532	
ORANGE	14	74533	
	16	74534	
	06	74523	
	08	74524	
	10	74525	
	12	74526	
	14	74527	
	16	74528	
PURPLE	06	74499	
	08	74500	
	10	74501	
	12	74502	
	14	74503	
	16	74504	
	06	74511	
	08	74512	
ROYAL	10	74513	
	12	74514	
	14	74515	
	16	74516	
TAN	06	74517	
	08	74518	
	10	74519	
	12	74520	
	14	74521	
	16	74522	



YEAGER'S™

NEVERSINK CADDIS

COLOR	SIZE	CODE	E
OLIVE	14	SIG1397	
	16	SIG1398	
TAN	14	SIG1399	
	16	SIG1400	



YEAGER'S™

NEVERSINK SALLY

COLOR	SIZE	CODE	F
	14	SIG1407	
	16	SIG1408	



LAWSON'S™

NO HACKLE

COLOR	SIZE	CODE	D
GRAY OLIVE	20	15924	
	22	15925	
GRAY YELLOW	16	15918	
	18	15919	



POTTER'S™

OCTOBER CADDIS

COLOR	SIZE	CODE	F
RUSTY	8	70136	
	10	70137	



OCTOBER CADDIS ADULT

COLOR	SIZE	CODE	F
	8	SIG0111	



MOSQUITO

COLOR	SIZE	CODE	D
	12	11422	
	14	11423	
	16	11424	
	18	11425	



SLOAN'S™

OUTRIGGER CADDIS

COLOR	SIZE	CODE	F
OLIVE	14	10940	
	16	10941	
TAN	14	10943	
	16	10944	



SLOAN'S™

OUTRIGGER YELLOW SALLY

COLOR	SIZE	CODE	F
	14	14175	
	16	14176	

NEW



RUSSELL'S™

PABLO'S CRIPPLE

COLOR	SIZE	CODE	DD
BAETIS	18	74435	
	20	74436	
PMD	16	74433	
	18	74434	
TRIDGE	20	74437	
	22	74438	



BIRCHBY'S™

PARA DAMSEL

COLOR	SIZE	CODE	G
BLUE	14	73645	



PARACHUTE

COLOR	SIZE	CODE	D
ADAMS	12	12041	
	14	12042	
	16	12043	
	18	12044	
	20	12045	
	22	12046	
	24	12047	
	26	12048	
BLUE OLIVE	14	12066	
	16	12067	
	18	12068	
	20	12069	
	22	12070	
CAHILL	12	12073	
	14	12074	
	16	12075	
PMD	16	MPS0048	
	18	MPS0049	
PURPLE	14	12252	
	16	12253	
	18	12254	
SULFUR	14	11341	
	16	11110	
	18	11111	
UV CINNAMON	14	72236	
	16	72237	
	18	72238	
UV PURPLE	12	72232	
	14	72233	
	16	72234	
	18	72235	



A.K.'S™

PARACHUTE

COLOR	SIZE	CODE	E
RED QUILL	16	11694	
	18	11695	



PARACHUTE CADDIS

COLOR	SIZE	CODE	DD
DARK OLIVE	14	SIG0319	
	16	SIG0320	
TAN	12	SIG0315	
	14	SIG0316	
	16	SIG0317	



KINSEY'S™

PARACHUTE HI-VIS

COLOR	SIZE	CODE	DD
BAETIS	18	19733	
	20	19734	
	22	19728	
PMD	16	19735	
	18	19736	



PARACHUTE HI VIS ADAMS

COLOR	SIZE	CODE	DD
	14	MPS0086	
	16	MPS0087	
	18	MPS0088	
	20	MPS0089	



PARACHUTE YELLOW SALLY

COLOR	SIZE	CODE	DD
	14	TSF0024	
	16	TSF0045	



DENNIS'S™

PARAWULFF

COLOR	SIZE	CODE	F
ADAMS	10	11030	
	12	11031	
	14	11032	
	16	11033	
	18	11034	
BWO	16	11040	
	18	11041	
GREEN DRAKE	10	12856	
	12	12857	
PMD	16	11048	
	18	11049	
PURPLE	12	12306	
	14	12307	
	16	12308	
	18	12309	



PEACOCK CADDIS

COLOR	SIZE	CODE	D
	12	11085	
	14	11086	
	16	11087	
	18	11088	



POTTER'S™

PEARL AND ELK CADDIS

COLOR	SIZE	CODE	DD
	14	11365	
	16	11366	
	18	11367	



SMITHERMAN'S™

PINT CADDIS

COLOR	SIZE	CODE	G
BLACK	18	73910	
TAN	16	73911	
	18	73912	
MILLER	16	74319	
	18	74320	
OLIVE	16	74321	
	18	74322	

NEW

NEW

DRY FLIES



LAWSON'S™

PMD			
COLOR	SIZE	CODE	DD
	16	13073	
	18	13074	



BECK'S™

POLYFLUFF CADDIS			
COLOR	SIZE	CODE	E
BLACK	12	74189	
	14	74190	
	16	74191	
	18	74192	
TAN	12	74193	
	14	74194	
	16	74195	
	18	74196	



QUILL GORDON

COLOR	SIZE	CODE	D
	14	13084	
	16	13085	



FREED'S™

RAZOR MAYFLY			
COLOR	SIZE	CODE	E
BAETIS	16	73182	
	18	73183	
	20	73184	
	16	73186	
PMD	18	73187	
	16	73189	
PINK	18	73190	
	10	73192	
GREEN DRAKE	12	73193	



RED QUILL

COLOR	SIZE	CODE	D
	12	13095	
	14	13096	
	16	13097	



RENEGADE

COLOR	SIZE	CODE	D
	10	13105	
	12	13106	
	14	13107	
	16	13108	
	18	13109	



GERBEC'S™

RESTING CADDIS

COLOR	SIZE	CODE	E
OLIVE	14	72221	
	16	72222	
TAN	14	72223	
	16	72224	



SCHLOTTER'S™

ROGUE FOAM STONE

COLOR	SIZE	CODE	F
GIANT ORANGE	4	10859	
	6	10858	
	6	10860	
GOLDEN	8	10861	
	10	10982	
	12	70276	
SKWALA	10	10856	
	12	10857	



ROYAL COACHMAN

COLOR	SIZE	CODE	D
	12	13126	
	14	13127	
	16	13128	



BURK'S™

SILHOUETTE DUN

COLOR	SIZE	CODE	DD
BWO	18	11629	
	20	11630	
PMD	16	11624	
	18	11625	



NEAL'S™

SKOPPER

COLOR	SIZE	CODE	F
YELLOW	12	72210	
	14	72211	



SKWALA

COLOR	SIZE	CODE	F
	10	TSF0066	
	12	TSF0107	



BEFUS™

SLOW WATER SALLY

COLOR	SIZE	CODE	DD
	14	11417	
	16	11418	



MATHEWS™

SPARKLE DUN

COLOR	SIZE	CODE	D
BAETIS OLIVE	18	15818	
	20	15819	
	22	11130	
BAETIS GRAY OLIVE	18	15798	
	20	15799	
	22	15800	
CALLIBAETIS	14	11116	
	16	15796	
GRAY DRAKE	12	18892	
GREEN DRAKE	12	11121	
MARCH BROWN	12	15826	
	14	15827	
PMD CREAM/YELLOW	14	74408	
	16	15804	
	18	15805	
PMD YELLOW/ORANGE	16	15793	
	18	15794	
SULFUR	16	15810	
	18	15811	



MATHEWS™

SPARKLE DUN IMPROVED

COLOR	SIZE	CODE	D
BAETIS OLIVE	18	71254	
	20	71255	
	22	71256	
BAETIS GRAY OLIVE	18	71228	
	20	71229	
	22	71230	
GRAY DRAKE	12	71234	
GREEN DRAKE	12	71233	
PMD/YELLOW/ORANGE	16	71236	
	18	71237	
SULFUR	16	71238	
	18	71239	
PINK LADY	16	71826	
	18	71827	



A.K.'S™

CALLIBAETIS SPINNER

COLOR	SIZE	CODE	DD
	16	12586	



CDC BIOT SPINNER

COLOR	SIZE	CODE	C
CALLIBAETIS	16	15984	
PMD	16	16002	
	18	16003	
RUSTY	14	15977	
	16	15978	
	18	15979	
	20	15980	
TRICO	20	15981	
	22	15982	
	24	15985	



CHUBBY TRICO SPINNER

COLOR	SIZE	CODE	D
	20	70065	
	22	70066	
	24	70067	
NEW FEMALE	20	74658	
	22	74659	
	24	74660	



ANDREWS™

CLEAR WING SPINNER BROWN DRAKE

COLOR	SIZE	CODE	F
	8	19434	
	10	19435	



ANDREWS™

CLEAR WING SPINNER HEX

COLOR	SIZE	CODE	J



ANDREWS™

CLEAR WING SPINNER TRICO

COLOR	SIZE	CODE	D
	20	19442	
	22	19443	



OLIVERIO'S™

CRYSTAL WING SPINNER

COLOR	SIZE	CODE	D
RUSTY	16	11820	
	18	11821	



BARR'S™

DROWNED SPINNER

COLOR	SIZE	CODE	DD
TRICO	18	70530	
	20	11164	
	22	11165	



FLAV SPINNER

COLOR	SIZE	CODE	D
	14	SIG0281	



MATHEWS™

FOAM SPINNER

COLOR	SIZE	CODE	E
GREEN DRAKE	10	73775	
	12	73776	
PINK LADY	16	73777	D



MATHEWS™

GRAY DRAKE FOAM SPINNER

COLOR	SIZE	CODE	E
	12	18893	



HEX SPINNER

COLOR	SIZE	CODE	E
	4	12824	



MATHEWS™

HI-VIS RUSTY SPINNER

COLOR	SIZE	CODE	DD
	16	19715	
	18	19716	



POTTER'S™

LIGHTHOUSE SPINNER

COLOR	SIZE	CODE	E
DRAKE	10	73850	
HEX	06	73851	
RUSTY	14	73852	D
	16	73853	
	18	73854	



NEAL'S™

PARA SPINNER

COLOR	SIZE	CODE	E
RUST	16	73117	
	18	73118	



POTTER'S™

POTTER'S™ PEARL BUTT TRICO

COLOR	SIZE	CODE	D
	20	11479	
	22	11480	



MERCER'S™

PROFILE SPINNER

COLOR	SIZE	CODE	G
HEX	6	71350	
RUSTY	16	11082	E
	18	11083	



MAYER'S™

SINK IT SPINNER

COLOR	SIZE	CODE	E
BWO	16	73786	
PMD	14	73787	
TRICO	20	73788	



SPINNER

COLOR	SIZE	CODE	C
RUSTY	16	MSW0014	
	18	MSW0015	

SPINNERS



MAYER'S™

TAILS UP TRICO

COLOR	SIZE	CODE	DD
BLACK	18	71500	
	20	71501	
	22	71502	
OLIVE	18	71503	
	20	71504	
	22	71505	



TRICO FEMALE POLY SPINNER

COLOR	SIZE	CODE	D
BLACK/OLIVE	20	16087	
	22	16073	



TRICO MALE POLY SPINNER

COLOR	SIZE	CODE	D
BLACK/WHITE	20	16085	
	22	16078	



TWO WING TRICO SPINNER

COLOR	SIZE	CODE	C
	18	MSW0024	
	20	MSW0025	



FOAM SPINNER CRAIG MATHEWS

“This spinner evolved a few years back on the Yellowstone River. The cutthroat trout there can be extremely tough to fool late in the season, and we needed a fly that would float well, present the proper silhouette, and would not twist fine tippets even 5 and 6x necessary for success.

Casting a large spinner on fine tippets is a recipe for tippet disaster so we decided to use hackle to imitate the wings on this fly. It minimizes twisting while maintaining the perfect spinner profile. And, a large hook always needs help floating, especially when the fly is sparse in design.

That’s why we decided on closed cell foam over the wings that gives additional floatation while allowing the perfect fly outline. A standard tail and dubbed body complete this deadly spinner pattern.”

- Signature Tyer Craig Mathews



QUIGLEY'S™

SPARKLE FLAG

COLOR	SIZE	CODE	DD
BWO	18	SIG0666	
	20	SIG0667	
PINK	16	SIG0919	
	18	SIG0920	
PMD	16	SIG0921	
	18	SIG0922	



LAWSON'S™

SPENT PARTRIDGE CADDIS

COLOR	SIZE	CODE	E
PEACOCK	16	18261	
	18	18262	
TAN	16	11078	
	18	11079	



QUIGLEY'S™

SPLIT FLAG

COLOR	SIZE	CODE	E
ADAMS	10	SIG1679	
	12	SIG1147	
	14	SIG1148	
	16	SIG1149	
18	SIG1150		
	PMD	16	SIG0915
	18	SIG0916	



JOHNSON'S™, CHRIS

SPRUCE ALMIGHTY

COLOR	SIZE	CODE	E
CREAM	12	71923	
	14	71924	



QUIGLEY'S™

STACKED SALLY

COLOR	SIZE	CODE	E
	14	SIG0258	
	16	SIG0259	

NEW



MERCER'S™

STEALTH LINK

COLOR	SIZE	CODE	H-J
GREEN DRAKE	10	73823	I
	12	73824	
	16	73825	H
BWO	18	73826	
	20	73827	
	22	73828	
	CALLIBAETIS	14	73829
	16	73830	
HEX	06	73831	J
PMD	16	73832	H
	18	73833	
	20	73834	



STILL STONE

COLOR	SIZE	CODE	I
GOLDEN	8	SIG2193	
SALMONFLY	6	SIG1815	



KAUFMANN'S™

STIMULATOR

COLOR	SIZE	CODE	DD
OLIVE	10	11966	
	12	11967	
	14	11968	
	16	11969	
ORANGE	8	11977	
	10	11978	
	12	11979	
	14	11980	
ROYAL	16	11981	
	10	11996	
	12	11997	
	14	11998	
16	11999		
	TAN	12	11972
	14	11973	
16	11974		
	YELLOW	10	11990
	12	11991	
	14	11992	
16	11993		



KAUFMANN'S™

STIMULATOR CRYSTAL

COLOR	SIZE	CODE	G
TAN	12	12248	
	14	12249	
	16	12250	
YELLOW	12	12163	
	14	12164	
	16	12165	



KAUFMANN'S™

STIMULATOR CRYSTAL RUBBERLEGS

COLOR	SIZE	CODE	G
PURPLE	10	72013	
	12	72014	
	14	72015	
	16	72016	
ORANGE	10	12126	
	12	12127	
	14	12119	
16	12128		
	ROYAL	10	12134
	12	12135	
14	12136		
	16	12137	
YELLOW	10	12325	
	12	12326	
	14	12327	
	16	12328	

DRY FLIES CONTINUED



STUBBY CHUBBY

COLOR	SIZE	CODE	DD
TAN LT	12	73990	
	14	73991	
	16	73992	
	18	73993	
BROWN/GOLD LT	12	73994	
	14	73995	
	16	73996	
	18	73997	
UV CINNAMON	12	72191	
	14	72192	
	16	72193	
	18	72194	
UV LIGHT YELLOW	12	72187	
	14	72188	
	16	72189	
	18	72190	
UV PURPLE	12	72195	
	14	72196	
	16	72197	
	18	72198	
UV TAN	12	72183	
	14	72184	
	16	72185	
	18	72186	



SULFUR DUN

COLOR	SIZE	CODE	D
	14	12379	
	16	12380	
	18	12381	



FREED'S

SUMMER STONE

COLOR	SIZE	CODE	E
UV YELLOW	12	72162	
	14	72163	



JOHNSON'S™, CHRIS

SUPER SALLY

COLOR	SIZE	CODE	F
	14	72049	
	16	72050	



GRILLOS™

SUPERIOR SPRUCE MOTH

COLOR	SIZE	CODE	G
	12	72271	
	14	72272	



TAKAHASHI'S™

TAK'S EGG LAYING CADDIS

COLOR	SIZE	CODE	F
GREEN	14	73164	
	16	73165	
	18	73166	



SEXTON'S™

THE GUNCH

COLOR	SIZE	CODE	E
PEACOCK/ORANGE	14	72229	
	16	72230	



LAWSON'S™

THORAX

COLOR	SIZE	CODE	D
PMD	16	15961	
	18	15962	



TILT WING DUN

COLOR	SIZE	CODE	C
BWO	18	MFS0051	
	20	MFS0052	
MAHOGANY	14	MFS0068	
	16	MFS0058	



BEST'S™

TRICO DUN

COLOR	SIZE	CODE	D
BLACK/GREEN	20	11686	
	22	11687	



GRILLOS™

USER FRIENDLY

COLOR	SIZE	CODE	G
BWO	16	72150	
	18	72151	
	20	72152	



BARR'S™

VIS-A-DUN

COLOR	SIZE	CODE	D
BAETIS	18	11636	
	20	11637	
	22	11638	
PMD	16	11639	
	18	11640	
TRICO	22	11645	
	24	11646	



WULFF

COLOR	SIZE	CODE	E
ROYAL	10	12226	
	12	12227	
	14	12228	
	16	12229	
	18	12230	
WHITE	10	12239	
	12	12240	



MATHEWS™

X-CADDIS

COLOR	SIZE	CODE	D
OLIVE	14	15769	
	16	15770	
	18	15771	
TAN	14	15772	
	16	15773	
	18	15774	



MATHEWS™

X2 CADDIS

COLOR	SIZE	CODE	D
OLIVE	14	16186	
	16	16187	
	18	16188	
TAN	14	16189	
	16	16190	
	18	16191	



SILVEY'S™

YELLOW SALLY

COLOR	SIZE	CODE	F
	14	SI60252	
	16	SI60253	



TERRESTRIALS



85

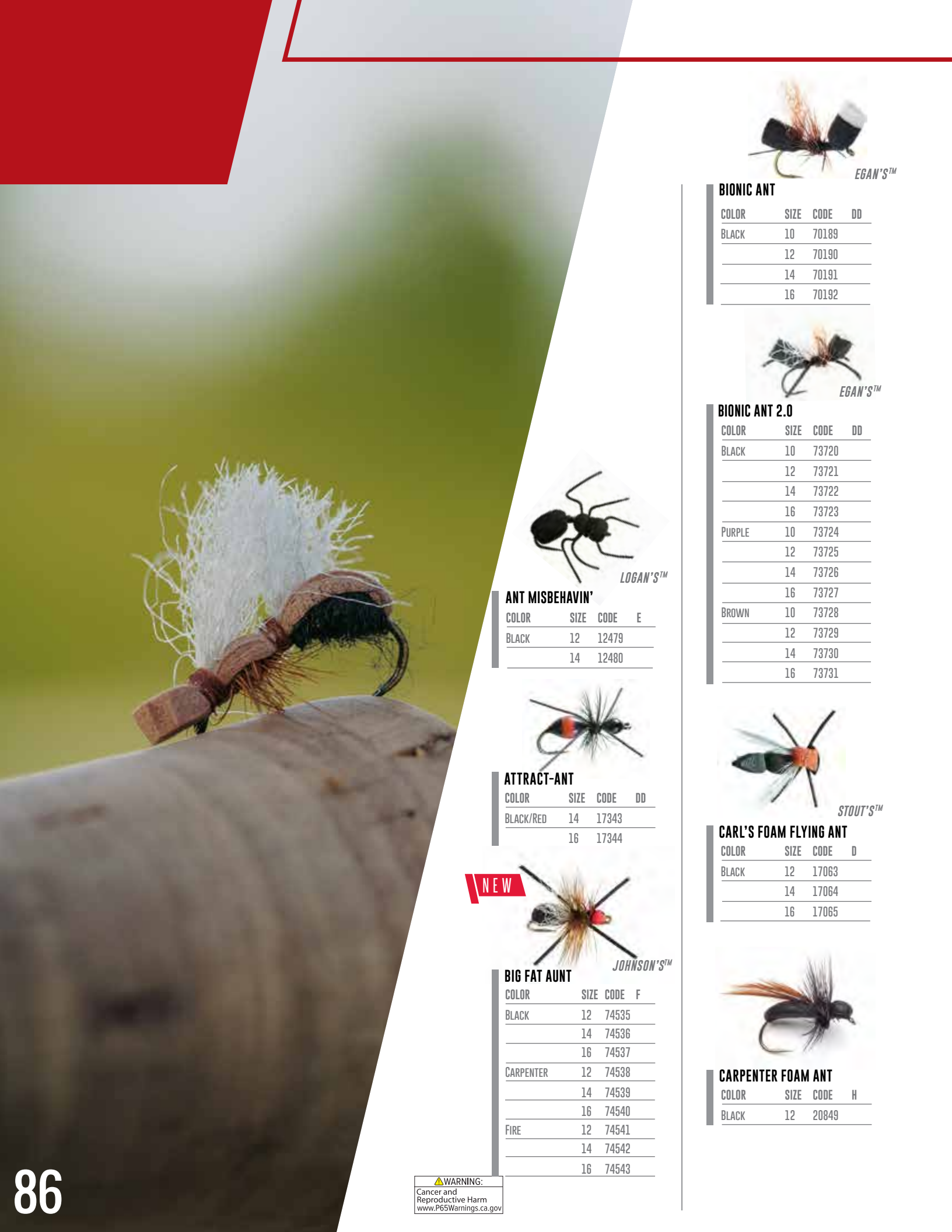

EGAN'S™

BIONIC ANT

COLOR	SIZE	CODE	DD
BLACK	10	70189	
	12	70190	
	14	70191	
	16	70192	



EGAN'S™

BIONIC ANT 2.0

COLOR	SIZE	CODE	DD
BLACK	10	73720	
	12	73721	
	14	73722	
	16	73723	
PURPLE	10	73724	
	12	73725	
	14	73726	
BROWN	16	73727	
	10	73728	
	12	73729	
	14	73730	
	16	73731	



LOGAN'S™

ANT MISBEHAVIN'

COLOR	SIZE	CODE	E
BLACK	12	12479	
	14	12480	



ATTRACT-ANT

COLOR	SIZE	CODE	DD
BLACK/RED	14	17343	
	16	17344	



STOUT'S™

CARL'S FOAM FLYING ANT

COLOR	SIZE	CODE	D
BLACK	12	17063	
	14	17064	
	16	17065	

NEW



JOHNSON'S™

BIG FAT AUNT

COLOR	SIZE	CODE	F
BLACK	12	74535	
	14	74536	
	16	74537	
CARPENTER	12	74538	
	14	74539	
	16	74540	
FIRE	12	74541	
	14	74542	
	16	74543	



CARPENTER FOAM ANT

COLOR	SIZE	CODE	H
BLACK	12	20849	

ANTS



SHIMAZAKI'S™

CDC ANT

COLOR	SIZE	CODE	D
BLACK	14	15716	
	16	15717	



CHERNOBYL ANT

COLOR	SIZE	CODE	DD
BLACK/TAN	8	17192	
	10	17193	



DAVIDSON'S™

CHUBBY CUBBY

COLOR	SIZE	CODE	D
BLACK	16	74635	
RED/BLACK	16	74636	
RED	16	74637	
BROWN	16	74756	



COW KILLER ANT

COLOR	SIZE	CODE	D
BLACK/RED	14	12139	
	16	12140	



DAVIDSON'S™

CUPBOARD ANT

COLOR	SIZE	CODE	DD
BLACK	16	73132	
BLACK/RED	16	73133	



DEER HAIR ANT

COLOR	SIZE	CODE	E
	12	TAB0040	
	14	TAB0041	
	16	TAB0042	



FLYING ANT

COLOR	SIZE	CODE	D
BLACK	12	16802	
	14	16803	
	16	16804	



SCHLOTTER'S™

FOAM FLYING ANT

COLOR	SIZE	CODE	E
BLACK	14	16988	
	16	16989	
	18	16990	
CINNAMON	14	16991	
	16	16992	
	18	16998	



FUR ANT

COLOR	SIZE	CODE	C
BLACK	12	16810	
	14	16811	
	16	16812	
	18	16813	



QUIGLEY'S™

GLITTER ANT FLAG

COLOR	SIZE	CODE	DD
BLACK	16	SIG1828	
	18	SIG1829	
CINNAMON	16	SIG1830	
	18	SIG1831	



SCHROEDER'S™

HI-VIS ANT

COLOR	SIZE	CODE	E
BLACK	14	16794	
	16	16795	
	18	16796	



HI-VIS FLYING ANT

COLOR	SIZE	CODE	DD
BLACK	14	SIG1279	
	18	SIG1280	
RUST/BLACK	14	SIG1283	
	18	SIG1284	



IWANE'S™

LAST GASP ANT

COLOR	SIZE	CODE	F
BLACK	14	74353	
	16	74354	
	18	74355	
RUST	14	74356	
	16	74357	
	18	74358	



MERCER'S™

MISSING LINK HONEY ANT

COLOR	SIZE	CODE	E
HONEY	14	73170	
	16	73171	



SCHROEDER'S™

PARACHUTE ANT

COLOR	SIZE	CODE	E
BLACK	14	12110	
	16	12111	
	18	12112	



TURCK'S™

POWER ANT

COLOR	SIZE	CODE	E
BLACK	11	16857	
	13	16858	
CINNAMON	13	16875	



FREED'S™

STUBBY ANT

COLOR	SIZE	CODE	DD
BLACK/CIN	12	74207	
	14	74208	
	16	74209	
RED/BLACK	12	74210	
	14	74211	
	16	74212	



TRANSPARENTS

COLOR	SIZE	CODE	DD
BLACK	14	17082	
	16	17083	
BLACK/RED	14	17085	
	16	17086	



COTTER'S™

TUNGSTEN DROWNED ANT

COLOR	SIZE	CODE	D
	14	19056	
	16	19057	
	18	19058	



HI-VIS FOAM BEETLE MIKE LAWSON

Many a day on the Henry's Fork and countless other rivers and streams have been saved by switching to a beetle when things get hot and tough.

This simple but effective imitation really gets it done. Try dropping an ant off the back to double your chances.

- Signature Tyer Mike Lawson



BLACK BEETLE

COLOR	SIZE	CODE	D
BLACK	14	16941	
	16	16942	



POTTER'S™

FATHEAD BEETLE

COLOR	SIZE	CODE	D
BLACK	12	17095	
	14	17098	
	16	17099	



POTTER'S™

FATHEAD BEETLE 2.0

COLOR	SIZE	CODE	D
	12	73847	
	14	73848	
	16	73849	



MURRAY'S™

FLYING BEETLE

COLOR	SIZE	CODE	D
BLACK	14	16993	
	16	16994	



FLYING LOCO BEETLE

COLOR	SIZE	CODE	F
	12	17091	
	14	17094	

BEETLES



LAWSON'S™

FOAM BEETLE

COLOR	SIZE	CODE	D
BLACK	14	17030	
	16	17031	



HORDOSKY'S™

MOHAWK BEETLE

COLOR	SIZE	CODE	DD
	10	71414	



GRILLOS'™

HAMBURGLER

COLOR	SIZE	CODE	F
BLACK	12	SIG2112	
	16	SIG2113	



YEAGER'S™

POINT GUARD BEETLE

COLOR	SIZE	CODE	E
BLACK	12	SIG2222	
	16	SIG2223	



LAWSON'S™

HI-VIS FOAM BEETLE

COLOR	SIZE	CODE	DD
BLACK	12	17114	
	14	17115	
	16	17116	

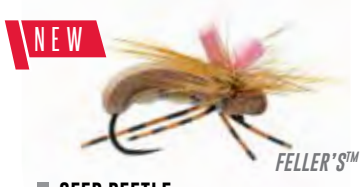

NEW

FELLER'S™

SEED BEETLE

COLOR	SIZE	CODE	F
BLACK	08	74268	
	10	74269	
	12	74270	
	14	74271	
BROWN	08	74272	
	10	74273	
	12	74274	
	14	74275	



JAPANESE BEETLE

COLOR	SIZE	CODE	D
BLACK/PEACOCK	12	17006	



DRUMMOND'S™

TIM'S BEETLE

COLOR	SIZE	CODE	F
GREEN	12	71420	
	16	71421	



MATHEWS'™

LONGHORN BEETLE

COLOR	SIZE	CODE	E
	10	19985	



DRUMMOND'S™

TIM'S BEETLE 2.0

COLOR	SIZE	CODE	F
GREEN	12	74217	
	16	74218	



FRESHWATER FLYS

LEADER & TIPPET

PACKS & BAGS

ACCESSORIES

HOOKS

TOOLS & KITS

TYING MATERIALS

NECKS & SADDLES



BARR/ CRAVEN'S™

B/C DROPPER HOPPER

COLOR	SIZE	CODE	G
TAN	6	16961	
	8	16962	
	10	16964	



CRAVEN'S™

BABY BOY HOPPER

COLOR	SIZE	CODE	G
OLIVE	12	17492	
	14	17493	
	16	17494	
TAN	12	17495	
	14	17496	
	16	17497	



LOGAN'S™

BIG SECRET CRICKET

COLOR	SIZE	CODE	I
BLACK	10	16905	



LOGAN'S™

BIG SECRET HOPPER

COLOR	SIZE	CODE	K
	8	19465	



CRAVEN'S™

BOY WONDER HOPPER

COLOR	SIZE	CODE	G
PEACH	08	73679	
	10	73680	
TAN	08	73681	
	10	73682	
YELLOW	08	73683	
	10	73684	



CRAVEN'S™

CHARLIE BOY HOPPER

COLOR	SIZE	CODE	E
TAN	8	16995	
	10	16996	
	12	16997	
YELLOW	10	17018	
	12	17019	



DAVE'S HOPPER

COLOR	SIZE	CODE	F
YELLOW	8	16931	
	10	16932	
	12	16933	
	14	16934	



PARAMORE'S™

FANCY PANTS HOPPER

COLOR	SIZE	CODE	I
GOLDENROD	8	74280	
	10	74281	
	12	74282	
	14	74283	
PINK	8	74284	
	10	74285	
	12	74286	
	14	74287	
PURPLE	8	74288	
	10	74289	
	12	74290	
	14	74291	
TAN	8	74292	
	10	74293	
	12	74294	
	14	74295	



FOAM HOPPER

COLOR	SIZE	CODE	F
BLACK	8	SIG2087	
	10	SIG2088	
	12	SIG2089	
	14	SIG2090	
BROWN	8	71753	
	10	71754	
	12	71755	
	14	71756	
GOLDEN	6	SIG1127	
	8	SIG1128	
	10	SIG1129	
	12	SIG1727	
	14	SIG1728	
GREEN	8	SIG1811	
	10	SIG1812	
	12	SIG1813	
	14	SIG1814	
PURPLE	8	71758	
	10	71759	
	12	71735	
	14	71736	
PINK	6	SIG1597	
	8	SIG1598	
	10	SIG1599	
	12	SIG1725	
	14	SIG1726	
TAN	6	SIG1130	
	8	SIG1131	
	10	SIG1132	
	12	SIG1723	
	14	SIG1724	



SMITHERMAN'S™

MASSHOPPER

COLOR	SIZE	CODE	H
TAN	8	72286	
	10	72287	
	12	73134	
	14	73895	
	16	73896	



JOHNSON'S™

MIMIC HOPPER

COLOR	SIZE	CODE	G
YELLOW	08	73250	
	10	73251	
	12	73252	



CRAVEN'S™

MORNINGWOOD HOPPER

COLOR	SIZE	CODE	G
PEACH	10	72293	
	12	72294	
YELLOW	10	72289	
	12	72290	



SCHROEDER'S™

PARACHUTE HOPPER

COLOR	SIZE	CODE	G
OLIVE	8	16911	
	10	16912	
	12	16913	
	14	16914	
TAN	8	16907	
	10	16908	
	12	16909	
	14	16910	



SMITHERMAN'S™

PINT HOPPER

COLOR	SIZE	CODE	F
YELLOW	12	74186	
	14	74187	
	16	74188	
TAN	12	74183	
	14	74184	
	16	74185	

HOPPERS & CRICKETS



NEAL'S™

SKOPPER

COLOR	SIZE	CODE	F
YELLOW	12	72210	
	14	72211	



MCKNIGHT'S™

SWEETGRASS HOPPER

COLOR	SIZE	CODE	I
TAN	8	12788	
	10	12789	
	12	12823	



TAKAHASHI'S™

TAKAHOOPER

COLOR	SIZE	CODE	G
GOLDEN	10	74228	
	12	74229	
	14	73925	
	16	73926	



PARAMORE'S™

THUNDER THIGHS HOPPER

COLOR	SIZE	CODE	H
BLACK	10	72307	
	12	72308	
	14	72309	
PINK	10	19763	
	12	19764	
	14	19765	
PURPLE	10	72304	
	12	72305	
	14	72306	
TAN	10	19767	
	12	19768	
	14	19769	
YELLOW	10	19771	
	12	19772	
	14	19773	

NEW



TOKACH'S™

TL HOPPER

COLOR	SIZE	CODE	K
BRN/CINN	06	74399	
	08	74400	
	10	74401	
GRY/PURP	06	74393	
	08	74394	
	10	74395	
ROYAL	06	74396	
	08	74397	
	10	74398	
TAN/YEL	06	74402	
	08	74403	
	10	74404	



MCKNIGHT'S™

THUNDER GRASS HOPPER

COLOR	SIZE	CODE	H
PEACH	08	73793	
	10	73794	
	12	73795	
	14	73796	
BLACK/ TAN	08	73797	
	10	73798	
	12	73799	
	14	73800	
TAN	08	73801	
	10	73802	
	12	73803	
	14	73804	
GOLDENROD	08	73805	
	10	73806	
	12	73807	
	14	73808	



THUNDER GRASS HOPPER DOUG MCKNIGHT

"I came up with the Thundergrass hopper as a follow up fly to my successful Sweetgrass hopper that Umpqua released a number of years ago.

The end goal was to come up with another extremely realistic hopper pattern that floats well, but also sits lower and is slurp-able and easy to feed a wised up fish.

I borrowed the legs from Eric Paramore's brilliant Thunder Thighs hopper, along with elements of the Sweetgrass along with a few new ideas- like the cylindrical body which makes a wonderfully realistic profile.

The Thundergrass also does not have any rubber to rot off if you don't use it for a while- always a pet peeve of myself and other anglers.

The fly is also very scalable down to the tiniest of sizes and it easy to control the proportions and keep them the same throughout the different sizes.

We also slipped in a TMC wet fly hook that will hold up to heavier tippets and also make the fly sit a bit lower in the column than many all-foam hoppers."

-Signature Tyer Doug McKnight

LEADER & TIPPET
PACKS & BAGS
ACCESSORIES
HOOKS
TOOLS & KITS
TYING MATERIALS
NECKS & SADDLES



YEAGER'S™

409

COLOR	SIZE	CODE	F
PURPLE	12	SIG2215	
	14	SIG2216	
	16	SIG2217	
YELLOW	12	SIG1204	
	14	SIG1205	
	16	SIG1722	



DENNIS™

AMY'S ANT

COLOR	SIZE	CODE	F
PURPLE	8	72010	
	10	72011	
	12	72012	
	14	72063	
OLIVE	8	17044	
	10	17041	
	12	19518	
	14	19519	
RED	8	17049	
	10	17046	
	12	19520	
	14	19521	



CRAVEN'S™

BIG FAT ANGIE

COLOR	SIZE	CODE	G
BLACK	08	73405	
	10	73406	
	12	73407	
	14	73469	
	16	73408	
GOLD	08	73408	
	10	73409	
	12	73410	
	14	73470	
	16	73471	
OLIVE	08	73412	
	10	73413	
	12	73414	
	14	73471	
	16	73415	
CINNAMON	08	73415	
	10	73416	
	12	73417	
	14	73472	
	16	73418	
PURPLE	08	73418	
	10	73419	
	12	73420	
	14	73473	



CHERNOBYL ANT

COLOR	SIZE	CODE	DD
BLACK/TAN	8	17192	
	10	17193	



CHUBBY CHERNOBYL

COLOR	SIZE	CODE	D
BLACK/ BLACK	08	73954	
	10	73955	
	12	73956	
	14	73957	
	16	73958	
BLACK/TAN	8	THP0112	
	10	THP0113	
	12	THP0114	
	14	THP0139	
	16	THP0140	
GOLD	8	THP0071	
	10	THP0072	
	12	THP0090	
	14	THP0141	
	16	THP0142	
OLIVE	8	THP0116	
	10	THP0117	
	12	THP0118	
	14	THP0143	
	16	THP0144	
ORANGE	8	THP0120	
	10	THP0095	
	12	THP0096	
	14	THP0145	
	16	THP0146	
UV CINNAMON	8	72240	
	10	72241	
	12	72242	
	14	72243	
	16	72244	
PINK	8	THP0122	
	10	THP0123	
	12	THP0124	
	14	THP0147	
	16	THP0148	
PTERONARCYS	6	THP0125	
	8	THP0126	
	10	THP0127	
	12	THP0128	
	14	THP0149	
16	THP0150		



SPILLERS™

BUMBLE BUTT BEE

COLOR	SIZE	CODE	F
BLACK	12	71640	



BOYLE'S™

CALEB'S BEE

COLOR	SIZE	CODE	G
	12	19059	



STOUT'S™

CARL'S CICADA

COLOR	SIZE	CODE	E
BLACK	8	17066	
	10	17067	

PURPLE	6	THP0129	
	8	THP0130	
	10	THP0131	
	12	THP0132	
	14	THP0137	
RED	16	THP0138	
	8	THP0068	
	10	THP0069	
	12	THP0091	
	14	THP0151	
ROYAL	16	THP0152	
	6	THP0133	
	8	THP0134	
	10	THP0135	
	12	THP0136	
ROYAL/ PURPLE	14	THP0153	
	16	THP0154	
	08	73960	
	10	73961	
	12	73962	
TAN	14	73963	
	16	73964	
	8	THP0098	
	10	THP0099	
	12	THP0100	
	14	THP0155	
	16	THP0156	



REID'S™

CLARK'S CICADA

COLOR	SIZE	CODE	I
OLIVE	10	17047	

OTHER TERRESTRIALS



Craven's™

FAT ANGIE

COLOR	SIZE	CODE	F
BLACK	14	73390	
	16	73391	
	18	73392	
GOLD	14	73393	
	16	73394	
	18	73395	
OLIVE	14	73396	
	16	73397	
	18	73398	
CINNAMON	14	73399	
	16	73400	
	18	73401	
PURPLE	14	73402	
	16	73403	
	18	73404	



POTTER'S™

FAT HEAD MOTH

COLOR	SIZE	CODE	E
TAN	12	70142	
	14	70143	



FLAT HEAD CICADA

COLOR	SIZE	CODE	E
	10	TAB0071	



Craven's™

JEFFREY DAUBER

COLOR	SIZE	CODE	F
BLACK	16	73666	



LOVEJOY'S™

LOVEJOY'S CICADA

COLOR	SIZE	CODE	G
	10	71921	



Craven's™

LUCKY B

COLOR	SIZE	CODE	F
BLACK/ YELLOW	16	73667	



SMITHERMAN'S™

MASSICADA

COLOR	SIZE	CODE	F
OLIVE/ WHITE	02	73902	
	04	73903	
ORANGE/ BLACK	02	73904	
	04	73905	

NEW



NAKED CHUBBY

COLOR	SIZE	CODE	DD
GOLDEN	06	74505	
	08	74506	
	10	74507	
	12	74508	
	14	74509	
	16	74510	
OLIVE	06	74529	
	08	74530	
	10	74531	
	12	74532	
	14	74533	
	16	74534	
ORANGE	06	74523	
	08	74524	
	10	74525	
	12	74526	
	14	74527	
	16	74528	

PURPLE	06	74499	
	08	74500	
	10	74501	
	12	74502	
	14	74503	
	16	74504	
ROYAL	06	74511	
	08	74512	
	10	74513	
	12	74514	
	14	74515	
	16	74516	
TAN	06	74517	
	08	74518	
	10	74519	
	12	74520	
	14	74521	
	16	74522	



Anderson's™

SPARKY'S FLOATING SPIDER

COLOR	SIZE	CODE	K
BLACK	10	19718	



SPONGE SPIDER

COLOR	SIZE	CODE	D
BLACK	12	16837	



STUBBY CHUBBY

COLOR	SIZE	CODE	DD
TAN LT	12	73990	
	14	73991	
	16	73992	
	18	73993	
BROWN/GOLD LT	12	73994	
	14	73995	
	16	73996	
	18	73997	
UV CINNAMON	12	72191	
	14	72192	
	16	72193	
	18	72194	
UV LIGHT YELLOW	12	72187	
	14	72188	
	16	72189	
	18	72190	
UV PURPLE	12	72195	
	14	72196	
	16	72197	
	18	72198	
UV TAN	12	72183	
	14	72184	
	16	72185	
	18	72186	



GRILLOS™

SUPERIOR SPRUCE MOTH

COLOR	SIZE	CODE	G
	12	72271	
	14	72272	



UMPQUA

6X FLY SIZE:
#16-22

DECEIVER
FLUOROCARBON

UMPQUA

7X FLY SIZE:
#20-24

DECEIVER X
FLUOROCARBON

2.5LB 1.1KG
50YD 45.7M
0.004" 10.10 mm

MIDGES & EMERGERS

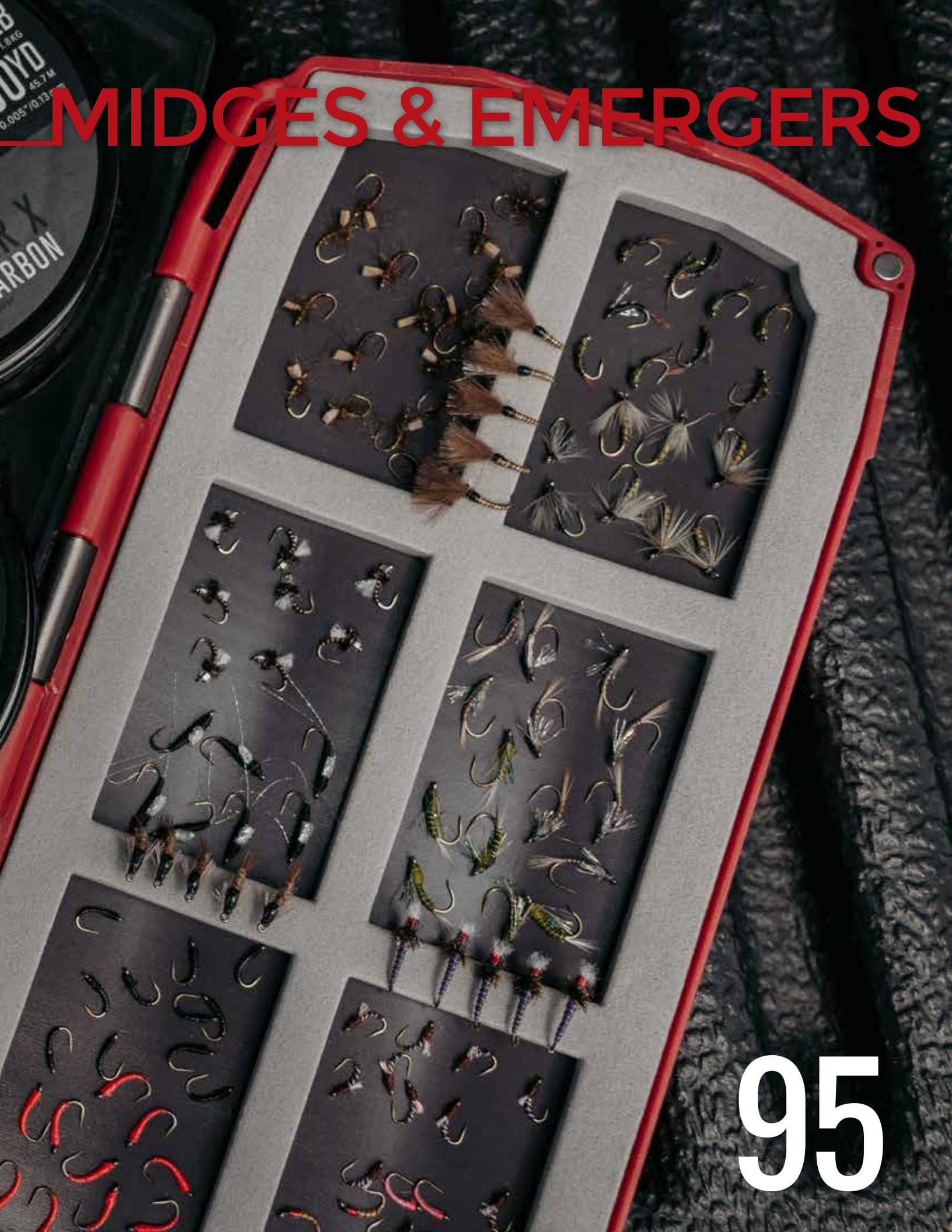

95



ADULT MIDGE

COLOR	SIZE	CODE	D
DARK	22	15567	



RODRIGUES'S™

ANTONIO'S QUILL MIDGE

COLOR	SIZE	CODE	D
HI VIS	18	73300	
	20	73301	
	22	73302	



RODRIGUES'S™

ANTONIO'S EMERGER

COLOR	SIZE	CODE	DD
BWO	16	73287	
	18	73288	
	20	73289	
MARCH BROWN	12	73293	
	14	73294	
PMD	16	73295	
	18	73296	



PETERSON'S™

BAT WING EMERGER BRASS BEAD

COLOR	SIZE	CODE	D
BWO	18	12612	
	20	12613	



BARR'S™

BEAD HEAD EMERGER BRASS BEAD

COLOR	SIZE	CODE	D
BWO	16	18768	
	18	18793	
	20	18794	
	22	18795	
PMD	16	18769	
	18	18790	
	20	18791	



BIOT MAYFLY EMERGER

COLOR	SIZE	CODE	D
BWO	18	18776	
	20	18777	
	22	18778	



BIOT MIDGE EMERGER

COLOR	SIZE	CODE	D
BLACK	18	18779	
	20	18780	
	22	18781	



BARR'S™

BLACK BACK EMERGER

COLOR	SIZE	CODE	E
	20	72502	
	22	72503	



DORSEY'S™

BLACK BEAUTY

COLOR	SIZE	CODE	A
	18	17267	
	20	17268	
	22	17269	
	24	17270	



DORSEY'S™

BLACK BEAUTY FLASHBACK

TUNGSTEN BEAD			
COLOR	SIZE	CODE	D
BLACK	18	19558	
	20	19559	
	22	19560	

NEW



EASDON'S™

BLINDSIDE MIDGE

COLOR	SIZE	CODE	F
BLACK	18	74565	
	20	74566	
	22	74567	
GRAY	18	74562	
	20	74563	
	22	74564	
PURPLE	18	74568	
	20	74569	
	22	74570	



LAWSON'S™

CADDIS EMERGER

COLOR	SIZE	CODE	D
OLIVE	14	18726	
	16	18727	
TAN	14	18729	
	16	18730	



CDC EMERGER

COLOR	SIZE	CODE	D
PINK	16	MCE009	
	18	MCE010	
PMD	16	MCE012	
	18	MCE013	



CDC GREEN DRAKE EMERGER

COLOR	SIZE	CODE	E
BIOT BODY	12	18582	



CHALLENGED

COLOR	SIZE	CODE	D
PMD	16	MCH0021	
	18	MCH0022	



BRASS BEAD TMC 2302

CHIRONOMID BOMBER

COLOR	SIZE	CODE	C
BLACK/RED	10	11791	
	12	11792	
	14	11793	
BLACK/SILVER	10	11794	
	12	11795	
	14	11796	



BRASS BEAD TMC 2457

CHIRONOMID PUPA

COLOR	SIZE	CODE	C
BLACK/RED	12	11807	
	14	11808	
	16	11809	

MIDGES & EMERGERS



CHROME CHIRONOMID BRASS BEAD

COLOR	SIZE	CODE	C
	12	MDE0063	
	14	MDE0064	



BARR'S™

DARK BACK EMERGER

COLOR	SIZE	CODE	D
	16	72275	
	18	72276	



QUIGLEY'S™

CLUSTER

COLOR	SIZE	CODE	E
PEACOCK	16	SIG2200	
	20	SIG1819	



MCCANNEL'S™

DEMON MIDGE

COLOR	SIZE	CODE	DD
RED	18	72527	
	20	72528	
	22	72529	



LAWSON'S™

CRIPPLE DUN

COLOR	SIZE	CODE	DD
PMD	16	18713	
	18	18714	



GOMEZ'S™

DESERT STORM GLASS BEAD

COLOR	SIZE	CODE	B
FLOURESCENT ORANGE	20	14743	
	22	14744	



THURMAN'S™

CUT BAIT MIDGE BRASS BEAD

COLOR	SIZE	CODE	C
RED	10	71363	
	12	71364	



DISCO MIDGE

COLOR	SIZE	CODE	A
RED	20	17996	
	22	17997	
	24	17998	



D. MILLERS™

D-MIDGE GLASS BEAD

COLOR	SIZE	CODE	D
GRAY	18	18921	
	20	18923	
PURPLE	18	18926	
	20	18927	
RED	18	18928	
	20	18929	



BARR'S™

EMERGER WET

COLOR	SIZE	CODE	D
BWO	16	18543	
	18	18544	
	20	18545	
	22	18546	
PMD	16	18539	
	18	18540	
	20	18541	

NEW



DAVIDSON'S™



CRAVEN'S™



FROSTBITE CHIRONOMID BRASS BEAD

COLOR	SIZE	CODE	C
RED W/COPPER BEAD	12	18762	
	14	18763	
	16	18764	

JUJUBEE MIDGE

COLOR	SIZE	CODE	C
BLUE	18	10427	
	20	10428	
	22	10441	
BROWN	18	10442	
	20	10444	
	22	10445	
OLIVE	18	17247	
	20	17240	
	22	17241	
RED	18	17258	
	20	17259	
	22	17265	
ZEBRA	18	17248	
	20	17249	
	22	17253	

LED MIDGE

COLOR	SIZE	CODE	E
CHOCOLATE	16	74612	
	18	74613	
	20	74614	
	22	74615	
RED	16	74627	
	18	74628	
	20	74629	
	22	74630	
UV BLUE	16	74631	
	18	74622	
	20	74623	
	22	74624	
UV CREAM	16	74625	
	18	74626	
	20	74627	
	22	74628	
UV FUCSHIA	16	74607	
	18	74608	
	20	74609	
	22	74610	
	24	74611	
	16	74617	
	18	74618	
	20	74619	
	22	74620	
	24	74621	



PETTINE'S™

ERIC'S MIDGE HI-VIS

COLOR	SIZE	CODE	D
DARK	20	17296	
	22	17297	



LAWSON'S™

HALFBACK EMERGER

COLOR	SIZE	CODE	DD
PMD	16	18723	
	18	18724	



ICE CREAM CONE BRASS BEAD

COLOR	SIZE	CODE	C
BLACK	12	MDE0069	
	14	MDE0070	
	16	MDE0081	
BRIGHT RED	10	MDE0093	
	12	MDE0094	
	14	MDE0095	
	16	MDE0096	



CRAVEN'S™

JUJUBEE MIDGE FLASH

COLOR	SIZE	CODE	C
RED	18	70765	
	20	70766	
	22	70767	
ZEBRA	18	70768	
	20	70769	
	22	70770	



QUIGLEY'S™

FILM CRITIC

COLOR	SIZE	CODE	E
BWO	16	SIG1629	
	18	SIG1630	
	20	SIG1631	
CALLIBAETIS	14	SIG1632	
	16	SIG1633	
FLAV	14	SIG1634	
GREEN DRAKE	10	SIG1635	
	12	SIG1636	
GRAY DRAKE	10	SIG1820	
	12	SIG1821	
PINK	16	SIG1637	
	18	SIG1638	
PMD	16	SIG1639	
	18	SIG1640	



THOMPSON'S™

LIL FOAMY TUNGSTEN BEAD

COLOR	SIZE	CODE	E
PURPLE	18	71588	
	20	71589	



BARR'S™

FLASHBACK EMERGER

COLOR	SIZE	CODE	D
BWO	16	17154	
	18	17155	
	20	17156	
	22	17157	
PMD	16	17159	
	18	17160	
	20	17161	



MAKTIMA'S™

ICU MIDGE TUNGSTEN BEAD

COLOR	SIZE	CODE	DD
RED	16	10731	
	18	10732	



CRAVEN'S™

JUMBO JUJU CHIRONOMID BRASS BEAD

COLOR	SIZE	CODE	E
BLOOD	12	17535	
	14	17536	
	16	17537	
OLIVE	12	17538	
	14	17539	
	16	17540	
ZEBRA	12	17541	
	14	17542	
	16	17543	



CHOVINARD'S™

IMPROVED PHEASANT TAIL

COLOR	SIZE	CODE	D
	12	70898	
	14	70899	
	16	70900	

MIDGES & EMERGERS



PASSAGE'S™

MAGIC FLY TUNGSTEN BEAD

COLOR	SIZE	CODE	DD
BWO	18	70077	
	20	70078	
	22	70079	
PMD	16	70084	
	18	70085	
RUSTY	16	70081	
	18	70082	



PASSAGE'S™

MAGIC FLY

COLOR	SIZE	CODE	C
PMD	18	70092	
	20	70093	



MALDONADO'S™

MALDO'S EMERGER

COLOR	SIZE	CODE	DD
PMD	16	73233	
	18	73234	



MALDONADO'S™

MALDO'S TRICO

COLOR	SIZE	CODE	DD
TRICO	20	73231	
	22	73232	



DORSEY'S™

MANHATTAN MIDGE

COLOR	SIZE	CODE	D
BLACK	18	72344	
	20	72345	
	22	72346	
BROWN	18	72341	
	20	72342	
	22	72343	
PURPLE	18	73708	
	20	73709	
	22	73710	
RED	18	72338	
	20	72339	
	22	72340	



MCCANNEL'S™

MASSACRE MIDGE

COLOR	SIZE	CODE	D
BLACK	18	73789	
	20	73790	
	22	73791	
	24	73792	
BROWN	18	72326	
	20	72327	
	22	72328	
	24	72329	
LIGHT OLIVE	18	72330	
	20	72331	
	22	72332	
	24	72333	



DORSEY'S™

MEDALLION MIDGE PUPA

COLOR	SIZE	CODE	C
	20	12817	
	22	12818	
	24	12819	



DORSEY'S™

MERCURY SERIES GLASS BEAD

COLOR	SIZE	CODE
BAETIS	18	14370 C
	20	14371
	22	14372
	24	14380
BLACK BEAUTY	18	14431 B
	20	14432
	22	14433
BLACK BEAUTY FLASHBACK	18	15907 B
	20	15908
FLASHBACK PHEASANT TAIL	16	14416 D
	18	14417
	20	14418
	22	14419
MIDGE/ GRAY	18	14488 B
	20	14489
	22	14490
RS-2 FLASHBACK/GRAY	18	12776 C
	20	12777
	22	12778
	24	12779
RS-2/ GRAY	18	14522 C
	20	14523
	22	14524
	24	14411



MCCANNEL'S™

MIGHTY MIDGE

COLOR	SIZE	CODE	DD
RED	18	72530	
	20	72531	
	22	72532	
	24	72533	
BLUE	18	72534	
	20	72535	
	22	72536	
	24	72537	



CRAVEN'S™

MOLE FLY

COLOR	SIZE	CODE	D
BROWN	18	70216	
	20	70217	
	22	70218	
	24	70219	
PMD	16	70856	
	18	70857	
OLIVE	18	70859	
	20	70860	
	22	70861	
	24	70862	



CRAVEN'S™

MOLE MIDGE

COLOR	SIZE	CODE	E
NATURAL	18	72523	
	20	72524	
	22	72525	



MORGAN/LARSON'S™

MORGAN'S MIDGE

COLOR	SIZE	CODE	DD
DARK	20	11295	
	22	11296	
	24	11297	



MORGAN/LARSON'S™

MORGAN'S PARA MIDGE

COLOR	SIZE	CODE	E
CHARCOAL	20	13457	
	22	13458	

NEW



DORSEY'S™

PAT'S MIDGE

COLOR	SIZE	CODE	E
	18	74550	
	20	74551	
	22	74552	
	24	74553	



MERCER'S™

POXYBACK EMERGER

COLOR	SIZE	CODE	J
HEXAGENIA	6	14825	



BARR'S™

PURE MIDGE LARVA

COLOR	SIZE	CODE	C
BLACK	20	11346	
	22	11347	
FIRE RED	18	11298	
	20	11299	
	22	11300	



BLESSING'S™

PURPLE HAZE EMERGER

COLOR	SIZE	CODE	D
	16	74094	
	18	74225	
	20	74226	
	22	74227	



GARCIA'S™

**ROJO MIDGE
GLASS BEAD**

COLOR	SIZE	CODE	D
BLACK	20	11465	
	22	11466	
HOT RED	18	11667	
	20	11668	
	22	11669	
PURPLE	20	73086	
	22	73087	

ROY'S SPECIAL EMERGER

COLOR	SIZE	CODE	C
GRAY	18	74006	
	20	18772	
	22	18773	



RS2 EMERGER

COLOR	SIZE	CODE	B
BLACK	18	11260	
	20	11261	
	22	11262	
	24	11263	
DUN	18	11241	
	20	11242	
	22	11243	
	24	11244	
OLIVE	18	11248	
	20	11249	
	22	11250	
	24	11251	



RS2 SPARKLE WING

COLOR	SIZE	CODE	C
BLACK	18	19611	
	20	19612	
	22	19613	
GRAY	18	11387	
	20	11388	
	22	11389	
OLIVE	18	19614	
	20	19615	
	22	19616	
PURPLE	18	72504	
	20	72505	
	22	72506	

**RS2 SPARKLE WING RADIANT
TUNGSTEN BEAD**

COLOR	SIZE	CODE	E
BLACK	18	72872	
	20	72873	
	22	72874	
GRAY	18	72875	
	20	72876	
	22	72877	
OLIVE	18	72878	
	20	72879	
	22	72880	
PURPLE	18	72881	
	20	72882	
	22	72883	



MATHEWS'™

SKITTERING ZELON MIDGE

COLOR	SIZE	CODE	C
	20	19712	



CRAVEN'S™

SOFT HACKLE EMERGER

COLOR	SIZE	CODE	D
GRAY	18	11224	
	20	11229	
	22	11230	



QUIGLEY'S™

SPLIT FLAG

COLOR	SIZE	CODE	E
ADAMS	10	SIG1679	
	12	SIG1147	
	14	SIG1148	
	16	SIG1149	
	18	SIG1150	
PMD	16	SIG0915	
	18	SIG0916	



MCCANNEL'S™

NEON NIGHTMARE

COLOR	SIZE	CODE	C
FLouRESCENT ORANGE	18	71740	
	20	71741	
	22	71742	
FLouRESCENT PINK	18	71743	
	20	71744	
	22	71745	



IWANE'S™

NO MERCY MIDGE

COLOR	SIZE	CODE	D
CAMEL	18	72347	
	20	72348	
	22	72349	
	24	74093	
BLACK	18	74359	
	20	74360	
	22	74361	
	24	74362	
CREAM	18	74363	
	20	74364	
	22	74365	
	24	74366	



BEFUS'™

PARA EMERGER

COLOR	SIZE	CODE	D
BWO	18	11590	
	20	11591	
	22	11592	

MIDGES & EMERGERS



TAKAHASHI'S™

TAK'S CHRYSTAL CHIRONOMID

COLOR	SIZE	CODE	E
	12	19473	
	14	19474	



MAYER'S™

TITAN TUBE MIDGE BRASS BEAD

COLOR	SIZE	CODE	D
BLACK/RED	12	71148	
	14	71149	
	16	71150	
BLACK/SILVER	12	71151	
	14	71152	
	16	71153	



DORSEY'S™

TOP SECRET MIDGE

COLOR	SIZE	CODE	C
	20	11391	
	22	11393	
	24	11394	
PURPLE	20	74100	
	22	74101	
	24	74102	



TRAILING SHUCK MIDGE

COLOR	SIZE	CODE	DD
DARK	20	16099	
	22	16100	



TUNGSTEN ZEBRA MIDGE TUNGSTEN BEAD

COLOR	SIZE	CODE	D
BLACK	14	70609	
	16	11918	
	18	11919	
	20	11920	
	22	70610	
BLACK/COPPER	16	11746	
	18	11747	
	20	11748	
OLIVE	16	11823	
	18	11824	
	20	11825	
PURPLE	16	72496	
	18	72497	
	20	72498	
RED	16	11895	
	18	11896	
	20	11897	
RUSTY BROWN	16	11921	
	18	11922	
	20	11923	



TUNGSTEN ZEBRA MIDGE THIN TUNGSTEN BEAD

COLOR	SIZE	CODE	D
BLACK	16	71315	
	18	71316	
	20	71317	
	22	71318	
OLIVE	18	71324	
	20	71325	
	22	71326	
RED	18	71320	
	20	71321	
	22	71322	
RUST	18	71328	
	20	71329	
	22	71330	
PURPLE	18	72493	
	20	72494	
	22	72495	



CADY'S™

TUNGSTEN ZEBRA TWO-TONE

COLOR	SIZE	CODE	DD
BLACK/RED	16	19234	
	18	19235	
	20	19236	



CRAVEN'S

TWO BIT MIDGE

COLOR	SIZE	CODE	E
BLUE	18	72369	
	20	72369	
	22	72370	
BROWN	18	72359	
	20	72360	
	22	72361	
OLIVE	18	72362	
	20	72363	
	22	72364	
RED	18	72365	
	20	72366	
	22	72367	



ENGLER'S™

WD-40

COLOR	SIZE	CODE	B
BLACK	18	12662	
	20	12663	
	22	12664	
	24	12665	
CHOCOLATE	18	12656	
	20	12657	
	22	12658	
	24	12659	
GRAY	18	13832	
	20	13833	
	22	13834	
	24	13835	
OLIVE	18	12650	
	20	12651	
	22	12652	
	24	12653	



STOUT'S™

WD-50

COLOR	SIZE	CODE	B
GRAY	18	12682	
	20	12683	
OLIVE	18	12686	
	20	12687	



KINGREY'S™

WILD TURKEY BAETIS

COLOR	SIZE	CODE	E
	20	SIG0602	
	22	SIG0603	



MATHEWS™

ZELON MIDGE IMPROVED

COLOR	SIZE	CODE	C
	18	73780	
	20	73781	
	22	73782	
	24	73783	

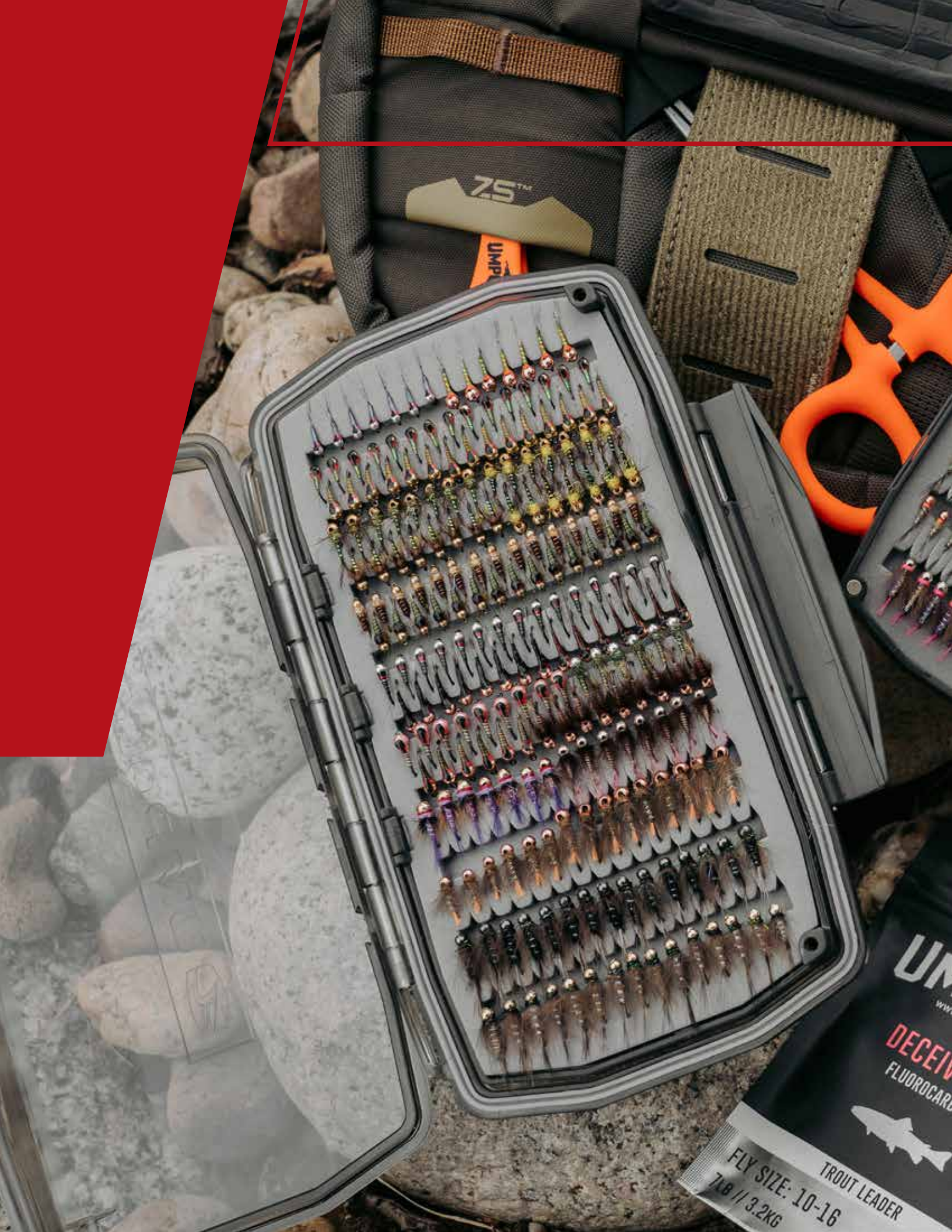

75™

UMP

UM

DECEIV
FLUOROCARB



FLY SIZE: 10-16
TROUT LEADER
7lb // 3.2kg

NYMPHS & WET FLIES



103



20 INCHER

COLOR	SIZE	CODE	D
	8	12331	
	10	12332	
	12	12333	



20 INCHER TUNGSTEN BEAD

COLOR	SIZE	CODE	E
PEACOCK	10	17936	
	12	17937	
	14	17938	



20 INCHER JIGGED TUNGSTEN BEAD

COLOR	SIZE	CODE	G
	8	10706	
	10	10707	
	12	10708	
	14	10709	



ANATO-MAY BRASS BEAD

COLOR	SIZE	CODE	E
HARE'S EAR	14	SIG0091	
	16	SIG0092	
OLIVE	14	SIG0096	
	16	SIG0097	
	18	SIG0290	



NEWMAN'S™

ANTIFREEZE CADDIS

COLOR	SIZE	CODE	E
OLIVE/BLACK	12	73835	
	14	73836	
	16	73837	
CREAM	12	73838	
	14	73839	
	16	73840	
LIME	12	73841	
	14	73842	
	16	73843	



HUDSPETH'S™

ATOMIC STONE TUNGSTEN BEAD

COLOR	SIZE	CODE	I
BROWN/BLACK	6	70927	



BARR'S™

BARR'S™ UNCASED CADDIS TUNGSTEN BEAD

COLOR	SIZE	CODE	F
GREEN	14	10931	
	16	10932	

NEW



BAXTER'S™

BEARDED BAETIS

COLOR	SIZE	CODE	K
OLIVE	16	74264	
	18	74265	
PURPLE	16	74266	
	18	74267	



ANDREWS'™

BEAR'S SADDLEBACK HEX

COLOR	SIZE	CODE	F
YELLOW	6	17871	



MERCER'S™

BIOT EPOXY STONE NYMPH BRASS BEAD

COLOR	SIZE	CODE	E
DARK	8	15053	
	10	15055	
	12	15057	
GOLD	8	15066	
	10	15047	
	12	15048	
	14	15049	



MERCER'S™

BIOT EPOXY STONE JIG TUNGSTEN BEAD

COLOR	SIZE	CODE	H
DARK	10	72802	
	12	72803	
GOLD	10	72804	
	12	72805	
	14	72806	



BIRD'S NEST

COLOR	SIZE	CODE	C
NATURAL	14	NSN0034	
	16	NSN0035	



BIRD'S NEST BRASS BEAD

COLOR	SIZE	CODE	D
NATURAL	14	NSN0681	
	16	NSN0682	



BISHOP'S™

BISHOP'S™ DYNAMITE

COLOR	SIZE	CODE	E
BROWN/ORANGE	14	19659	
	16	19660	
	18	19661	



VANDEHEY'S™

BIZZARD JERRY

COLOR	SIZE	CODE	E
	12	74124	

NEW



SEXTON'S™

BLACK VELVET

COLOR	SIZE	CODE	F
	12	74125	
	14	74126	
	16	74127	
	18	74128	



OLSEN'S™

BLOWTORCH TUNGSTEN BEAD

COLOR	SIZE	CODE	G
UV PURPLE	10	72575	
	12	72576	
	14	72577	
	16	72578	
BLACK	10	72579	
	12	72580	
	14	72581	
	16	72582	
HARE'S EAR	10	73178	
	12	73179	
	14	73180	
	16	73181	

LYMPHS & WET FLIES



BRASSIE

COLOR	SIZE	CODE	B
COPPER	18	13886	
	20	13887	



DORSEY'S™

BREADCRUST JIG

COLOR	SIZE	CODE	F
NATURAL	10	73703	
	12	73704	
	14	73705	
	16	73706	
OLIVE	10	74040	
	12	74041	
	14	74042	
	16	74043	

NEW



SCHROEDER'S™

BUBBA'S CALLIBAETIS NYMPH

COLOR	SIZE	CODE	DD
	14	19552	
	16	19553	



BUCKSKIN CADDIS

COLOR	SIZE	CODE	C
	14	13878	
	16	13879	
	18	13880	



CBD NYMPH JIG

COLOR	SIZE	CODE	G
BLACK	16	72451	
	18	72452	
LEATHER	16	72445	
	18	72446	
OLIVE	16	72448	
	18	72449	



PHARES'™

CADDIS CANDY

COLOR	SIZE	CODE	DD
LIME	16	18934	
	18	18935	



CADDIS LARVA

COLOR	SIZE	CODE	C
OLIVE	14	18271	
	16	18272	



CADDIS LARVA BH BRASS BEAD

COLOR	SIZE	CODE	B
BRIGHT GREEN	14	NSN0047	
	16	NSN0048	
	18	NSN0049	



FOX'S™

CADDIS POOPAH

COLOR	SIZE	CODE	DD
OLIVE	12	13917	
	14	13918	
	16	13919	
TAN	12	13923	
	14	13921	
	16	13922	



FOX'S™

CADDIS POOPAH BRASS BEAD

COLOR	SIZE	CODE	DD
OLIVE	12	14017	
	14	14018	
	16	14019	
TAN	12	14014	
	14	14015	
	16	14016	

NEW



DORSEY'S™

BUCKSKIN JIG

COLOR	SIZE	CODE	E
	14	74429	
	16	74430	
	18	74431	

WG Flies have weed guards. HCB Flies are packaged with a header card. Price codes accompanied by (*) indicate a quantity of 5. Colors in bold/italic indicate which color is shown. PRICE CODES A*\$12.60 B*\$15.00 C*\$17.70 D*\$20.10 DD*\$22.50 E*\$24.00 F*\$27.00 G*\$29.70 H*\$33.30 I*\$37.50 J*\$42.00 K*\$48.00 KK*\$57.00 L*\$70.50 M*\$79.50

FRESHWATER FLYS

LEADER & TIPPET

ACCESSORIES

PACKS & BAGS

HOOKS

TOOLS & KITS

TYING MATERIALS

NECKS & SADDLES



**CADDISTROPHIC PUPA
TUNGSTEN BEAD**

COLOR	SIZE	CODE	E
CREAM	16	70033	
OLIVE	16	70036	



CALLIBAETIS NYMPH

COLOR	SIZE	CODE	D
	14	14001	
	16	14002	



**CALLIBAETIS NYMPH CDC
BRASS BEAD**

COLOR	SIZE	CODE	F
OLIVE	14	19329	
	16	19330	
TAN	14	19331	

NEW



CDC CASED CADDIS JIG

COLOR	SIZE	CODE	G
	14	74560	
	16	74561	



CDC STONE

COLOR	SIZE	CODE	F
DARK	06	73655	
	08	73656	
	10	73657	
	12	73658	
GOLDEN	08	73659	
	10	73660	
	12	73661	
	14	73662	



**COPPER JOHN
BRASS BEAD**

COLOR	SIZE	CODE	D	
GOLD BEAD/PHEASANT TAIL	14	71771		
	16	71772		
	18	71773		
GOLD BEAD/BLACK	12	13568		
	14	13569		
	16	13570		
	18	13571		
GOLD BEAD/CHARTREUSE	12	14375		
	14	14376		
	16	14377		
	18	14378		
GOLD BEAD/COPPER	12	14095		
	14	14096		
	16	14097		
	18	14098		
	20	13575		
	GOLD BEAD/GREEN	12	14048	
		14	14049	
16		14050		
	18	14051		
	GOLD BEAD/RED	12	14099	
		14	14100	
16		14101		
	18	14102		
	20	13581		
SILVER BEAD/ZEBRA	12	13430		
	14	13431		
	16	13432		
	18	13433		
	20	13434		



COPPER JOHN JIG

COLOR	SIZE	CODE	G
COPPER	12	72816	
	14	72817	
	16	72818	
RED	12	72819	
	14	72820	
	16	72821	



**CRACK BACK
TUNGSTEN BEAD**

COLOR	SIZE	CODE	F
PMD	14	SIG1693	
	16	SIG1694	
	18	SIG1695	



CRANE FLY LARVA

COLOR	SIZE	CODE	E
OLIVE	8	10644	



CREEK CRAWLER

COLOR	SIZE	CODE	I
DIRTY ORANGE	4	10715	
OLIVE	4	10716	
TAN	4	10717	



**CRYSTAL HUNCHBACK
BRASS BEAD**

COLOR	SIZE	CODE	D
PMD	16	13956	
	18	13957	



**CRYSTAL HUNCHBACK
TUNGSTEN BEAD**

COLOR	SIZE	CODE	E
BAETIS	18	14859	
	20	14860	
PMD	16	14864	
	18	14867	



**CUT BAIT MIDGE
BRASS BEAD**

COLOR	SIZE	CODE	C
RED	10	71363	
	12	71364	



**CZ CADDIS TUNGSTEN
TUNGSTEN BEAD**

COLOR	SIZE	CODE	G
CREAM	10	18888	
	12	18889	
OLIVE	10	18890	
	12	18891	



CZECH BOMB

COLOR	SIZE	CODE	F
OLIVE 2.5MM	16	73331	
	18	73332	
OLIVE 3.0MM	14	73333	
	16	73334	
OLIVE 3.5MM	14	73335	
	16	73336	
BROWN 2.5MM	16	73337	
	18	73338	
BROWN 3.0MM	14	73339	
	16	73340	
BROWN 3.5MM	14	73341	
	18	73342	
BLACK 2.5MM	16	73343	
	18	73344	
BLACK 3.0MM	14	73345	
	16	73346	
BLACK 3.5MM	14	73347	
	16	73348	

NYMPHS & WET FLIES



D. MILLER'S™

D-MIDGE GLASS BEAD

COLOR	SIZE	CODE	D
GRAY	18	18921	
	20	18923	
PURPLE	18	18926	
	20	18927	
RED	18	18928	
	20	18929	



GARCIA'S™

DARTH BAETIS

COLOR	SIZE	CODE	DD
GRAY	18	71177	
	20	71178	
	22	71179	
OLIVE	18	71181	
	20	71182	
	22	71183	
READHAD	18	70985	
	20	70986	
	22	70987	
PURPLE	18	72644	
	20	72645	
	22	72646	



HADDON'S™

DEAD DRIFT CRAYFISH

COLOR	SIZE	CODE	H
BROWN	8	11688	
OLIVE	8	11689	



BOND'S

DEEP CLEANER

COLOR	SIZE	CODE	G
COFFEE/ BLACK	4	72371	
	6	72372	
	8	72373	
GOLD STONE	6	72374	
	8	72375	
	10	72376	



DEEP OCTOBER PUPA BRASS BEAD

COLOR	SIZE	CODE	G
	6	SIG0025	
	8	SIG0026	



PARROTT'S™

DEVIL JIG JIGGED TUNGSTEN BEAD

COLOR	SIZE	CODE	F
BLUE	14	70223	
	16	70224	
COPPER	14	70461	
	16	70462	
GOLD	14	70226	
	16	70227	
GREEN	14	70229	
	16	70230	
RED	14	70464	
	16	70465	



OLSEN'S™

DIABAETIS PERDIGON

COLOR	SIZE	CODE	F
BLACK	14	74129	
	16	74130	
	18	74131	
	20	74132	
OLIVE	14	74133	
	16	74134	
	18	74135	
	20	74136	



DIRTY BIRD BRASS BEAD

COLOR	SIZE	CODE	E
HARE'S EAR	14	SIG0031	
	16	SIG0032	
OLIVE	14	SIG0037	
	16	SIG0038	



DIRTY BIRD TUNGSTEN BEAD

COLOR	SIZE	CODE	G
HARE'S EAR	12	SIG1450	
	14	SIG1451	
	16	SIG1452	
OLIVE	14	SIG1453	
	16	SIG1454	



DURACELL BOMB

COLOR	SIZE	CODE	F
BROWN 2.5MM	16	73318	
	18	73319	
	16	73320	
BROWN 3.0MM	14	73320	
	16	73321	
	12	73465	
BROWN 3.5MM	14	73322	
	12	73466	
BROWN 4.0MM	16	74047	
	18	74048	
OLIVE 2.5	14	74049	
	16	74050	
	12	74051	
OLIVE 3.0	14	74052	
	12	74053	
OLIVE 3.5	12	74054	
	18	74055	
PT 2.5	14	74056	
	16	74057	
PT 3.0	12	74058	
	14	74059	
PT 3.5	12	74060	
	16	74061	
UV BLACK 2.5	16	74062	
	14	74063	
UV BLACK 3.0	16	74064	
	12	74065	
UV BLACK 3.5	14	74066	
	12	74067	
UV BLACK 4.0	16	74068	
	18	74069	
UV HE 2.5	14	74070	
	16	74071	
UV HE 3.0	12	74072	
	14	74073	
UV HE 3.5	12	74074	



LAWSON'S™

ELECTRIC CADDIS

COLOR	SIZE	CODE	DD
OLIVE	14	18718	
	16	18719	



LAWSON'S™

ELECTRIC CADDIS TUNGSTEN BEAD

COLOR	SIZE	CODE	E
OLIVE	14	12257	
	16	12258	
	18	12259	



PARROTT'S™

EURO JIG NYMPH JIGGED TUNGSTEN BEAD

COLOR	SIZE	CODE	F
BROWN/PALE YELLOW	14	19951	
	16	19952	
BROWN	14	19948	
	16	19949	
OLIVE FLASH	14	19954	
	16	19955	

NEW



DOCTOR'S™

FLEXY STONE

COLOR	SIZE	CODE	F
BLACK	04	74662	
	06	74663	
	08	74664	
GOLDEN	04	74665	
	06	74666	
	08	74667	

NEW



GRAFFAM'S™

GOLDEN NUGGET

COLOR	SIZE	CODE	G
BLACK	14	74298	
	16	74299	
	18	74300	
GOLDEN	12	74301	
	14	74302	
	16	74303	



HELGRAMITE

COLOR	SIZE	CODE	G
	8	14039	



BURK'S™

HUNCHBACK GREEN DRAKE TUNGSTEN BEAD

COLOR	SIZE	CODE	H
OLIVE	10	14879	



EGAN'S™

FRENCHIE TUNGSTEN BEAD

COLOR	SIZE	CODE	E
PHEASANT TAIL	12	12912	
	14	12913	
	16	12914	
	18	12915	



EGAN'S™

FRENCHIE JIG TUNGSTEN BEAD

COLOR	SIZE	CODE	F
	12	72822	
	14	72823	
	16	72824	



BARR'S™

GRAPHIC CADDIS

COLOR	SIZE	CODE	D
OLIVE	14	12206	
	16	12207	
	18	12208	
TAN	14	12210	
	16	12211	
	18	12212	



MCCANNEL'S™

HELL RAZOR CRAW JIGGED

COLOR	SIZE	CODE	J
NATURAL GRAY	12	71715	
ORANGE	12	71716	



MCCANNEL'S™

HELL RAZOR LEECH

COLOR	SIZE	CODE	J
BLACK	12	71720	
NATURAL GRAY	12	71721	
OLIVE	12	71722	



BURK'S™

HEXAGENIA

COLOR	SIZE	CODE	G
YELLOW	6	14593	



BURK'S™

HUNCHBACK TWO-TONE

COLOR	SIZE	CODE	D
BROWN/SULFUR	16	14873	
	18	14874	



GRAFFAM'S™

HUSTLER CDC

COLOR	SIZE	CODE	F
LIGHT 2.5	16	73308	
	18	73309	
LIGHT 3	14	73310	
	16	73311	
LIGHT 3.5	12	73461	
	14	73312	
LIGHT 4.0	12	73462	
	16	73313	
DARK 2.5	16	73313	
	18	73314	
DARK 3	14	73315	
	16	73316	
DARK 3.5	12	73463	
	14	73317	
DARK 4.0	12	73464	

NEW



LARAWAY'S™

GINGER SNAP

COLOR	SIZE	CODE	F
PMD	14	74586	
	16	74587	
	18	74588	



MERCER'S™

GOLD BEAD POXYBACK PMD BRASS BEAD

COLOR	SIZE	CODE	E
PMD	16	19300	
	18	19301	



EGAN'S™

GTI CADDIS TUNGSTEN BEAD

COLOR	SIZE	CODE	G
AMBER	12	70243	
	14	70244	
CREAM	12	70246	
	14	70247	
OLIVE	12	70249	
	14	70250	



MAKTIMA'S™

HDA FAV VARIANT JIGGED TUNGSTEN BEAD

COLOR	SIZE	CODE	G
	12	70251	
	14	70252	
	16	70253	



HOTWIRE CADDIS BRASS BEAD

COLOR	SIZE	CODE	F
CHARTREUSE	14	SIG0209	
	16	SIG0210	
OLIVE	14	SIG0212	
	16	SIG0213	



BURK'S™

HUNCHBACK INFREQUENS

COLOR	SIZE	CODE	D
PMD	16	14596	
	18	14597	



MAKTIMA'S™

ICU MIDGE TUNGSTEN BEAD

COLOR	SIZE	CODE	DD
RED	16	10731	
	18	10732	

NYMPHS & WET FLIES

NEW



SMITHERMAN'S™

IMMORTAL MAY

COLOR	SIZE	CODE	DD
BLACK	16	74308	
	18	74309	
	20	74310	
OLIVE	16	74311	
	18	74312	
	20	74313	
PMD	16	74314	
	18	74315	
	20	74316	



INFERNO-GONS

COLOR	SIZE	CODE	D
BLACK	12	74145	
	14	74146	
	16	74147	
	18	74148	
BLAZE	12	74137	
	14	74138	
	16	74139	
	18	74140	
OLIVE	12	74149	
	14	74150	
	16	74151	
	18	74152	
PINK	12	74153	
	14	74154	
	16	74155	
	18	74156	
PURPLE	12	74141	
	14	74142	
	16	74143	
	18	74144	



EGAN'S™

IRON LOTUS TUNGSTEN BEAD

COLOR	SIZE	CODE	E
OLIVE	14	19373	
	16	19374	
	18	19375	



EGAN'S™

IRON LOTUS JIG TUNGSTEN BEAD

COLOR	SIZE	CODE	F
	14	72825	
	16	72826	



IRON SALLY BRASS BEAD

COLOR	SIZE	CODE	DD
	12	SIG1715	
	14	SIG0226	
	16	SIG0227	
	18	SIG2190	



IRON SALLY TUNGSTEN BEAD

COLOR	SIZE	CODE	F
	12	SIG1716	
	14	SIG1460	
	16	SIG1461	
	18	SIG2191	



IRON SALLY JIG TUNGSTEN BEAD

COLOR	SIZE	CODE	G
	14	72831	
	16	72832	



HANNER'S™

JIGGED GREEN DRAKE TUNGSTEN BEAD

COLOR	SIZE	CODE	G
	10	70333	
	12	70334	



MERCER'S™

JIGGY DRAKE TUNGSTEN BEAD

COLOR	SIZE	CODE	F
GREEN	10	73809	
	12	73810	



GTI CADDIS LANCE EGAN

“The GTI Caddis is more imitative than most of my patterns. It represents a hydropsychidae larvae, commonly called “net builder” Caddis. Though a bit cheesy, GTI stands for Go-To imitation. This pattern truly is my go-to when wanting a weighted fly that closely imitates a favored large food form of Trout. One thing you’ll notice when comparing real Hydropsycha to my imitation is that the back on the GTI does not necessarily match any of the color combinations of the real insect. This isn’t by chance. I’ve spent a fair bit of time tying and trying Caddis larva imitations and I’ve come to learn a bit about what fish prefer in the process. For reasons unknown to me, Trout consistently prefer this fly when tied with a shell back color that contrasts the under body. I’ve tried many imitations that more closely represent the actual colors of Caddis larvae, but the fish do not take them as well. There is something magical about the contrasting colors. Try it, you’ll like it... Get a few GTI’s and fish them in your favorite Trout water.”

- Signature Tyer Lance Egan

HARE'S EARS



FLASHBACK HARE'S EAR

COLOR	SIZE	CODE	B
NATURAL	14	13695	
	16	13696	
	18	13697	



GOLD BEAD HARE'S EAR

COLOR	SIZE	CODE	C
NATURAL	10	14642	
	12	14643	
	14	14577	
	16	14578	
	18	14575	



GOLD RIBBED HARE'S EAR

COLOR	SIZE	CODE	B
NATURAL	10	13968	
	12	13969	
	14	13970	
	16	13971	
	18	13972	
	20	13973	



GOLD RIBBED HARE'S EAR TUNGSTEN BEAD

COLOR	SIZE	CODE	D
NATURAL	12	17949	
	14	17950	
	16	17951	
	18	17952	



GUIDE'S CHOICE HARE'S EAR BRASS BEAD

COLOR	SIZE	CODE	E
NATURAL	12	12423	
	14	12427	
	16	12428	
	18	12429	
NATURAL/ PINK	12	74077	
	14	74078	
	16	74079	
	18	74080	
OLIVE	12	19136	
	14	19137	
	16	19138	
	18	19139	



GUIDE'S CHOICE HARE'S EAR TUNGSTEN BEAD

COLOR	SIZE	CODE	F
NATURAL	12	19504	
	14	19505	
	16	19506	
	18	19507	



JIGGED HARE'S EAR JIGGED TUNGSTEN BEAD

COLOR	SIZE	CODE	E
HARE'S EAR	8	19813	
	10	19814	
	12	19815	
	14	19816	
	16	19817	



NYMPHS CONTINUED



THURMAN'S™

JIG NATION

COLOR	SIZE	CODE	F
BROWN	16	74029	
	18	74034	
BWO	16	74027	
	18	74032	
GREEN DRAKE	10	74030	
MARCH BROWN	10	74031	
PMD	16	74028	
	18	74033	



MERCER'S™

JIGGY CADDIS PUPA

COLOR	SIZE	CODE	F
AMBER	14	72408	
	16	72409	
OLIVE	14	72410	
	16	72411	



MERCER'S™

JIGGY MICRO MAY TUNGSTEN BEAD

COLOR	SIZE	CODE	F
BLACK	14	73811	
	16	73812	
	18	73813	
OLIVE	14	73814	
	16	73815	
	18	73816	
PHEASANT TAIL	14	73817	
	16	73818	
	18	73819	
RED	14	73820	
	16	73821	
	18	73822	



MERCER'S™

JIGGY PMD NYMPH

COLOR	SIZE	CODE	F
	14	72412	
	16	72413	



MERCER'S™

JIGSTER

COLOR	SIZE	CODE	F
BAETIS	14	73172	
	16	73173	
	18	73174	
PMD	14	73175	
	16	73176	
	18	73177	



CRAVEN'S™

JUJU BAETIS

COLOR	SIZE	CODE	DD
BAETIS	16	12751	
	18	12752	
	20	12753	
	22	12754	
PURPLE	16	10462	
	18	10463	
	20	10467	
	22	10468	
RED	16	19674	
	18	19675	
	20	19676	
	22	19677	
YELLOW	16	73441	
	18	73442	
	20	73443	
	22	73444	
CAMO	16	73445	
	18	73446	
	20	73447	
	22	73448	



CRAVEN'S™

JUJU BAETIS TUNGSTEN BEAD

COLOR	SIZE	CODE	E
BAETIS	16	19684	
	18	19685	
	20	19686	
	22	19687	
PURPLE	16	19688	
	18	19689	
	20	19690	
	22	19691	
RED	16	19680	
	18	19681	
	20	19682	
	22	19683	
PINK	16	73449	
	18	73450	
	20	73451	
YELLOW	16	73453	
	18	73454	
	20	73455	
	22	73456	
CAMO	16	73457	
	18	73458	
	20	73459	
	22	73460	



CRAVEN'S™

JUJU PMD

COLOR	SIZE	CODE	DD
PMD	16	10495	
	18	10496	
	20	10497	



CRAVEN'S™

JUJU SALLY

COLOR	SIZE	CODE	DD
SALLY	14	71611	
	16	71612	
	18	71613	

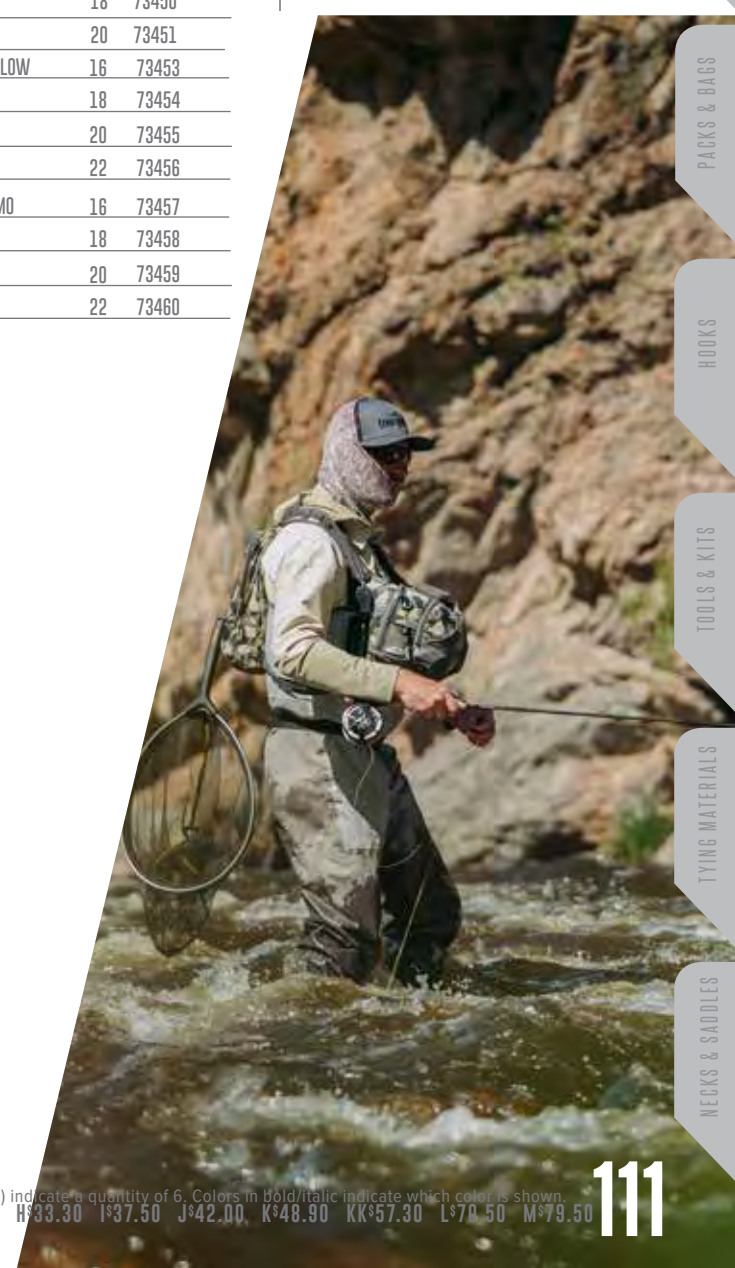

FRESHWATER FLYS
LEADER & TIPPET
ACCESSORIES
PACKS & BAGS
HOOKS
TOOLS & KITS
TYING MATERIALS
NECKS & SADDLES



STREB'S™

**LAZY J STONE JIGGED
JIGGED TUNGSTEN BEAD**

COLOR	SIZE	CODE	G
	10	71645	



THOMPSON'S™

**LIL FOAMY
TUNGSTEN BEAD**

COLOR	SIZE	CODE	E
PURPLE	18	71588	
	20	71589	



OLSEN'S™

**LITE BRITE PERDIGON
TUNGSTEN BEAD**

COLOR	SIZE	CODE	G
UV BLUE	12	72595	
	14	72596	
	16	72597	
	18	74091	
BLACK	12	72598	
	14	72599	
	16	72600	
	18	74088	
PINK	12	72601	
	14	72602	
	16	72603	
	18	74090	
UV PURPLE	12	72604	
	14	72605	
	16	72606	
	18	74092	
BUTANO	12	72607	
	14	72608	
	16	72609	
	18	74089	



SLOAN'S™

**LITTLE BLACK SLOAN
BRASS BEAD**

COLOR	SIZE	CODE	F
BLACK	12	19191	
	14	19192	
	16	19193	



WILCOX'S™

**LITTLE GREEN MACHINE
BRASS BEAD**

COLOR	SIZE	CODE	D
CHARTREUSE	16	SIG0726	
	18	SIG0727	
	20	SIG0728	
GRAY	16	SIG0729	
	18	SIG0730	
	20	SIG0731	
PHEASANT TAIL	16	SIG0732	
	18	SIG0733	
	20	SIG0734	
PURPLE	16	72459	
	18	72460	
	20	72461	



SLOAN'S™

LITTLE YELLOW SLOAN BRASS BEAD

COLOR	SIZE	CODE	F
	14	12279	
	16	12280	



KING'S™

LONG HAIRD HIPPIE

COLOR	SIZE	CODE	F
DARK	6	73236	
	8	73271	
	10	73272	
LIGHT	8	73237	
	10	73273	
	12	73274	



PETTINE'S™

LUCKY CHARM

COLOR	SIZE	CODE	E
SOFT HACKLE	12	73844	
	14	73845	
	16	73846	



JACKSON'S™

MACGRUBER

COLOR	SIZE	CODE	D
BLACK	16	73976	
	18	73977	
	20	73978	
CHOCOLATE	16	73979	
	18	73980	
	20	73981	
GREEN	16	73982	
	18	73983	
	20	73984	
PURPLE	16	73985	
	18	73986	
	20	73987	



PASSAGE'S™

**MAGIC FLY
TUNGSTEN BEAD**

COLOR	SIZE	CODE	DD
BWO	18	70077	
	20	70078	
	22	70079	
PMD	16	70084	
	18	70085	
RUSTY	16	70081	
	18	70082	



MATCHSTICK QUILL JIG

COLOR	SIZE	CODE	E
NATURAL	12	74165	
	14	74166	
	16	74167	
	18	74168	
NATURAL PINK BEAD	12	74371	
	14	74372	
	16	74373	
	18	74374	
OLIVE	12	74169	
	14	74170	
	16	74171	
	18	74172	
PINK	12	74161	
	14	74162	
	16	74163	
	18	74164	
PMD	12	74173	
	14	74174	
	16	74175	
	18	74176	
PURPLE	12	74157	
	14	74158	
	16	74159	
	18	74160	
PURPLE PINK BEAD	12	74367	
	14	74368	
	16	74369	
	18	74370	

NYMPHS & WET FLIES



KELSO'S™

MAYHEM JIG TUNGSTEN BEAD

COLOR	SIZE	CODE	G
NATURAL	12	72610	
	14	72611	
	16	72612	



MERCER'S™

MICRO CRAYFISH

COLOR	SIZE	CODE	E*
RUST	8	14955	



MERCER'S™

MICRO STONE TUNGSTEN BEAD

COLOR	SIZE	CODE	F
BLACK	14	12339	
	16	12340	



HORODYSKY'S™

MOPSCICLE JIGGED TUNGSTEN BEAD

COLOR	SIZE	CODE	F
CHARTREUSE	8	71820	
GRAY	8	71821	
TAN	8	71822	



DORSEY'S™

MERCURY SERIES GLASS BEAD

COLOR	SIZE	CODE
BAETIS	18	14370 C
	20	14371
	22	14372
	24	14380
BLACK BEAUTY	18	14431 B
	20	14432
	22	14433
BLACK BEAUTY FLASHBACK	18	15907 B
	20	15908
	22	15909
FLASHBACK PHEASANT TAIL	16	14416 D
	18	14417
	20	14418
	22	14419
MIDGE/ GRAY	18	14488 B
	20	14489
	22	14490
RS-2 FLASHBACK/GRAY	18	12776 C
	20	12777
	22	12778
	24	12779
RS-2/ GRAY	18	14522 C
	20	14523
	22	14524
	24	14411



NEWMAN'S

MICRO MATCHER

COLOR	SIZE	CODE	D
OLIVE	18	72414	
	20	72415	
	22	72416	



MERCER'S™

MICRO MAYFLY NYMPH BRASS BEAD

COLOR	SIZE	CODE	E
COPPER BEAD/BLACK	14	14080	
	16	14081	
	18	14082	
COPPER BEAD/BROWN	14	14957	
	16	14958	
	18	14959	
COPPER BEAD/OLIVE	14	14987	
	16	14988	
	18	14989	
GLASS BEAD/ BROWN	20	15033	
	22	15034	



MERCER'S™

MICRO STONE NYMPH BRASS BEAD

COLOR	SIZE	CODE	E
LIGHT	14	15041	
	16	15042	
	18	15043	



MERCER'S™

MICRO STONE NYMPH TUNGSTEN BEAD

COLOR	SIZE	CODE	F
LIGHT	14	17851	
	16	17852	
	18	17853	



MILITARY MAYFLY NYMPH

COLOR	SIZE	CODE	DD
OLIVE	16	SIG0567	
	18	SIG0568	
PMD	18	SIG0571	



HORODYSKY'S™

MINI MOPSCICLE TUNGSTEN BEAD

COLOR	SIZE	CODE	F
ORANGE	16	72562	
GRAY	16	72564	
CHARTREUSE	16	72565	



MCCANNEL'S™

NEON NIGHTMARE

COLOR	SIZE	CODE	C
FLOURESCENT ORANGE	18	71740	
	20	71741	
	22	71742	
FLOURESCENT PINK	18	71743	
	20	71744	
	22	71745	



DORSEY'S™

MERCURY SH PHEASANT TAIL

COLOR	SIZE	CODE	F
	14	74554	
	16	74555	
	18	74556	



MERCER'S™

MICRO MAYFLY TUNGSTEN BEAD

COLOR	SIZE	CODE	E
GOLD BEAD/OLIVE	16	17932	
	18	17933	
	20	17934	
TARN GOLD BEAD/OLIVE	14	14088	
	16	14089	
	18	14090	
	20	14091	



MOP BRASS BRASS BEAD

COLOR	SIZE	CODE	C
CHARTREUSE	8	71800	
GRAY	8	71801	
TAN	8	71802	



**NET BUILDER CADDIS
BRASS BEAD**

COLOR	SIZE	CODE	F
AMBER	14	14849	
OLIVE	14	14856	



**NICK'S FAT CADDASS
JIGGED TUNGSTEN BEAD**

COLOR	SIZE	CODE	H
OLIVE	14	70680	
	16	70681	
TAN	14	70686	
	16	70687	



**NITRO CADDIS PUPA
BRASS BEAD**

COLOR	SIZE	CODE	E
OLIVE	14	19339	
	16	19340	
	18	19341	
TAN	14	19342	
	16	19343	
	18	19344	



NORTH FORK SPECIAL

COLOR	SIZE	CODE	E
BLACK/ PB	08	73927	
	10	73928	
	12	73929	
	14	73930	
BLACK/ RB	08	73931	
	10	73932	
	12	73933	
	14	73934	
SILVER BEAD/BLACK	10	13837	
	12	13838	
	14	13839	
GOLD BEAD/TAN	12	13707	
	14	13708	



**NOSEPICKER
BRASS BEAD**

COLOR	SIZE	CODE	D
PMD	16	SIG2043	
	18	SIG2044	



**OCTOBER CADDIS
TUNGSTEN BEAD**

COLOR	SIZE	CODE	H
ORANGE	8	18121	
	10	18122	



**PAT'S BREAD CRUST
BRASS BEAD**

COLOR	SIZE	CODE	DD
	14	70629	
	16	70630	



**PEACHES & CREAM
JIGGED TUNGSTEN BEAD**

COLOR	SIZE	CODE	F
	14	70124	
	16	70125	



PERDICHINGONS

COLOR	SIZE	CODE	G
PEACOCK	16	72389	
	18	72390	
	20	72391	
UV PURPLE	16	72386	
	18	72387	
	20	72388	

NEW



PICKY EATER PERDIGON

COLOR	SIZE	CODE	F
BROWN	14	74177	
	16	74178	
	18	74179	
OLIVE	14	74180	
	16	74181	
	18	74182	



PINK PIERRE

COLOR	SIZE	CODE	E
	16	73772	
	18	73773	



**PLAN C CADDIS
TUNGSTEN BEAD**

COLOR	SIZE	CODE	E
TAN	14	71086	
	16	71087	



**POISON TUNG
TUNGSTEN BEAD**

COLOR	SIZE	CODE	D
GRAY/BLUE	16	11606	
	18	11588	
	20	11589	
OLIVE/BLACK	18	11609	
	20	11611	
PURPLE/ SILVER	16	72486	
	18	72487	
	20	72488	



**POXYBACK
BRASS BEAD**

COLOR	SIZE	CODE	E
CALLIBAETIS	14	14797	
	16	14798	
PMD	16	14802	
	18	14803	
WESTERN GREEN DRAKE	12	14786	



**POXYBACK
BRASS BEAD**

COLOR	SIZE	CODE	E
GREEN DRAKE	12	14649	
HARE'S EAR	12	12513	
	14	12514	
	16	12515	

LYMPHS & WET FLIES



MERCER'S™

POXYBACK BIOT STONE TUNGSTEN BEAD

COLOR	SIZE	CODE	G
GOLD	10	17806	
	12	17807	
	14	17808	



SILVEY'S™

PUPA BRASS BEAD

COLOR	SIZE	CODE	DD
OLIVE	14	SIG0233	
	16	SIG0234	
TAN	14	SIG0235	
	16	SIG0236	



QUILL BOMB

COLOR	SIZE	CODE	F
OLIVE 2.5MM	16	73346	
	18	73347	
OLIVE 3.0MM	14	73348	
	16	73349	
OLIVE 3.5MM	14	73350	
BROWN 2.5MM	16	73351	
	18	73352	
BROWN 3.0MM	14	73353	
	16	73354	
BROWN 3.5MM	14	73355	
BLACK 2.5MM	16	73356	
	18	73357	
BLACK 3.0MM	14	73358	
	16	73359	
BLACK 3.5MM	14	73360	



OLSEN'S™

QUILLDIGON TUNGSTEN BEAD

COLOR	SIZE	CODE	F
YELLOW	12	72583	
	14	72584	
	16	72585	
	18	72586	
NATURAL	12	72587	
	14	72588	
	16	72589	
	18	72590	
PINK	12	72591	
	14	72592	
	16	72593	
	18	72594	



GUNKEL'S™

RADIATION BAETIS TUNGSTEN BEAD

COLOR	SIZE	CODE	E
COPPER/ORANGE	14	70590	
	16	70591	
	18	70592	
	20	70593	
PEACOCK	14	70586	
	16	70587	
	18	70588	
	20	70589	
PINK	16	70595	
	18	70596	
	20	70597	
PURPLE	16	72481	
	18	72482	
	20	72483	

WG Flies have weed guards. **HCB** Flies are packaged with a header card.
 PRICE CODES A\$12.60 B\$15.00 C\$17.70 D\$20.10 DD\$22.50

Price codes accompanied by 10 indicate a quantity of 10. Colors in bold/italic indicate which color is shown.
 E\$24.00 F\$27.30 G\$29.70 H\$33.30 I\$37.50 J\$42.00 K\$48.90 KK\$57.30 L\$70.50 M\$79.50



**CDC FLASHBACK PT
TUNGSTEN BEAD**

COLOR	SIZE	CODE	F
BROWN	12	18086	
	14	18087	
	16	18088	



**COCKTAIL PHEASANT TAIL
TUNGSTEN BEAD**

COLOR	SIZE	CODE	E
	14	71955	
	16	71956	
	18	71957	



FLASHBACK PHEASANT TAIL

COLOR	SIZE	CODE	B
NATURAL	12	13685	
	14	13686	
	16	13687	
	18	13688	
	20	13689	
	22	13690	



**FLASHBACK PHEASANT TAIL
BRASS BEAD**

COLOR	SIZE	CODE	C
NATURAL	12	12526	
	14	12527	
	16	12528	
	18	12529	
	20	12530	



**FLASHBACK PHEASANT TAIL
TUNGSTEN BEAD**

COLOR	SIZE	CODE	D
PHEASANT TAIL	14	17945	
	16	17946	
	18	17947	
	20	17948	



**HOT BELLY PHEASANT TAIL
BRASS BEAD**

COLOR	SIZE	CODE	C
GREEN	16	19782	
	18	19783	
ORANGE	16	19786	
	18	19787	
PURPLE	16	19798	
	18	19799	
PINK	16	19794	
	18	19795	



IMPROVED PHEASANT TAIL

COLOR	SIZE	CODE	D
	12	70898	
	14	70899	
	16	70900	



**JIGGED CDC PHEASANT TAIL
TUNGSTEN BEAD**

COLOR	SIZE	CODE	E
NATURAL/ PINK	12	74083	
	14	74084	
	16	74085	
	18	74086	
PHEASANT TAIL	08	19818	
	10	19819	
	12	19820	
	14	19821	
	16	19822	
	18	74081	
ORANGE	12	72394	
	14	72395	
	16	72396	
	18	74087	
HOT ORANGE	12	72399	
	14	72400	
	16	72401	
	18	74082	



**MERCURY FLASHBACK
PHEASANT TAIL
GLASS BEAD**

COLOR	SIZE	CODE	D
NATURAL	16	14416	
	18	14417	
	20	14418	
	22	14419	



MERCURY SH PHEASANT TAIL

COLOR	SIZE	CODE	F
	14	74554	
	16	74555	
	18	74556	



PHEASANT TAIL

COLOR	SIZE	CODE	B
NATURAL	12	14544	
	14	14545	
	16	14546	
	18	14547	
	20	14548	
	22	14549	
	24	13555	
BLACK	18	14537	
	20	14538	



**PHEASANT TAIL CDC
BRASS BEAD**

COLOR	SIZE	CODE	E
	12	NSN0077	
	14	NSN0078	
	16	NSN0079	
	18	NSN0080	
	20	NSN0642	



**PHEASANT TAIL FLASHBACK SLIM
UNWEIGHTED**

COLOR	SIZE	CODE	B
	18	10318	
	20	10319	
	22	10320	
	24	10321	



**PHEASANT TAIL NYMPH
BRASS BEAD**

COLOR	SIZE	CODE	C
NATURAL	12	14906	
	14	14907	
	16	14908	
	18	14975	
	20	14976	

PHEASANT TAILS



PHEASANT TAIL NYMPH TUNGSTEN BEAD

COLOR	SIZE	CODE	D
PHEASANT TAIL	14	17985	
	16	17986	
	18	17987	
	20	17988	



PHEASANT TAIL SLIM UNWEIGHTED

COLOR	SIZE	CODE	B
	18	10314	
	20	10315	
	22	10316	
	24	10317	



QUASIMODO PHEASANT TAIL BRASS BEAD

COLOR	SIZE	CODE	C
PHEASANT TAIL	14	13898	
	16	13899	
	18	13900	
	20	13901	



FRESHWATER FLYS
LEADER & TIPPET
ACCESSORIES
PACKS & BAGS
HOOKS
TOOLS & KITS
TYING MATERIALS
NECKS & SADDLES



**JIGGED PRINCE
JIGGED TUNGSTEN BEAD**

COLOR	SIZE	CODE	E
PEACOCK	8	19823	
	10	19824	
	12	19825	
	14	19826	
	16	19827	



**PRINCE NYMPH
BRASS BEAD**

COLOR	SIZE	CODE	C
PEACOCK	8	14571	
	10	14561	
	12	14562	
	14	14563	
	16	14564	
	18	14565	



MERCER'S™

**PSYCHO PRINCE
BRASS BEAD**

COLOR	SIZE	CODE	E
BLACK	12	18862	
	14	18863	
	16	18864	
BLUE	12	13801	
	14	13802	
	16	13803	
	18	13804	
CADDIS GREEN	12	13805	
	14	13806	
	16	13810	
	18	13811	
DIRTY PINK	12	13812	
	14	13817	
	16	13820	
ORANGE BELLY	12	13726	
	14	13727	
	16	13728	
	18	13729	
PURPLE	12	13852	
	14	13853	
	16	13854	
	18	13856	



HART'S™

**DARK LORD
BRASS BEAD**

COLOR	SIZE	CODE	DD
BLACK	12	12407	
	14	12404	
	16	12405	
	18	12406	



**KING PRINCE
TUNGSTEN BEAD**

COLOR	SIZE	CODE	E
	12	NSN0719	
	14	NSN0720	
	16	NSN0721	



**PRINCE NYMPH
TUNGSTEN BEAD**

COLOR	SIZE	CODE	D
PEACOCK	12	17990	
	14	17991	
	16	17992	
	18	17993	



**FORMERLY PRINCE
BRASS BEAD**

COLOR	SIZE	CODE	DD
	12	71243	
	14	71244	
	16	71245	



PRINCE CDC BRASS BEAD

COLOR	SIZE	CODE	E
	10	NSN0410	
	12	NSN0411	
	14	NSN0412	
	16	NSN0413	



**HOT WIRED PRINCE
TUNGSTEN BEAD**

COLOR	SIZE	CODE	E
GREEN/YELLOW	14	15495	
	16	15496	
RED/YELLOW	12	14750	
	14	14751	
	16	14752	
	18	14753	



PRINCE NYMPH

COLOR	SIZE	CODE	B
	10	14556	
	12	14557	
	14	14558	
	16	14559	
	18	14560	



CRAVEN'S™

PROBLEM CHILD

COLOR	SIZE	CODE	G
PURPLE	12	73421	
	14	73422	
	16	73423	
	18	73424	
OLIVE	12	73425	
	14	73426	
	16	73427	
	18	73428	
HARE'S EAR	12	73429	
	14	73430	
	16	73431	
	18	73432	



MERCER'S™

**PSYCHO PRINCE RUBBERLEGS
TUNGSTEN BEAD**

COLOR	SIZE	CODE	F
ORANGE BELLY	12	71220	
	14	71221	
	16	71222	
	18	71223	
PURPLE	12	71224	
	14	71225	
	16	71226	
	18	71227	

PRINCES



MERCER'S™

PSYCHO PRINCE JIG TUNGSTEN BEAD

COLOR	SIZE	CODE	G
ORANGE BELLY	12	72807	
	14	72808	
	16	72809	
PURPLE	12	72810	
	14	72811	
	16	72812	



PURPLE PRINCE BRASS BEAD

COLOR	SIZE	CODE	C
	12	13445	
	14	13446	
	16	13447	
	18	13448	



MERCER'S™

TUNGSTEN PHEASANT TAIL PRINCE TUNGSTEN BEAD

COLOR	SIZE	CODE	F
	12	19600	
	14	19601	
	16	19602	

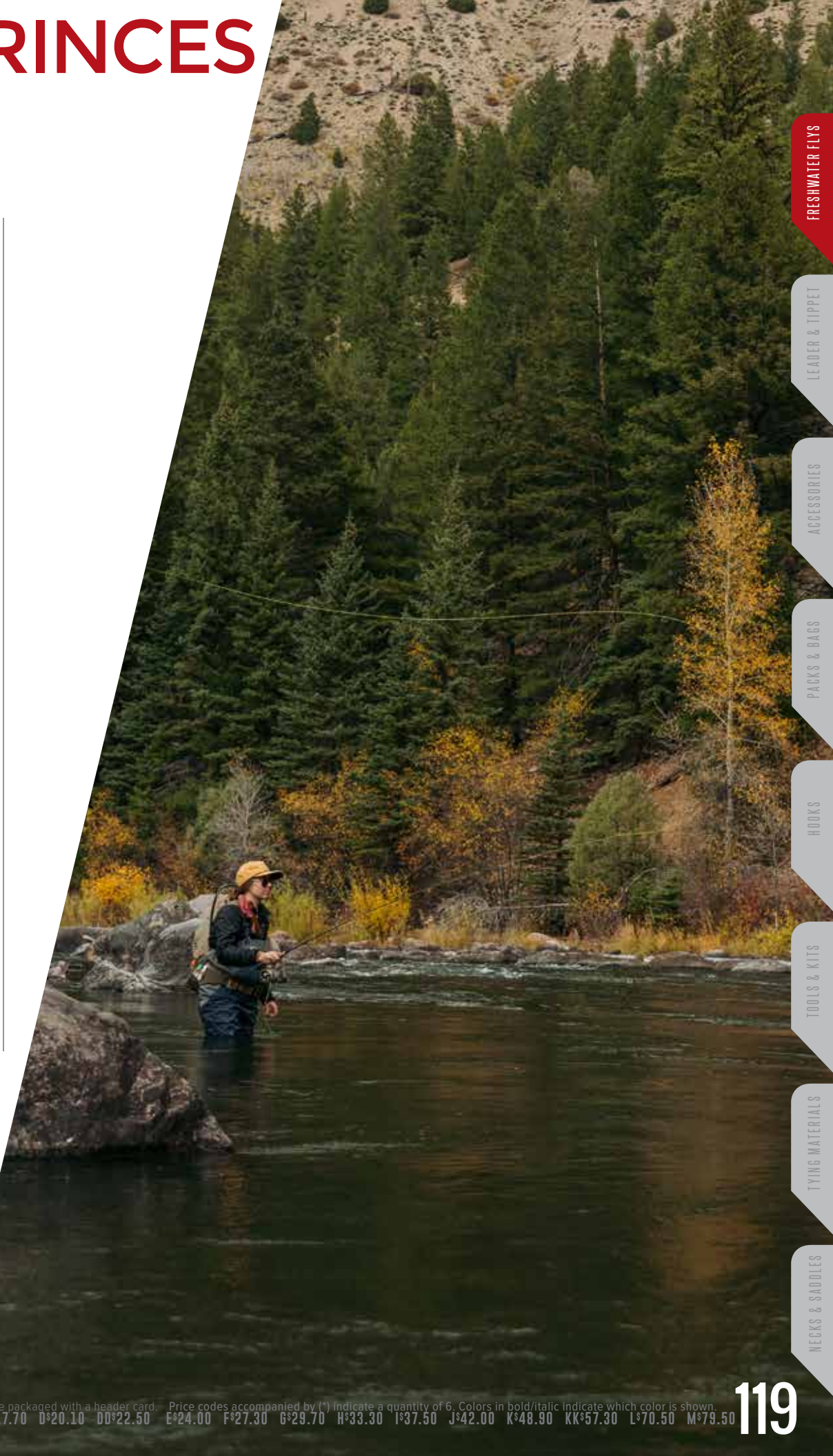

FRESHWATER FLYS

LEADER & TIPPET

ACCESSORIES

PACKS & BAGS

HOOKS

TOOLS & KITS

TYING MATERIALS

NECKS & SADDLES



EGAN'S™

**RAINBOW WARRIOR
TUNGSTEN BEAD**

COLOR	SIZE	CODE	D
BLACK	16	72868	
	18	72869	
	20	72870	
	22	72871	
PEARL	16	13613	
	18	13614	
	20	13615	
	22	13619	
PINK	16	72860	
	18	72861	
	20	72862	
	22	72863	
PURPLE	16	72864	
	18	72865	
	20	72866	
	22	72867	



**RED HEADED STEP CHILD
GLASS BEAD**

COLOR	SIZE	CODE	E
RED	14	SIG0573	
	16	SIG0574	
	18	SIG1079	



RESTLESS STONE

COLOR	SIZE	CODE	D
BLACK	4	NSF0074	
	6	NSF0075	
	8	NSF0076	
	10	NSF0095	
COFFEE/BLACK	4	NSF0077	
	6	NSF0078	
	8	NSF0079	
DARK BROWN	10	NSF0096	
	6	NSF0090	
	8	NSF0091	
DARK BROWN/ORANGE	10	NSF0100	
	6	NSF0087	
	8	NSF0088	
PEACOCK	10	NSF0099	
	8	NSF0107	
	10	NSF0108	
RUSTY OLIVE	12	NSF0109	
	6	NSF0093	
	8	NSF0094	
10	NSF0101		



EGAN'S™

RAINBOW CDC TUNGSTEN

COLOR	SIZE	CODE	F
RAINBOW	14	73275	
	16	73213	
	18	73214	
	20	73215	
	22	73216	



EGAN'S™

**RAINBOW WARRIOR JIG
TUNGSTEN BEAD**

COLOR	SIZE	CODE	F
PEARL	12	72827	
	14	72828	
	16	72829	



EGAN'S™

**RAINBOW WARRIOR X-HVY
TUNGSTEN BEAD**

COLOR	SIZE	CODE	E
PEARL	14	19352	
	16	19353	
	18	19354	



JOHNSON'S™

RIO BANDITO

COLOR	SIZE	CODE	F
CRAW/ ORANGE	12	73480	
	14	73481	
	16	73482	



MERCER'S™

RAG HEX

COLOR	SIZE	CODE	J
	8	18184	



EGAN'S™

**RAINBOW WARRIOR
BRASS BEAD**

COLOR	SIZE	CODE	C
BLACK	18	17617	
	20	17618	
	PEARL	16	17606
PEARL	18	17607	
	20	17608	
	RED	16	17595
18		17596	
20		17597	

WARNING:
Cancer and
Reproductive Harm
www.P65Warnings.ca.gov

SOFT HACKLE



MATHEWS™

GIZMO SOFT HACKLE

COLOR	SIZE	CODE	E
BLACK/ RED	08	73778	
	10	73779	



MATHEWS™

MICRO BEELEY

COLOR	SIZE	CODE	DD
	16	70786	



RED ASS

COLOR	SIZE	CODE	C
	16	17470	
	18	17471	



LEISTER'S™

REMOTE CONTROL SOFT HACKLE

COLOR	SIZE	CODE	D
GRAY	16	74197	
	18	74198	
	20	74199	
OLIVE	16	74200	
	18	74201	
	20	74202	



NEMES™

SOFT HACKLE

COLOR	SIZE	CODE	D
MARCH BROWN SPIDER	12	17436	
	14	17437	
PARTRIDGE&GREEN	14	17459	
PARTRIDGE&ORANGE	14	17449	
PARTRIDGE&PEACOCK	14	17431	
	16	17432	
PARTRIDGE&YELLOW	14	17454	
PHEASANT TAIL	14	17443	
	16	17444	



YEAGER'S™

SOFT HACKLE J TUNGSTEN BEAD

COLOR	SIZE	CODE	E
HARE'S EAR	14	SIG1236	
	16	SIG1237	
	18	SIG1238	



SOFT HACKLE PHEASANT TAIL TUNGSTEN BEAD

COLOR	SIZE	CODE	E
	14	13355	
	16	13356	
	18	13357	



MERCER'S™

SWING CADDIS TUNGSTEN BEAD

COLOR	SIZE	CODE	E
BROWN	14	12632	
	16	12633	
	18	12634	
OLIVE	14	12629	
	16	12630	
	18	12631	



MERCER'S™

SWING NYMPH TUNGSTEN BEAD

COLOR	SIZE	CODE	F
PEACOCK	14	12740	
	16	12741	
	18	12742	



LEADER & TIPPET

ACCESSORIES

PACKS & BAGS

HOOKS

TOOLS & KITS

TYING MATERIALS

NECKS & SADDLES



**RUBBER LEG SQUIRREL NYMPH
BRASS BEAD**

COLOR	SIZE	CODE	E
	8	14703	
	10	14704	
	12	14705	
	14	14706	
	16	14707	



RUBBERLEGS

COLOR	SIZE	CODE	C
BLACK/BROWN LEGS	6	NSF0069	
	8	NSF0070	
	10	71680	
	12	71681	
	14	72462	
COFFEE/BLACK	6	NSF0043	
	8	NSF0044	
	10	71682	
	12	71683	
	14	72464	
DARK BROWN/BROWN	6	NSF0072	
	8	NSF0073	
	10	71686	
	12	71687	
DARK BROWN/OLIVE	6	NSF0054	
	8	NSF0055	
	10	71688	
	12	71689	
DARK BROWN/ORANGE	6	NSF0040	
	8	NSF0041	
	10	71690	
	12	71691	



**RUBBERLEGS JIG
TUNGSTEN BEAD**

COLOR	SIZE	CODE	G
COFFEE/BLACK	6	72839	
	8	72840	
	10	72841	
DARK BROWN/BROWN	6	72842	
	8	72843	
	10	72844	



DRUMMOND'S™

RUSTY NAIL PERDIGON

COLOR	SIZE	CODE	F
	12	73711	
	14	73712	
	16	73713	
	18	73714	



**S&M NYMPH
BRASS BEAD**

COLOR	SIZE	CODE	D
TB/OLIVE	16	SIG1341	
PMD	16	SIG2130	
	18	SIG2131	



SEXY WALTS

COLOR	SIZE	CODE	F
HARE'S EAR 2.5 _{mm}	16	73361	
	18	73362	
HARE'S EAR 3 _{mm}	14	73363	
	16	73364	
HARE'S EAR 3.5 _{mm}	14	73365	
OLIVE 2.5 _{mm}	16	74095	
	18	74096	
OLIVE 3.0 _{mm}	14	74097	
	16	74098	
OLIVE 3.5 _{mm}	14	74099	



ROSENTHAL'S™

SHAGADELIC MOP

COLOR	SIZE	CODE	E
BROWN	10	73873	
TAN	10	73874	
GREEN	10	73875	
CHEETO	10	73876	



GUNKEL'S™

**SHOTGLASS BAETIS
TUNGSTEN BEAD**

COLOR	SIZE	CODE	E
DARK BROWN	16	70575	
	18	70576	
OLIVE	16	70581	
	18	70582	
PURPLE	18	70580	



GUNKEL'S™

SHOTGLASS EMERGER DUN

COLOR	SIZE	CODE	DD
	18	70578	



EGAN'S™

SILVER BULLET BAETIS

COLOR	SIZE	CODE	F
OLIVE	14	73220	
	16	73221	
	18	73222	



**SIZZLIN HOT SPOT SQUIRREL
BRASS BEAD**

COLOR	SIZE	CODE	DD
	14	19284	
	16	19285	



MERCER'S™

**SKWALA STONE
TUNGSTEN BEAD**

COLOR	SIZE	CODE	G
OLIVE	8	11906	
	10	11907	

NEW



OLSEN'S™

SPACE X NYMPH

COLOR	SIZE	CODE	F
	12	74203	
	14	74204	
	16	74205	
	18	74206	



RODRIGUES'S™

SPANISH PERDIGON

COLOR	SIZE	CODE	G
DARK OLIVE	14	72377	
	16	72378	
	18	72379	
DARK OLIVE/RED	14	72380	
	16	72381	
	18	72382	
YELLOW	14	72383	
	16	72384	
	18	72385	
BLACK/ RED	14	73371	
	16	73372	
	18	73373	
BROWN/ RED	14	73374	
	16	73375	
	18	73376	
SUNRISE	14	73377	
	16	73378	
	18	73379	

LYMPHS & WET FLIES



GUNKEL'S™

**SPLATTE ROLLER
TUNGSTEN BEAD**

COLOR	SIZE	CODE	E
CHARTREUSE	14	70583	
	16	70584	
	18	70585	



SILVEY'S™

**SUPER SINKER
TUNGSTEN BEAD**

COLOR	SIZE	CODE	F
BLACK BEAD/BLACK	16	SIG2076	
	18	SIG2077	
GOLD BEAD/BROWN	16	SIG2073	
	18	SIG2074	



OUELLETTE'S™

**STONE DADDY
TUNGSTEN BEAD**

COLOR	SIZE	CODE	G
AMBER/ORANGE	6	70122	
	8	70123	



OUELLETTE'S™

STRAWBERRIES & CREAM

COLOR	SIZE	CODE	F
	14	74416	
	16	74417	
	18	74418	



NEWMAN'S™

STUNTED SALLY

COLOR	SIZE	CODE	F
YELLOW	14	73119	
	16	73120	
	18	73121	



**SUPER PUPA
BRASS BEAD**

COLOR	SIZE	CODE	E
BRIGHT GREEN	14	SIG0051	
	16	SIG0052	
OLIVE	14	SIG0055	
	16	SIG0056	

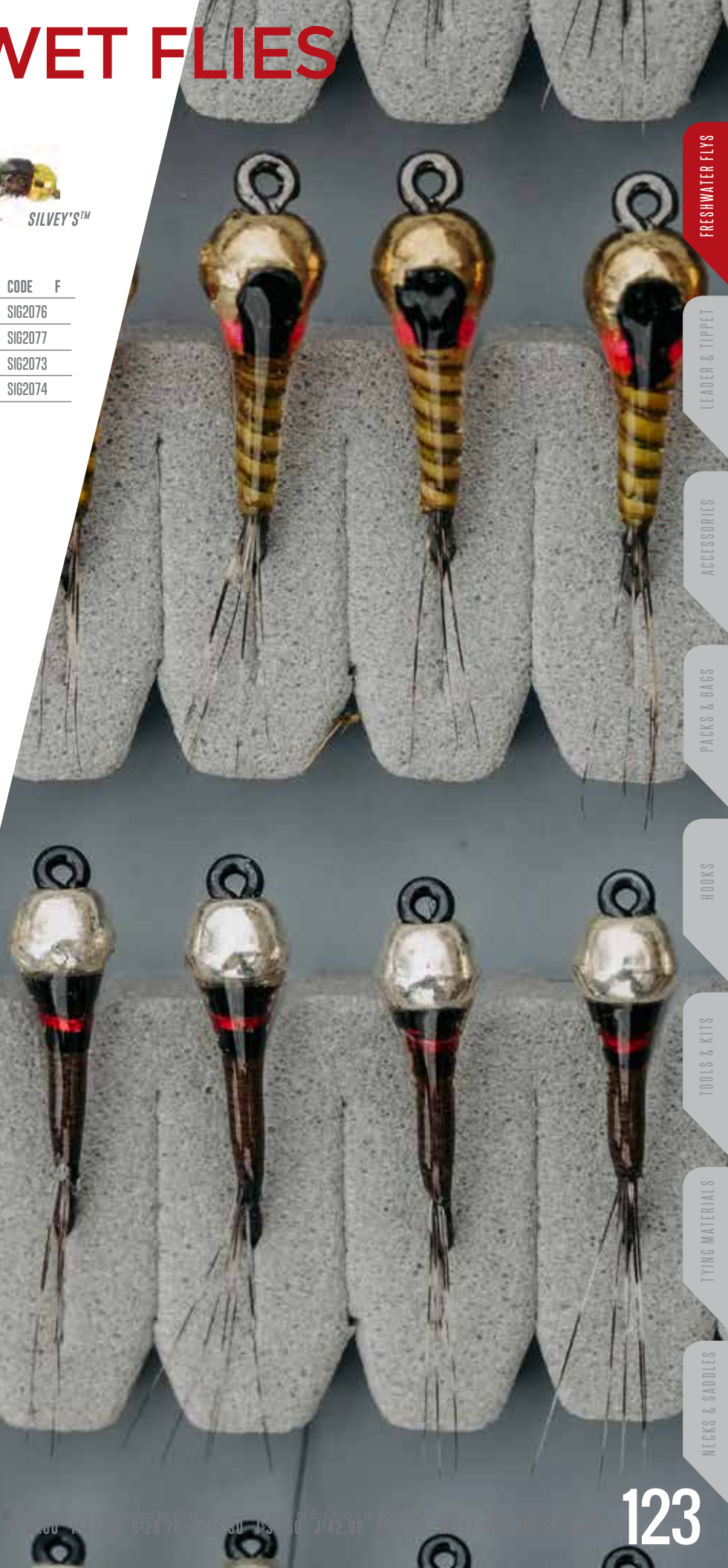

FRESHWATER FLIES

LEADER & TIPPET

ACCESSORIES

PACKS & BAGS

HOOKS

TOOLS & KITS

TYING MATERIALS

NECKS & SADDLES



DOCTOR'S™

SWEETMEAT CADDIS

COLOR	SIZE	CODE	E
TANGERINE	14	73128	
	16	73129	
LIME	14	73130	
	16	73131	



DOCTOR'S™

SWEETMEAT CADDIS DEEP

COLOR	SIZE	CODE	E
TANGERINE	14	74425	
	16	74426	
LIME	14	74427	
	16	74428	

NEW

NEW



DOCTOR'S™

SWEETMEAT SALLY

COLOR	SIZE	CODE	E
	14	74213	
	16	74214	



OUELLETTE'S™

SWEET PEA JIGGED TUNGSTEN BEAD

COLOR	SIZE	CODE	F
OLIVE	16	70380	



TAILWATER TINY TUNGSTEN BEAD

COLOR	SIZE	CODE	DD
BLACK BEAD/BLACK	18	NSN0729	
	20	NSN0730	
	22	NSN0731	
GOLD BEAD/OLIVE	18	NSN0735	
	20	NSN0736	
	22	NSN0737	
BLACK BEAD/RED	18	NSN0738	
	20	NSN0739	
	22	NSN0740	



TASMANIAN DEVIL

COLOR	SIZE	CODE	F
HARE'S EAR 2.5mm	16	73380	
	18	73381	
HARE'S EAR 3mm	14	73382	
	16	73383	
HARE'S EAR 3.5mm	12	73467	
	14	73384	
HARE'S EAR 4.0mm	12	73468	



EGAN'S™

THREAD FRENCHIE JIG

COLOR	SIZE	CODE	F
BLACK	12	72429	
	14	72430	
	16	72431	
NEW	18	74332	
BROWN	12	72426	
	14	72427	
	16	72428	
NEW	18	74333	
OLIVE	12	72423	
	14	72424	
	16	72425	
NEW	18	74334	



MATHEWS™

THREE DOLLAR DIP BRASS BEAD

COLOR	SIZE	CODE	D
BROWN	16	12293	
CRYSTAL	16	12303	
RED	16	12337	



DRUMMOND'S™

TIM'S 0351 TUNGSTEN BEAD

COLOR	SIZE	CODE	E
BAETIS OLIVE	16	72402	
	18	72403	
	20	72404	



DRUMMOND'S™

TIM'S STONE TUNGSTEN BEAD

COLOR	SIZE	CODE	G
DARK	8	71600	
	10	71601	
	12	71602	
LIGHT	8	71603	
	10	71604	
	12	71605	

NEW



DORSEY'S™

TOP SECRET BAETIS

COLOR	SIZE	CODE	C
	16	74557	
	18	74558	
	20	74559	



MERCER'S™

TRIGGER NYMPH BRASS BEAD

COLOR	SIZE	CODE	E
CALLIBAETIS	16	13850	
PMD	16	13890	
	18	13891	



SEXTON'S™

TUNGSTEN CAROTENE JIG

COLOR	SIZE	CODE	F
	10	19891	
	12	19892	
	14	19893	



EGAN'S™

TUNGSTEN DART

COLOR	SIZE	CODE	G
BLUE	12	70200	
	14	70201	
	16	70202	
RED	12	70203	
	14	70204	
	16	70205	
PURPLE	12	73217	
	14	73218	
	16	73219	



COTTER'S™

TUNGSTEN DROWNED ANT

COLOR	SIZE	CODE	D
BLACK	14	19056	
	16	19057	
	18	19058	



DORSEY'S™

TUNGSTEN MERCURY CADDIS

COLOR	SIZE	CODE	E
	16	19539	
	18	19543	

LYMPHS & WET FLIES



EGAN'S™

TUNGSTEN SURVEYOR

COLOR	SIZE	CODE	E
RAINBOW	14	17703	
	16	17704	
	18	17705	



BARR'S™

TUNGSTONE FLASHBACK

COLOR	SIZE	CODE	G
GOLDEN	10	17659	
	12	17660	
	14	17661	
	16	17662	



SMITHERMAN'S™

TWISTED CADDIS

COLOR	SIZE	CODE	E
GREEN	16	73913	
	18	73914	
	20	73915	
OCTOBER	10	73916	
	12	73917	
TAN	16	73918	
	18	73919	
	20	73920	

NEW



SMITHERMAN'S™

TWISTED STONE

COLOR	SIZE	CODE	DD
BLACK	12	74323	
	14	74324	
	16	74325	
BROWN	12	74326	
	14	74327	
	16	74328	
GOLDEN	12	74329	
	14	74330	
	16	74331	



CRAVEN'S™

TWO BIT DRAKE TUNGSTEN BEAD

COLOR	SIZE	CODE	G
GREEN	10	71630	
	12	71631	

NEW



SMITHERMAN'S™

TWISTED CRANE

COLOR	SIZE	CODE	DD
NATURAL	10	74589	
	12	74590	
	14	74591	
TAN	10	74592	
	12	74593	
	14	74594	



FRESHWATER FLYS

LEADER & TIPPET

ACCESSORIES

PACKS & BAGS

HOOKS

TOOLS & KITS

TYING MATERIALS

NECKS & SADDLES



Craven's™

**TWO BIT HOOKER
TUNGSTEN BEAD**

COLOR	SIZE	CODE	F
BLACK	14	10342	
	16	10343	
	18	10344	
BROWN	14	10345	
	16	10348	
	18	10349	
DARK OLIVE	14	10350	
	16	10351	
	18	10354	
LIGHT OLIVE	14	10355	
	16	10356	
	18	10357	
PINK	14	71665	
	16	71666	
	18	71667	
PURPLE	14	71668	
	16	71669	
	18	71670	
RED	14	10366	
	16	10367	
	18	10368	



Craven's™

TWO BIT HOOKER JIG

COLOR	SIZE	CODE	G
BROWN	12	72432	
	14	72433	
	16	72434	
DARK OLIVE	12	72435	
	14	72436	
	16	72437	
LIGHT OLIVE	12	72438	
	14	72439	
	16	72440	
RED	12	72441	
	14	72442	
	16	72443	



Craven's™

**TWO BIT STONE
TUNGSTEN BEAD**

COLOR	SIZE	CODE	G
GOLDEN	8	71168	
	10	71166	
	12	71167	
	14	71203	
	16	71204	
SALLY	14	71621	F
	16	71622	
	18	71623	
DARK	06	73433	
	08	73434	
	10	73435	
	12	73436	



Anderson's™

**UV SALLY
TUNGSTEN BEAD**

COLOR	SIZE	CODE	E
	14	19899	
	16	19900	



Egan's™

WARRIOR PERDIGON

COLOR	SIZE	CODE	E
RAINBOW	12	73732	
	14	73733	
	16	73734	
	18	73735	



Engler's™

WD-40

COLOR	SIZE	CODE	B
BLACK	18	12662	
	20	12663	
	22	12664	
	24	12665	
CHOCOLATE	18	12656	
	20	12657	
	22	12658	
GRAY	24	12659	
	18	13832	
	20	13833	
	22	13834	
	24	13835	
	OLIVE	18	12650
20		12651	
22		12652	
24		12653	



Stout's™

WD-50

COLOR	SIZE	CODE	B
GRAY	18	12682	
	20	12683	
OLIVE	18	12686	
	20	12687	



Befus™

**WIRED STONEFLY
BRASS BEAD**

COLOR	SIZE	CODE	G
GOLDEN	10	14424	
	12	14425	
	14	14426	
	16	14427	



Mercer's™

Z-WING CADDIS

COLOR	SIZE	CODE	E
OLIVE	14	14807	
	16	14808	
	18	14809	



Mercer's™

**Z-WING CADDIS
BRASS BEAD**

COLOR	SIZE	CODE	E
GREEN	14	15044	
	16	15045	
	18	15046	



Mercer's™

**Z-WING CADDIS
TUNGSTEN BEAD**

COLOR	SIZE	CODE	E
OLIVE	14	17796	
	16	17797	
	18	17798	

NEW



ZEBRA JIG

COLOR	SIZE	CODE	F
BLACK/SILVER	16	74375	
	18	74376	
	20	74377	
OLIVE	16	74378	
	18	74379	
	20	74380	
POISON TUNG	16	74390	
	18	74391	
PURPLE	20	74392	
	16	74381	
	18	74382	
RED	20	74383	
	16	74384	
	18	74385	
RUSTY BROWN	20	74386	
	16	74387	
	18	74388	
	20	74389	

LYMPHS & WET FLIES



ZEBRA MIDGE TUNGSTEN BEAD

COLOR	SIZE	CODE	D
BLACK	14	70609	
	16	11918	
	18	11919	
	20	11920	
	22	70610	
BLACK/COPPER	16	11746	
	18	11747	
	20	11748	
OLIVE	16	11823	
	18	11824	
	20	11825	
RED	16	11895	
	18	11896	
	20	11897	
RUSTY BROWN	16	11921	
	18	11922	
	20	11923	
PURPLE	16	72496	
	18	72497	
	20	72498	



CADY'S™

ZEBRA MIDGE TWO TONE TUNGSTEN BEAD

COLOR	SIZE	CODE	DD
BLACK/RED	16	19234	
	18	19235	
	20	19236	



ZEBRA MIDGE THIN TUNGSTEN BEAD

COLOR	SIZE	CODE	D
BLACK	16	71315	
	18	71316	
	20	71317	
	22	71318	
OLIVE	18	71324	
	20	71325	
	22	71326	
PURPLE	18	72493	
	20	72494	
	22	72495	
RED	18	71320	
	20	71321	
	22	71322	
RUST	18	71328	
	20	71329	
	22	71330	

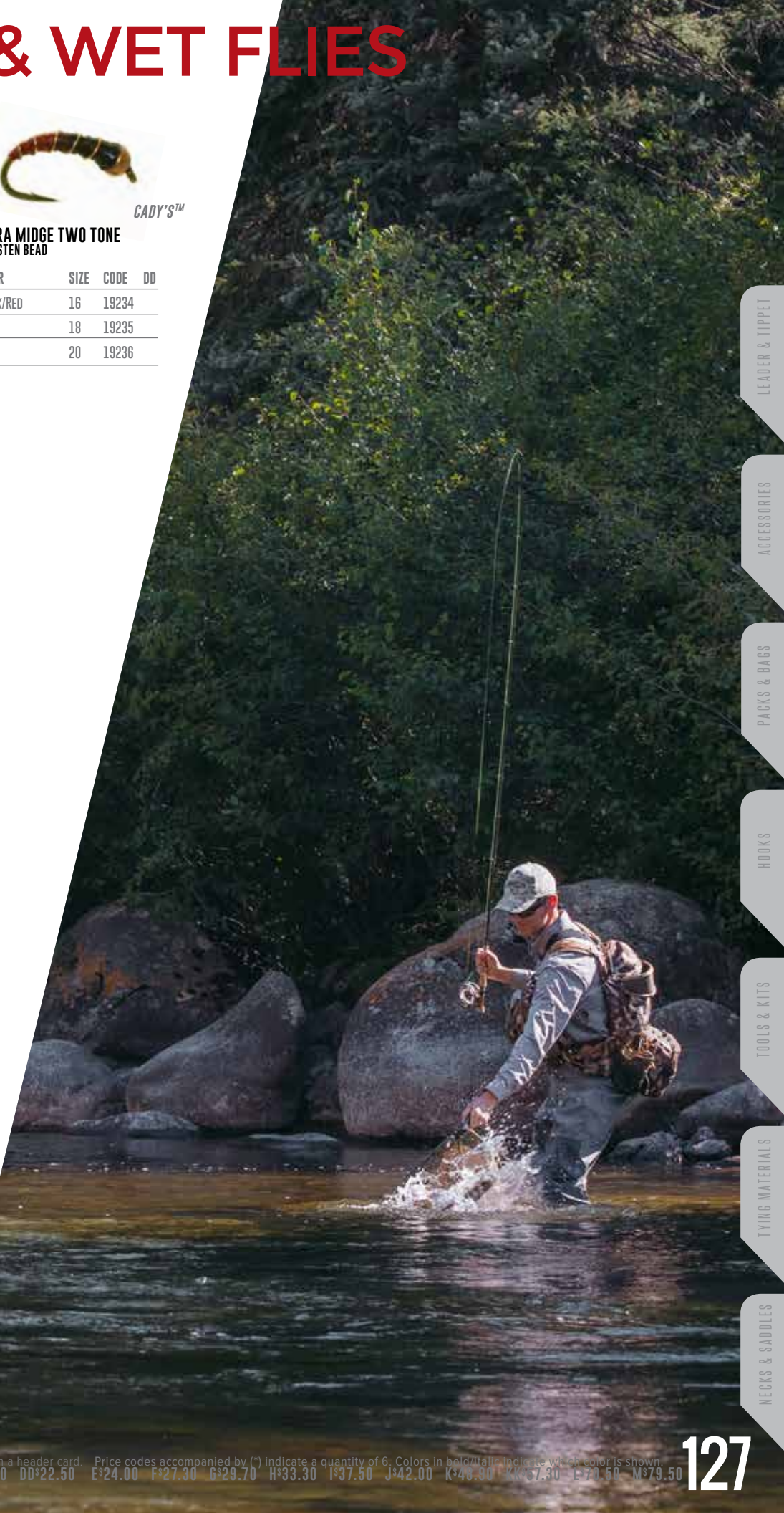

LEADER & TIPPET

ACCESSORIES

PACKS & BAGS

HOOKS

TOOLS & KITS

TYING MATERIALS

NECKS & SADDLES

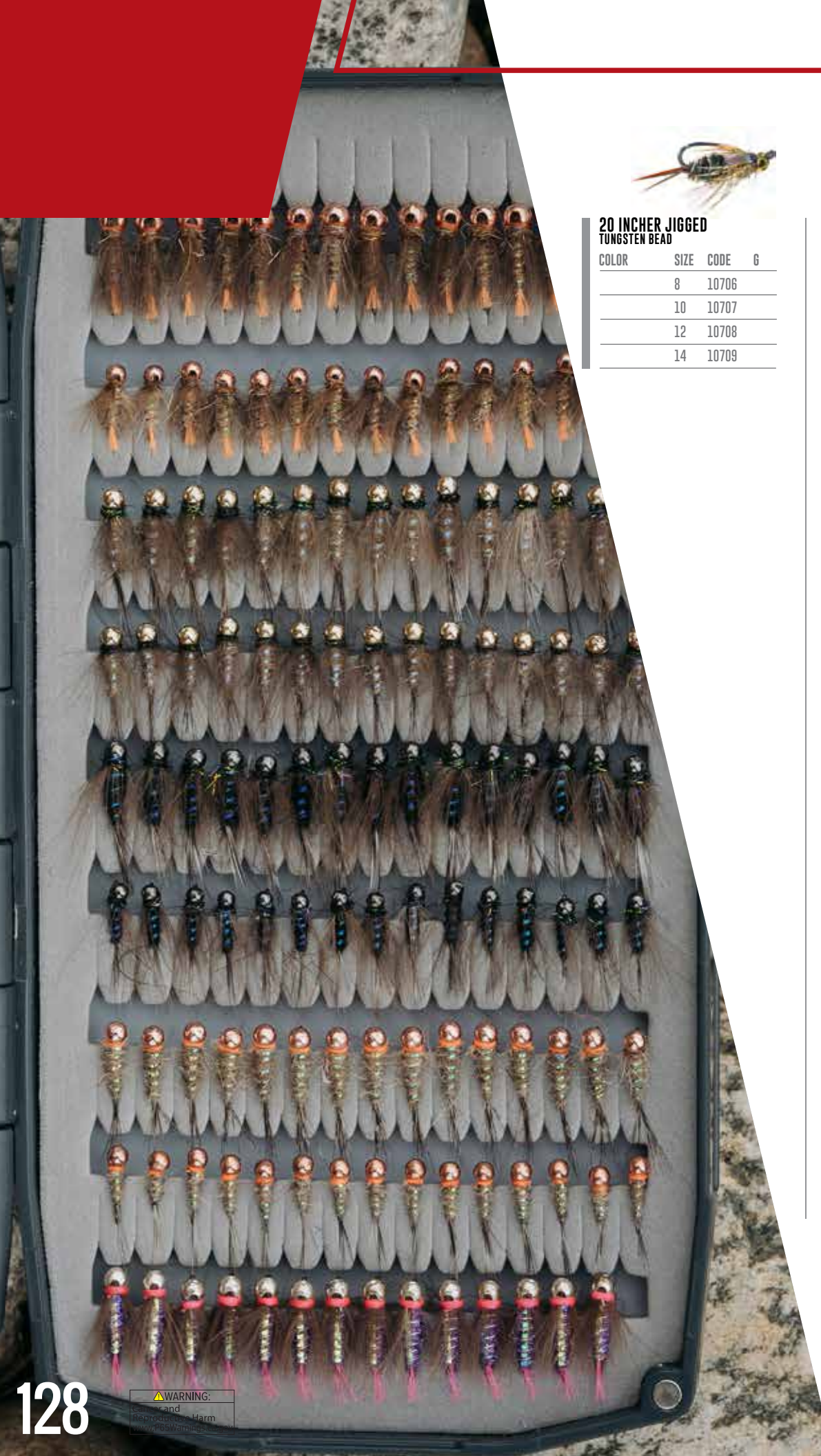

**20 INCHER JIGGED
TUNGSTEN BEAD**

COLOR	SIZE	CODE	G
	8	10706	
	10	10707	
	12	10708	
	14	10709	



NEWMAN'S™

ANTIFREEZE CADDIS

COLOR	SIZE	CODE	E
OLIVE/ BLACK	12	73835	
	14	73836	
	16	73837	
CREAM	12	73838	
	14	73839	
	16	73840	
LIME	12	73841	
	14	73842	
	16	73843	



RODRIGUES™

ANTONIO'S ADULT MAYFLY

COLOR	SIZE	CODE	E
BWO	15	73276	
	17	73277	
	19	73278	
	21	73279	
MARCH BROWN	12	73281	
	14	73282	
PMD	15	73283	
	17	73284	
	19	73285	



RODRIGUES™

ANTONIO'S EMERGER

COLOR	SIZE	CODE	DD
BWO	16	73287	
	18	73288	
	20	73289	
MARCH BROWN	12	73293	
	14	73294	
PMD	16	73295	
	18	73296	

JIGGED/EURO FLIES



ANTONIO'S QUILL MIDGE

COLOR	SIZE	CODE	D
HI VIS	18	73300	
	20	73301	
	22	73302	



ANTONIO'S SUPERMAN CADDIS

COLOR	SIZE	CODE	F
BROWN	12	73305	
	14	73306	
	16	73307	
OLIVE	12	73866	
	14	73867	
	16	73868	
GINGER	12	73870	
	14	73871	
	16	73872	



BACK FLOP

COLOR	SIZE	CODE	H
BLACK	08	74103	
	10	74104	
	12	74105	
OLIVE	08	74106	
	10	74107	
	12	74108	
TAN	08	74109	
	10	74110	
	12	74111	



BC STREAMER

COLOR	SIZE	CODE	F
OLIVE	10	73491	
	12	73492	
	14	73493	
	16	73494	

NEW



BEARDED BAETIS

COLOR	SIZE	CODE	K
OLIVE	16	74264	
	18	74265	
PURPLE	16	74266	
	18	74267	



BIONIC ANT

COLOR	SIZE	CODE	DD
BLACK	10	70189	
	12	70190	
	14	70191	
	16	70192	



BIONIC ANT 2.0

COLOR	SIZE	CODE	DD
BLACK	10	73720	
	12	73721	
	14	73722	
	16	73723	
PURPLE	10	73724	
	12	73725	
	14	73726	
	16	73727	
BROWN	10	73728	
	12	73729	
	14	73730	
	16	73731	



BIOT EPOXY STONE JIG TUNGSTEN BEAD

COLOR	SIZE	CODE	H
DARK	10	72802	
	12	72803	
GOLD	10	72804	
	12	72805	
	14	72806	



BISHOP'S™ DYNAMITE

COLOR	SIZE	CODE	E
BROWN/ORANGE	14	19659	
	16	19660	
	18	19661	



BIZZARO JERRY

COLOR	SIZE	CODE	E
	12	74124	

NEW



BLACK VELVET

COLOR	SIZE	CODE	F
	12	74125	
	14	74126	
	16	74127	
	18	74128	



BLOWTORCH TUNGSTEN BEAD

COLOR	SIZE	CODE	G
UV PURPLE	10	72575	
	12	72576	
	14	72577	
	16	72578	
BLACK	10	72579	
	12	72580	
	14	72581	
	16	72582	
HARE'S EAR	10	73178	
	12	73179	
	14	73180	
	16	73181	



BREAD CRUST JIG

COLOR	SIZE	CODE	F
NATURAL	10	73703	
	12	73704	
	14	73705	
	16	73706	
OLIVE	10	74040	
	12	74041	
	14	74042	
	16	74043	

NEW

NEW



BUCKSKIN JIG

COLOR	SIZE	CODE	E
	14	74429	
	16	74430	
	18	74431	



CBD NYMPH JIG

COLOR	SIZE	CODE	G
BLACK	16	72451	
	18	72452	
LEATHER	16	72445	
	18	72446	
OLIVE	16	72448	
	18	72449	

NEW



CDC CASED CADDIS JIG

COLOR	SIZE	CODE	G
	14	74560	
	16	74561	



CORN-FED CADDIS CDC

COLOR	SIZE	CODE	E
OLIVE	14	17423	
	16	17424	
	18	17425	
NEW	20	74423	
	TAN	14	17426
	16	17427	
	18	17428	
	20	74424	
NEW	PEACOCK	14	74044
		16	74045
		18	74046



CORN-FED CADDIS RUBBERLEGS CDC

COLOR	SIZE	CODE	E
OLIVE	14	72218	
	16	72219	
	14	72215	
TAN	16	72216	



CORN-FED SALLY CDC

COLOR	SIZE	CODE	E
YELLOW	14	19485	
	16	19486	



CZ CADDIS TUNGSTEN TUNGSTEN BEAD

COLOR	SIZE	CODE	G
CREAM	10	18888	
	12	18889	
OLIVE	10	18890	
	12	18891	



CZECH BOMB

COLOR	SIZE	CODE	F
OLIVE 2.5MM	16	73331	
	18	73332	
OLIVE 3.0MM	14	73333	
	16	73334	
OLIVE 3.5MM	14	73335	
	BROWN 2.5MM	16	73336
	18	73337	
	BROWN 3.0MM	14	73338
	16	73339	
	BROWN 3.5MM	14	73340
BLACK 2.5MM	16	73341	
	18	73342	
BLACK 3.0MM	14	73343	
	16	73344	
BLACK 3.5MM	14	73345	



DEEP CLEANER

COLOR	SIZE	CODE	F
COFFEE/ BLACK	4	72371	
	6	72372	
	8	72373	
GOLD STONE	6	72374	
	8	72375	
	10	72376	



DEVIL JIG JIGGED TUNGSTEN BEAD

COLOR	SIZE	CODE	F
BLUE	14	70223	
	16	70224	
	COPPER	14	70461
	16	70462	
	GOLD	14	70226
	16	70227	
	GREEN	14	70229
	16	70230	
	RED	14	70464
	16	70465	



DIABETIS PERDIGON

COLOR	SIZE	CODE	F
BLACK	14	74129	
	16	74130	
	18	74131	
	20	74132	
	OLIVE	14	74133
	16	74134	
	18	74135	
	20	74136	



DURACELL BOMB

COLOR	SIZE	CODE	F
BROWN 2.5MM	16	73318	
	18	73319	
BROWN 3.0MM	14	73320	
	16	73321	
BROWN 3.5MM	12	74365	
	14	73322	
BROWN 4.0MM	12	74366	
	OLIVE 2.5	16	74047
	18	74048	
	OLIVE 3.0	14	74049
	16	74050	
	OLIVE 3.5	12	74051
	14	74052	
	OLIVE 4.0	12	74053
PT 2.5	16	74054	
	18	74055	
PT 3.0	14	74056	
	16	74057	
PT 3.5	12	74058	
	14	74059	
PT 4.0	12	74060	
	UV BLACK 2.5	16	74061
	18	74062	
	UV BLACK 3.0	14	74063
	16	74064	
	UV BLACK 3.5	12	74065
	14	74066	
	UV BLACK 4.0	12	74067
UV HE 2.5	16	74068	
	18	74069	
UV HE 3.0	14	74070	
	16	74071	
UV HE 3.5	12	74072	
	14	74073	
UV HE 4.0	12	74074	



EURO JIG NYMPH JIGGED TUNGSTEN BEAD

COLOR	SIZE	CODE	F
BROWN/PALE YELLOW	14	19951	
	16	19952	
BROWN	14	19948	
	16	19949	
OLIVE FLASH	14	19954	
	16	19955	

JIGGED/EURO FLIES

NEW



EGAN'S™

FRENCHIE TUNGSTEN BEAD

COLOR	SIZE	CODE	E
PHEASANT TAIL	12	12912	
	14	12913	
	16	12914	
	18	12915	



EGAN'S™

FRENCHIE CHIRONOMID

COLOR	SIZE	CODE	E
	10	73223	
	12	73224	
	14	73225	



EGAN'S™

FRENCHIE JIG TUNGSTEN BEAD

COLOR	SIZE	CODE	F
	12	72822	
	14	72823	
	16	72824	



OLSEN'S™

FRONT END LOADER

COLOR	SIZE	CODE	F
GOLDEN	12	71983	
	14	71984	
	16	71985	
TAN	12	71565	
	14	71566	
	16	71567	

NEW



LARAWAY'S™

GINGER SNAP

COLOR	SIZE	CODE	F
PMD	14	74586	
	16	74587	
	18	74588	



GRAFFAM'S™

GOLDEN NUGGET

COLOR	SIZE	CODE	G
BLACK	14	74298	
	16	74299	
	18	74300	
GOLDEN	12	74301	
	14	74302	
	16	74303	



MAKTIMA'S™

HDA FAV VARIANT JIGGED TUNGSTEN BEAD

COLOR	SIZE	CODE	G
	12	70251	
	14	70252	
	16	70253	



HANNER'S™

HOT BEAD JOLLY RANCHER JIGGED TUNGSTEN BEAD

COLOR	SIZE	CODE	F
OLIVE	12	70323	
	14	70324	
BLACK	12	73768	
	14	73769	
WHITE	12	73770	
	14	73771	



GRAFFAM'S™

HUSTLER CDC

COLOR	SIZE	CODE	F
LIGHT 2.5	16	73308	
	18	73309	
LIGHT 3	14	73310	
	16	73311	
LIGHT 3.5	12	73461	
	14	73312	
LIGHT 4.0	12	73462	

HUSTLER CONT.

DARK 2.5	16	73313	
	18	73314	
DARK 3	14	73315	
	16	73316	
DARK 3.5	12	73463	
	14	73317	
DARK 4.0	12	73464	



MAKTIMA'S™

ICU MIDGE TUNGSTEN BEAD

COLOR	SIZE	CODE	DD
RED	16	10731	
	18	10732	



INFERNO-GONS

COLOR	SIZE	CODE	D
BLACK	12	74145	
	14	74146	
	16	74147	
	18	74148	
BLAZE	12	74137	
	14	74138	
	16	74139	
	18	74140	
OLIVE	12	74149	
	14	74150	
	16	74151	
	18	74152	
PINK	12	74153	
	14	74154	
	16	74155	
	18	74156	
PURPLE	12	74141	
	14	74142	
	16	74143	
	18	74144	



EGAN'S™

IRON LOTUS TUNGSTEN BEAD

COLOR	SIZE	CODE	E
OLIVE	14	19373	
	16	19374	
	18	19375	



EGAN'S™

IRON LOTUS JIG TUNGSTEN BEAD

COLOR	SIZE	CODE	F
	14	72825	
	16	72826	



IRON SALLY JIG TUNGSTEN BEAD

COLOR	SIZE	CODE	G
	14	72831	
	16	72832	



THURMAN'S™

JIG NATION

COLOR	SIZE	CODE	F
BROWN	16	74029	
	18	74034	
BWO	16	74027	
	18	74032	
GREEN DRAKE	10	74030	
MARCH BROWN	10	74031	
PMD	16	74028	
	18	74033	



MERCER'S™

**JIGGY DRAKE
TUNGSTEN BEAD**

COLOR	SIZE	CODE	F
GREEN	10	73809	
	12	73810	



MERCER'S™

**JIGGY MICRO MAY
TUNGSTEN BEAD**

COLOR	SIZE	CODE	F
BLACK	14	73811	
	16	73812	
	18	73813	
OLIVE	14	73814	
	16	73815	
	18	73816	
PHEASANT TAIL	14	73817	
	16	73818	
	18	73819	
RED	14	73820	
	16	73821	
	18	73822	



MERCER'S™

JIGGY PMD NYMPH

COLOR	SIZE	CODE	F
	14	72412	
	16	72413	

NEW



MERCER'S™

JIGGY SCUD

COLOR	SIZE	CODE	F
GRAY	12	10668	
	14	74583	
	16	74584	
	18	74585	
OLIVE	14	74580	
	16	74581	
	18	74582	
ORANGE	14	74577	
	16	74578	
	18	74579	



MERCER'S™

JIGSTER

COLOR	SIZE	CODE	F
BAETIS	14	73172	
	16	73173	
	18	73174	
PMD	14	73175	
	16	73176	
	18	73177	



STREB'S™

**LAZY J STONE JIGGED
TUNGSTEN BEAD**

COLOR	SIZE	CODE	G
	10	71645	



OLSEN'S™

**LITE BRITE PERDIGON
TUNGSTEN BEAD**

COLOR	SIZE	CODE	G
UV BLUE	12	72595	
	14	72596	
	16	72597	
	18	74091	
BLACK	12	72598	
	14	72599	
	16	72600	
	18	74088	
PINK	12	72601	
	14	72602	
	16	72603	
	18	74090	
UV PURPLE	12	72604	
	14	72605	
	16	72606	
	18	74092	
BUTANO	12	72607	
	14	72608	
	16	72609	
	18	74089	



MATCHSTICK QUILL JIG

COLOR	SIZE	CODE	E
NATURAL	12	74165	
	14	74166	
	16	74167	
	18	74168	
NATURAL PINK BEAD	12	74371	
	14	74372	
	16	74373	
	18	74374	
OLIVE	12	74169	
	14	74170	
	16	74171	
	18	74172	
PINK	12	74161	
	14	74162	
	16	74163	
	18	74164	
PMD	12	74173	
	14	74174	
	16	74175	
	18	74176	
PURPLE	12	74157	
	14	74158	
	16	74159	
	18	74160	
PURPLE PINK BEAD	12	74387	
	14	74368	
	16	74369	
	18	74370	



KELSO'S™

**MAYHEM JIG
TUNGSTEN BEAD**

COLOR	SIZE	CODE	G
NATURAL	12	72610	
	14	72611	
	16	72612	



HANNER'S™

**JIGGED GREEN DRAKE
TUNGSTEN BEAD**

COLOR	SIZE	CODE	G
	10	70333	
	12	70334	



**JIGGED HARE'S EAR
JIGGED TUNGSTEN BEAD**

COLOR	SIZE	CODE	E
HARE'S EAR	8	19813	
	10	19814	
	12	19815	
	14	19816	
	16	19817	



**JIGGED PRINCE
JIGGED TUNGSTEN BEAD**

COLOR	SIZE	CODE	E
PEACOCK	8	19823	
	10	19824	
	12	19825	
	14	19826	
	16	19827	



MERCER'S™

JIGGY CADDIS PUPA

COLOR	SIZE	CODE	F
AMBER	14	72408	
	16	72409	
OLIVE	14	72410	
	16	72411	

JIGGED/EURO FLIES



MAYER'S™

MINI LEECH JIG RADIANT

COLOR	SIZE	CODE	H
BLACK/ORANGE	12	72313	
	14	72314	
	16	72315	
BLACK/PURPLE	12	72322	
	14	72323	
	16	72324	
OLIVE	12	72316	
	14	72317	
	16	72318	
RUST	12	72319	
	14	72320	
	16	72321	
WHITE/PINK	12	72310	
	14	72311	
	16	72312	



HORODYSKY'S™

MINI MOPSICLE TUNGSTEN BEAD

COLOR	SIZE	CODE	F
ORANGE	16	72562	
GRAY	16	72564	
CHARTREUSE	16	72565	



HORODYSKY'S™

MOPSICLE JIGGED TUNGSTEN BEAD

COLOR	SIZE	CODE	F
CHARTREUSE	8	71820	
GRAY	8	71821	
TAN	8	71822	



ADLER'S™

NICK'S FAT CADDASS JIGGED TUNGSTEN BEAD

COLOR	SIZE	CODE	H
OLIVE	14	70680	
	16	70681	
TAN	14	70686	
	16	70687	



OUELLETTE'S™

PEACHES & CREAM JIGGED TUNGSTEN BEAD

COLOR	SIZE	CODE	F
	14	70124	
	16	70125	



MAKTIMA'S™

PERDICHINGONS

COLOR	SIZE	CODE	G
PEACOCK	16	72389	
	18	72390	
	20	72391	
UV PURPLE	16	72386	
	18	72387	
	20	72388	

NEW



VANDEHEY'S™

PICKEY EATER PERDIGON

COLOR	SIZE	CODE	F
BROWN	14	74177	
	16	74178	
	18	74179	
OLIVE	14	74180	
	16	74181	
	18	74182	



HANNER'S™

PLAN C CADDIS TUNGSTEN BEAD

COLOR	SIZE	CODE	E
TAN	14	71086	
	16	71087	

NEW



EGAN'S™

POACHER

COLOR	SIZE	CODE	H
BLACK	08	74335	
	10	74336	
	12	74337	
OLIVE	08	74338	
	10	74339	
	12	74340	



MERCER'S™

PSYCHO PRINCE JIG TUNGSTEN BEAD

COLOR	SIZE	CODE	G
ORANGE BELLY	12	72807	
	14	72808	
	16	72809	
PURPLE	12	72810	
	14	72811	
	16	72812	



QUILL BOMB

COLOR	SIZE	CODE	F
OLIVE 2.5MM	16	73346	
	18	73347	
OLIVE 3.0MM	14	73348	
	16	73349	
OLIVE 3.5MM	14	73350	
BROWN 2.5MM	16	73351	
	18	73352	
BROWN 3.0MM	14	73353	
	16	73354	
BROWN 3.5MM	14	73355	
BLACK 2.5MM	16	73356	
	18	73357	
BLACK 3.0MM	14	73358	
	16	73359	
BLACK 3.5MM	14	73360	



OLSEN'S™

QUILLDIGON TUNGSTEN BEAD

COLOR	SIZE	CODE	F
YELLOW	12	72583	
	14	72584	
	16	72585	
	18	72586	
NATURAL	12	72587	
	14	72588	
	16	72589	
	18	72590	
PINK	12	72591	
	14	72592	
	16	72593	
	18	72594	



EGAN'S™

RAINBOW CDC TUNGSTEN

COLOR	SIZE	CODE	F
RAINBOW	14	73275	
	16	73213	
	18	73214	
	20	73215	
	22	73216	



EGAN'S™

RAINBOW WARRIOR JIG TUNGSTEN BEAD

COLOR	SIZE	CODE	F
PEARL	12	72827	
	14	72828	
	16	72829	



EGAN'S™

RAINBOW WARRIOR TUNGSTEN BEAD

COLOR	SIZE	CODE	D
BLACK	16	72868	
	18	72869	
	20	72870	
	22	72871	
	PEARL	16	13613
	18	13614	
	20	13615	
	22	13619	
PINK	16	72860	
	18	72861	
	20	72862	
	22	72863	
PURPLE	16	72864	
	18	72865	
	20	72866	
	22	72867	



EGAN'S™

**RAINBOW WARRIOR X-HVY
TUNGSTEN BEAD**

COLOR	SIZE	CODE	E
PEARL	14	19352	
	16	19353	
	18	19354	



JOHNSON'S™

RIO BANDITO

COLOR	SIZE	CODE	F
CRAW/ ORANGE	12	73480	
	14	73481	
	16	73482	



**RUBBERLEGS JIG
TUNGSTEN BEAD**

COLOR	SIZE	CODE	G
COFFEE/BLACK	6	72839	
	8	72840	
	10	72841	
DARK BROWN/BROWN	6	72842	
	8	72843	
	10	72844	



DRUMMOND'S™

RUSTY NAIL PERDIGON

COLOR	SIZE	CODE	F
	12	73711	
	14	73712	
	16	73713	
	18	73714	



SEXY WALTS

COLOR	SIZE	CODE	F
HARE'S EAR 2.5 _{mm}	16	73361	
	18	73362	
HARE'S EAR 3 _{mm}	14	73363	
	16	73364	
HARE'S EAR 3.5 _{mm}	14	73365	
OLIVE 2.5 _{mm}	16	74095	
	18	74096	
OLIVE 3.0 _{mm}	14	74097	
	16	74098	
OLIVE 3.5 _{mm}	14	74099	



EGAN'S™

SILVER BULLET BAETIS

COLOR	SIZE	CODE	F
OLIVE	14	73220	
	16	73221	
	18	73222	

NEW



OLSEN'S™

SPACE X NYMPH

COLOR	SIZE	CODE	F
	12	74203	
	14	74204	
	16	74205	
	18	74206	



RODRIGUES'S™

SPANISH PERDIGON

COLOR	SIZE	CODE	G
DARK OLIVE	14	72377	
	16	72378	
	18	72379	
DARK OLIVE/RED	14	72380	
	16	72381	
	18	72382	
YELLOW	14	72383	
	16	72384	
	18	72385	
BLACK/ RED	14	73371	
	16	73372	
	18	73373	
BROWN/ RED	14	73374	
	16	73375	
	18	73376	
SUNRISE	14	73377	
	16	73378	
	18	73379	



**SQUIRMY WORMIE JIG
TUNGSTEN BEAD**

COLOR	SIZE	CODE	E
BLOOD RED	12	72835	
HOT PINK	12	72836	
RED	12	72837	
TAN	12	72838	



OUELLETTE'S™

STRAWBERRIES & CREAM

COLOR	SIZE	CODE	F
	14	74416	
	16	74417	
	18	74418	



OUELLETTE'S™

**SWEET PEA
JIGGED TUNGSTEN BEAD**

COLOR	SIZE	CODE	F
OLIVE	16	70380	



DOCTOR'S™

SWEETMEAT CADDIS

COLOR	SIZE	CODE	E
TANGERINE	14	73128	
	16	73129	
LIME	14	73130	
	16	73131	



DOCTOR'S™

SWEETMEAT CADDIS DEEP

COLOR	SIZE	CODE	E
TANGERINE	14	74425	
	16	74426	
LIME	14	74427	
	16	74428	

NEW

NEW



DOCTOR'S™

SWEETMEAT SALLY

COLOR	SIZE	CODE	E
	14	74213	
	16	74214	



EGAN'S™

**TAILWATER SOWBUG CDC JIG
TUNGSTEN BEAD**

COLOR	SIZE	CODE	F
	14	73018	
	16	73019	
PINK BEAD	14	74215	
	16	74216	

JIGGED/EURO FLIES

NEW



EGAN'S™

TAILWATER SOWBUG JIG TUNGSTEN BEAD

COLOR	SIZE	CODE	F
	14	72833	
	16	72834	



TASMANIAN DEVIL

COLOR	SIZE	CODE	F
HARE'S EAR 2.5mm	16	73380	
	18	73381	
HARE'S EAR 3mm	14	73382	
	16	73383	
HARE'S EAR 3.5mm	12	73467	
	14	73384	
HARE'S EAR 4.0mm	12	73468	



EGAN'S™

THREAD FRENCHIE JIG

COLOR	SIZE	CODE	F
BLACK	12	72429	
	14	72430	
	16	72431	
NEW	18	74332	
BROWN	12	72426	
	14	72427	
	16	72428	
NEW	18	74333	
OLIVE	12	72423	
	14	72424	
	16	72425	
NEW	18	74334	



SEXTON'S™

TUNGSTEN CAROTENE JIG

COLOR	SIZE	CODE	F
	10	19891	
	12	19892	
	14	19893	



EGAN'S™

TUNGSTEN DART

COLOR	SIZE	CODE	G
BLUE	12	70200	
	14	70201	
	16	70202	
RED	12	70203	
	14	70204	
	16	70205	
PURPLE	12	73217	
	14	73218	
	16	73219	



EGAN'S™

TUNGSTEN SURVEYOR

COLOR	SIZE	CODE	E
RAINBOW	14	17703	
	16	17704	
	18	17705	



SMITHERMAN'S™

TWISTED WORM

COLOR	SIZE	CODE	E
PINK	16/2.5	73921	
	16/3.0	73922	
RED	16/2.5	73923	
	16/3.0	73924	



CRAVEN'S™

TWO BIT HOOKER JIG

COLOR	SIZE	CODE	G
BROWN	12	72432	
	14	72433	
	16	72434	
DARK OLIVE	12	72435	
	14	72436	
	16	72437	
LIGHT OLIVE	12	72438	
	14	72439	
	16	72440	
RED	12	72441	
	14	72442	
	16	72443	



EGAN'S™

WARRIOR PERDIGON

COLOR	SIZE	CODE	E
RAINBOW	12	73732	
	14	73733	
	16	73734	
	18	73735	



ZEBRA JIG

COLOR	SIZE	CODE	F
BLACK/SILVER	16	74375	
	18	74376	
	20	74377	
OLIVE	16	74378	
	18	74379	
	20	74380	
POISON TUNG	16	74390	
	18	74391	
	20	74392	
PURPLE	16	74381	
	18	74382	
	20	74383	
RED	16	74384	
	18	74385	
	20	74386	
RUSTY BROWN	16	74387	
	18	74388	
	20	74389	



ZIRDLE BUG JIG TUNGSTEN BEAD

COLOR	SIZE	CODE	I
OLIVE/BROWN	8	73076	
	10	73077	
	12	73078	
ORANGE/NATURAL	8	73073	
	10	73074	
	12	73075	
ORANGE/OLIVE	8	73070	
	10	73071	
	12	73072	

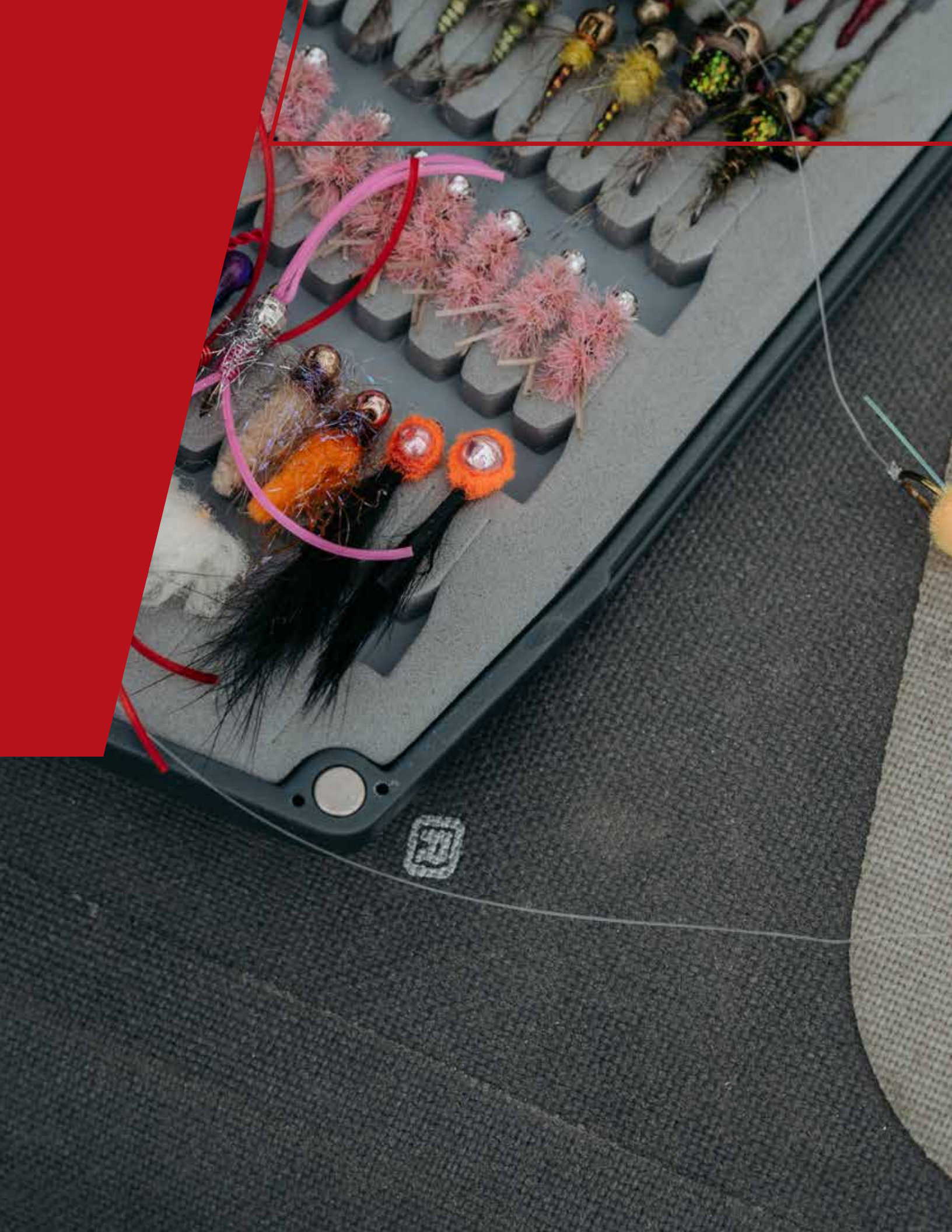

EGGS & WORMS SCUDS & SHRIMP



137



GORMAN'S™

**BEAD HEAD EGG
BRASS BEAD BARBLESS**

COLOR	SIZE	CODE	C
FLOURESCENT ORANGE	6	16352	
	10	16353	
PINK	6	16354	
	10	16355	



HIERONYMUS™

CHOKER

COLOR	SIZE	CODE	I
FLESH	6	70292	



CLOWN EGG

COLOR	SIZE	CODE	C
MULTI	6	19044	
	8	19045	
	10	19046	
	12	19047	
	14	19048	



EGGS TMC 105

COLOR	SIZE	CODE	A
CHARTREUSE	6	19037	
	10	19039	
FLOURESCENT ORANGE	6	19031	
	10	19033	
OREGON CHEESE	6	19007	
	10	19009	
PEACH	6	19025	
	10	19027	
PINK	6	19019	
	10	19021	
PINK CHAMP	10	19002	



FLASHTAIL MINI EGG

COLOR	SIZE	CODE	A
FLOURESCENT ORANGE	14	19075	
	16	19076	
	18	19085	
OREGON CHEESE	14	19077	
	16	19078	
	18	19086	
PINK	14	19079	
	16	19080	
	18	19087	
PINK CHAMPAGNE	14	19081	
	16	19082	
	18	19088	
SALMON EGG	14	19083	
	16	19084	
	18	19092	



METH EGG

COLOR	SIZE	CODE	D
CHARTREUSE	12	18839	
ORANGE	12	18842	



MICRO EGG WEIGHTED

COLOR	SIZE	CODE	A
CHARTREUSE	16	18976	
FLOURESCENT ORANGE	16	18970	
FLOURESCENT RED	16	18978	
SHELL PINK	16	18973	



MICRO SPAWN

COLOR	SIZE	CODE	B
OREGON CHEESE	12	19065	
OREGON CHEESE/FLAME	12	19068	
SHRIMP PINK	12	19071	
STEELHEAD ORANGE	12	19074	



PETTIS™

UNREAL EGG

COLOR	SIZE	CODE	C
CLUSTER DARK ROSE	12	18986	
CLUSTER LIGHT ROSE	12	18989	



KNOWLES™

Y2K BRASS BEAD

COLOR	SIZE	CODE	DD
FL ORANGE/YELLOW	10	15059	
	14	15061	
LIGHT ORANGE/YELLOW	10	15062	
	14	15063	
SALMON EGG/CHAMPAGNE	10	15064	
	14	15065	



EGGS



FRESHWATER FLYS

LEADER & TIPPET

ACCESSORIES

PACKS & BAGS

HOOKS

TOOLS & KITS

TYING MATERIALS

NECKS & SADDLES

PHOTO: WESLEY WHITE

WG Flies have weed guards. HC Flies are packaged with a head of grass. Price codes accompanied by (1) indicate a quantity of 6. Colors in bold/italic indicate which color is shown.
PRICE CODES: A*12.60 B*15.00 C*17.70 D*20.10 E*22.50 F*24.00 G*27.50 H*29.70 I*35.50 J*42.00 K*48.50 **KK*57.30** L*70.50 M*79.50



SAN JUAN WORM

COLOR	SIZE	CODE	A
HOT PINK	10	14891	
	12	14892	
	16	14893	
PURPLE	10	19126	
	12	19127	
	16	19128	
RED	8	14716	
	10	14708	
	12	14709	
	16	14900	
SHELL PINK	10	14885	
	12	14886	
	16	14887	
WINE	10	14712	
	12	14713	
	16	14899	
WORM BROWN	10	14718	
	12	14719	
	16	14898	



**SAN JUAN WORM
BRASS BEAD**

COLOR	SIZE	CODE	D
RED	12	15999	



TWISTED WORM

COLOR	SIZE	CODE	E
PINK	16/2.5	73921	
	16/3.0	73922	
RED	16/2.5	73923	
	16/3.0	73924	



SPAN JUAN WORM

COLOR	SIZE	CODE	C
HOT PINK	16	70024	
RED	16	70028	



UV JUAN

COLOR	SIZE	CODE	E
BROWN	1	19536	
ORANGE	1	19532	
PINK	1	19534	



SQUIRMY WORMIE

COLOR	SIZE	CODE	C
BLOOD RED	10	71270	
	12	71271	
FLOURESCENT ORANGE	10	71278	
	12	71279	
HOT PINK	10	71272	
	12	71273	
RED	10	71274	
	12	71275	
WORM TAN	10	71276	
	12	71277	



**SQUIRMY WORMIE JIG
TUNGSTEN BEAD**

COLOR	SIZE	CODE	E
BLOOD RED	12	72835	
HOT PINK	12	72836	
RED	12	72837	
TAN	12	72838	



SAN JUAN FLASH WORM

COLOR	SIZE	CODE	B
FLOURESCENT PINK	18	19323	
FLOURESCENT RED	18	19325	



SAN JUAN WORM GOLD BEAD

COLOR	SIZE	CODE	B
FLOURESCENT PINK	10	70366	
RED	10	70369	



CANNON'S WORM

COLOR	SIZE	CODE	D
RED	12	19459	
	16	19460	
TAN	12	19461	
	16	19462	



GET DOWN WORM

COLOR	SIZE	CODE	E
RED	6	19657	
	8	19658	

WORMS

FRESHWATER FLYS

LEADER & TIPPET

ACCESSORIES

PACKS & BAGS

HOOKS

TOOLS & KITS

TYING MATERIALS

NECKS & SADDLES



WG Flies have weed guards. **HLC** Flies are packaged with a header card. Price codes accompanied by (*) indicate a quantity of 6. Colors in bold/italic indicate which color is shown.
PRICE CODES A\$12.60 B\$15.00 C\$17.70 D\$20.10 DD\$22.50 E\$24.00 F\$27.30 G\$29.70 H\$33.30 I\$37.50 J\$42.00 K\$48.90 KK\$57.30 L\$70.50 M\$79.50



D MILLER'S™

CANDY CANE MYISIS

COLOR	SIZE	CODE	DD
	18	71417	
	20	71418	



SHANAFELT'S™

CARPET BUG

COLOR	SIZE	CODE	C
GB GRAY	12	73877	
	14	73878	
	16	73879	
GB TAN	12	73881	
	14	73882	
	16	73883	
GRAY	12	73885	
	14	73886	
	16	73887	
TAN	12	73889	
	14	73890	
	16	73891	
	18	73892	



CRAVEN'S™

CHARLIE'S MYISIS

COLOR	SIZE	CODE	DD
	16	19478	
	18	19479	



DORSEY'S™

DORSEY'S™ UV SCUD

COLOR	SIZE	CODE	DD
OLIVE	14	70528	
	16	70529	
ORANGE	14	70526	
	16	70527	



SANDS™

EPOXY MYISIS SHRIMP

COLOR	SIZE	CODE	D
	18	13251	
	20	13252	



MCLELLAN'S™

HUNCHBACK SCUD

COLOR	SIZE	CODE	DD
BIGHORN ORANGE	14	10188	
	16	10189	
GRAY	14	13274	
	16	13275	
OLIVE	14	13276	
	16	13277	
TAN RAINBOW	14	14517	
	16	14518	



MCLELLAN'S™

HUNCHBACK SCUD UV

COLOR	SIZE	CODE	DD
OLIVE/ORANGE	14	13989	
	16	13990	
TAN/PINK	14	13998	
	16	13999	

NEW



MERCER'S™

JIGGY SCUD

COLOR	SIZE	CODE	F
GRAY	12	10668	
	14	74583	
	16	74584	
OLIVE	18	74585	
	14	74580	
	16	74581	
ORANGE	18	74582	
	14	74577	
	16	74578	
	18	74579	



REED'S™

MAGMA MYISIS

COLOR	SIZE	CODE	H
	16	70384	



MAYER'S™

MAYER'S™ MYISIS

COLOR	SIZE	CODE	D
	16	19641	
	18	19642	



PEDERSON'S™

PEDERSON'S SOWBUG

COLOR	SIZE	CODE	DD
TAN/ PINK	14	73988	
	16	73989	



RAY CHARLES

COLOR	SIZE	CODE	C
GRAY	16	NSN0485	
	18	NSN0486	
TAN	16	NSN0494	
	18	NSN0495	



KAUFMANN'S™

SCUD

COLOR	SIZE	CODE	DD
GRAY OLIVE	14	14208	
	16	14209	

NEW



EASDON'S™

SLAP SHOT SCUD

COLOR	SIZE	CODE	F
GRAY	12	70669	
	14	74571	
	16	74572	
OLIVE	14	74575	
	16	74576	
ORANGE	14	74573	
	16	74574	



DAVIDSON'S™

SOW CHOW

COLOR	SIZE	CODE	E
TAN	14	73256	
	16	73257	
	18	73258	
GRAY	14	73685	
	16	73686	
	18	73687	
PINK	14	73688	
	16	73689	
	18	73690	
RAINBOW	14	73691	
	16	73692	
	18	73693	

SCUDS & SHRIMP



DAVIDSON'S™

SOW CHOW TUNGSTEN

COLOR	SIZE	CODE	F
TAN	14	73259	
	16	73260	
	18	73261	
GRAY	14	73694	
	16	73695	
	18	73696	
PINK	14	73697	
	16	73698	
	18	73699	
RAINBOW	14	73700	
	16	73701	
	18	73702	



EGAN'S™

TAILWATER SOWBUG TUNGSTEN BEAD

COLOR	SIZE	CODE	DD
LIGHT OLIVE	14	73034	
	16	73035	
	18	73036	
PINK	14	73029	
	16	73030	
	18	73031	
RAINBOW	10	10664	
	12	10665	
	14	19345	
	16	19346	
	18	19347	



EGAN'S™

TAILWATER SOWBUG

COLOR	SIZE	CODE	C
LIGHT OLIVE	14	73026	
	16	73027	
	18	73028	
PINK	16	73021	
	18	73022	
RAINBOW	10	10656	
	12	10670	
	14	10650	
	16	10651	
	18	10652	



EGAN'S™

TAILWATER SOWBUG CDC

COLOR	SIZE	CODE	D
	14	73015	
	16	73016	
	18	73017	



EGAN'S™

TAILWATER SOWBUG CDC JIG TUNGSTEN BEAD

COLOR	SIZE	CODE	F
	14	73018	
	16	73019	
PINK BEAD	14	74215	
	16	74216	



EGAN'S™

TAILWATER SOWBUG JIG TUNGSTEN BEAD

COLOR	SIZE	CODE	F
	14	72833	
	16	72834	



SLAPSHOT SCUD JON EASDON

“In my belief, one of the most overlooked fly patterns for trout is the scud.

Scuds are an ideal food source for fish and are readily available in most streams, rivers, and lakes. In years past there have not been a whole lot of different scud patterns available. This was the inspiration to create a pattern that even the pickiest fish would inhale. This pattern utilizes a tungsten bead and jig hook that rides with the hook point up. Its the perfect and balanced scud pattern for straight line nymphing and euro nymphing and is also equally effective in stillwater.

The Slap shot is available in a wide array of sizes and colors to cover all of the bases no matter where you are fishing it.”

- Signature Tyer Jon Easdon



LAKE FLIES



145

**ADULT DAMSEL**

COLOR	SIZE	CODE	DD
BLUE	14	11331	

*BURK'S™***ADULT DAMSEL**

COLOR	SIZE	CODE	F
BLUE	10	11333	

**ADULT WIGGLE DAMSEL**

COLOR	SIZE	CODE	DD
	12	TAB0055	

*WINKLER'S™***BALANCED LEATHER LEECH**

COLOR	SIZE	CODE	F
BLACK/ CHART	10	73247	
PEACOCK	10	73248	
PURPLE	10	73249	

*THURMAN'S™***BALANCED SWIMMING LEECH BRASS BEAD**

COLOR	SIZE	CODE	G
BLACK	10	71370	
BROWN	10	71371	
OLIVE	10	71372	

*THURMAN'S™***BALANCED ZACK ATTACK DAMSEL BRASS BEAD**

COLOR	SIZE	CODE	E
OLIVE	12	71373	
	14	71374	

*THEO'S™***BOATMAN**

COLOR	SIZE	CODE	DD
BLACK	12	13855	

*BARR'S™***BOUFACE BRASS BEAD**

COLOR	SIZE	CODE	F
BLACK	8	10029	
	10	10030	

*SCHROEDER'S™***BUBBA'S CALLIBAETIS NYMPH**

COLOR	SIZE	CODE	DD
	14	19552	
	16	19553	

**BUNNY LEECH**

COLOR	SIZE	CODE	D
BLACK	6	13303	
OLIVE	6	13315	

*SCHRANTZ'S™***CALLIBAETIS NYMPH**

COLOR	SIZE	CODE	D
	14	14001	
	16	14002	

*A.K.'S™***CALLIBAETIS SPINNER**

COLOR	SIZE	CODE	DD
	16	12586	

*MAYER'S™***CANDY SHOP CALLIBAETIS**

COLOR	SIZE	CODE	C
	14	73784	
	16	73785	

**CDC BIOT SPINNER**

COLOR	SIZE	CODE	C
CALLIBAETIS	16	15984	

*DEGALA'S™***CDC CALLIBAETIS NYMPH**

COLOR	SIZE	CODE	F
OLIVE	14	19329	
	16	19330	
TAN	14	19331	

**CHIRONOMID BOMBER BRASS BEAD**

COLOR	SIZE	CODE	C
BLACK/RED	10	11791	
	12	11792	
	14	11793	
BLACK/SILVER	10	11794	
	12	11795	
	14	11796	

**CHIRONOMID PUPA BRASS BEAD**

COLOR	SIZE	CODE	C
BLACK/RED	12	11807	
	14	11808	
	16	11809	

**CHROME CHIRONOMID BRASS BEAD**

COLOR	SIZE	CODE	C
	12	MDE0063	
	14	MDE0064	

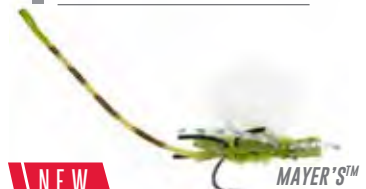
*MAYER'S™***NEW****CHUBBY DAMSEL**

COLOR	SIZE	CODE	I
BLUE	14	74479	
	16	74480	
OLIVE	14	74481	
	16	74482	

*THURMAN'S™***CUT BAIT MIDGE BRASS BEAD**

COLOR	SIZE	CODE	C
RED	10	71363	
	12	71364	

*BARR'S™***DAMSEL**

COLOR	SIZE	CODE	E
OLIVE	12	13928	

LAKE FLIES



DAMSEL

COLOR	SIZE	CODE	D
OLIVE	12	14584	



DAMSEL ADULT

COLOR	SIZE	CODE	C
	12	TDF0001	



SMITHERMAN'S™

DRAGGIN NYMPH

COLOR	SIZE	CODE	G
OLIVE	10	73135	
	14	73136	
TAN	10	73137	
	14	73138	



QUIGLEY'S™

FILM CRITIC

COLOR	SIZE	CODE	E
CALLIBAETIS	14	SIG1632	
	16	SIG1633	



EGAN'S™

FRENCHIE CHIRONOMID

COLOR	SIZE	CODE	E
	10	73223	
	12	73224	
	14	73225	



FROSTBITE CHIRONOMID BRASS BEAD

COLOR	SIZE	CODE	C
RED	12	18762	
	14	18763	
	16	18764	



CHUBBY DAMSEL LONDON MAYER

"I have a vivid memory of when I first witnessed, at age 14, a brown trout leap out of the water and snag an electric blue adult damsel out of the air. It was jaw-dropping! Ever since that experience, I have had the occasional awesome take here or there, but I could not find a damselfly that would float like a cork and appear natural.

Trout are more willing to take a large dry fly like a damsel when it surfs in and out of view with a big fish chop. Then one day it hit me—take some of the features of the best floating attractor dries ever, the Chubby. With a slim 2mm foam body, black synthetic legs like the adult. Instead of a second pair of legs, the bared flake silly legs represent the wet wings on the surface like stabilizers on a canoe.

The poly yarn tuft is a great sighter for tracking the fly. While the extended damsel braid tail completes the realistic look with the tip coated in resin to prevent fraying. The "Chubby Damsel" olive blue is now my mothership for dropping the Mini Leech Jig, Mini Leech Jig Radiant, and Mini Leech Jig Damsel."

- Signature Tyer Landon Mayer



GOAT LEECH

COLOR	SIZE	CODE	E
BLACK/ RED	10	17473	
CANADIAN BROWN	10	17475	
CANADIAN OLIVE	10	17477	



HELL RAZOR LEECH

COLOR	SIZE	CODE	J
BLACK	12	71720	
NATURAL GRAY	12	71721	
OLIVE	12	71722	



HOT BEAD JOLLY RANCHER JIGGED TUNGSTEN BEAD

COLOR	SIZE	CODE	F
OLIVE	12	70323	
	14	70324	
BLACK	12	73768	
	14	73769	
WHITE	12	73770	
	14	73771	



HOT HEAD MINI LEECH

COLOR	SIZE	CODE	H
BLACK	14	74414	
	16	74415	
OLIVE	14	74412	
	16	74413	



DEGALA'S™

HULA DAMSEL

COLOR	SIZE	CODE	J
OLIVE	16	19337	
TAN	16	19338	



ICE CREAM CONE BRASS BEAD

COLOR	SIZE	CODE	C
BLACK	12	MDE0069	
	14	MDE0070	
	16	MDE0081	
BRIGHT RED	10	MDE0093	
	12	MDE0094	
	14	MDE0095	
	16	MDE0096	



CRAVEN'S™

JUMBO JUJU CHIRONOMID BRASS BEAD

COLOR	SIZE	CODE	E
BLOOD	12	17535	
	14	17536	
	16	17537	
OLIVE	12	17538	
	14	17539	
	16	17540	
ZEBRA	12	17541	
	14	17542	
	16	17543	

NEW



DAVIDSON'S™

LED CHIRONOMID

COLOR	SIZE	CODE	F
BLACK	14	74632	
	16	74633	



DORSEY'S™

LIGHTNING LEECH

COLOR	SIZE	CODE	H
WHITE	06	73125	
BLACK	06	73127	



MAY DAY

COLOR	SIZE	CODE	E
CALLIBAETIS	13	70624	
	15	70625	



MAYER'S™

MINI LEECH, MAYER'S

COLOR	SIZE	CODE	F
OLIVE	14	71365	
	16	71366	
BLACK	14	70406	
	16	70407	
BROWN	14	70408	
	16	70409	



MAYER'S™

MINI LEECH JIG TUNGSTEN BEAD

COLOR	SIZE	CODE	H
BLACK	12	72023	
	14	72024	
	16	72025	
BROWN	12	72017	
	14	72018	
	16	72019	
OLIVE	12	72020	
	14	72021	
	16	72022	



MAYER'S™

MINI LEECH JIG DAMSEL

COLOR	SIZE	CODE	G
OLIVE	14	73167	
	16	73168	
	18	73139	
TAN	14	73328	
	16	73329	
	18	73330	



MAYER'S™

MINI LEECH JIG RADIANT

COLOR	SIZE	CODE	H
BLACK/ORANGE	12	72313	
	14	72314	
	16	72315	
BLACK/PURPLE	12	72322	
	14	72323	
	16	72324	
OLIVE	12	72316	
	14	72317	
	16	72318	
RUST	12	72319	
	14	72320	
	16	72321	
WHITE/PINK	12	72310	
	14	72311	
	16	72312	



NO NAME DAMSEL

COLOR	SIZE	CODE	D
OLIVE/BROWN	12	11336	

LAKE FLIES



PARACHUTE

COLOR	SIZE	CODE	D
ADAMS	12	12041	
	14	12042	
	16	12043	
	18	12044	
	20	12045	
	22	12046	
	24	12047	
	26	12048	



MERCER'S™

POXYBACK CALLIBAETIS

COLOR	SIZE	CODE	E
CALLIBAETIS	14	14797	
	16	14798	



LECOUNT'S™

PICKY FISH DAMSEL

COLOR	SIZE	CODE	E
OLIVE	12	19938	



CRAVEN'S™

PINE SQUIRREL LEECH BRASS BEAD

COLOR	SIZE	CODE	G
BLACK	12	19692	
BROWN	12	19693	
OLIVE	12	19694	



MILLER'S™

POPS BUGGER BRASS BEAD

COLOR	SIZE	CODE	F
BLACK	8	10598	
	10	10599	
COPPER/OLIVE	8	10604	
	10	10612	
OLIVE/BLACK	8	10614	
	10	10615	
OLIVE/CHARTREUSE	8	10622	
	10	10623	
PEARL/GRIZZLY	8	10626	
	10	10627	
PURPLE/ORANGE BEAD	8	10629	
	10	10632	
ROOTBEER/ORANGE	8	10636	
	10	10637	



THURMAN'S™

PYRAMID BEACH LEECH

COLOR	SIZE	CODE	H
BLACK	8	74409	
OLIVE/ PCK	8	74410	
BROWN	8	74411	



LEADER & TIPPET

ACCESSORIES

PACKS & BAGS

HOOKS

TOOLS & KITS

TYING MATERIALS

NECKS & SADDLES

NEW



RUBY EYED LEECH BRASS BEAD

COLOR	SIZE	CODE	E
BLACK/RED	8	13316	
CANADIAN OLIVE	8	13317	



MERCER'S™

STEALTH LINK

COLOR	SIZE	CODE	H
CALLIBAETIS	14	73829	
	16	73830	



ROBERTSON'S™

SCOTT'S DAMSEL

COLOR	SIZE	CODE	E
OLIVE	14	16668	



TAKAHASHI'S™

TAK'S CRYSTAL CHIRONOMID

COLOR	SIZE	CODE	E
	12	19473	
	14	19474	



ROBERTSON'S™

SCOTT'S DAMSEL BUGGER

COLOR	SIZE	CODE	E
	12	16674	



MAYER'S™

TITAN TUBE MIDGE BRASS BEAD

COLOR	SIZE	CODE	D
BLACK/RED	12	71148	
	14	71149	
	16	71150	
BLACK/SILVER	12	71151	
	14	71152	
	16	71153	



SEXTON'S™

SEXTON'S BOOBY

COLOR	SIZE	CODE	D
BLACK	8	70894	
PURPLE	8	70895	
CHARTREUSE/WHITE	8	70896	
OLIVE	8	71184	



MERCER'S™

TRIGGER NYMPH BRASS BEAD

COLOR	SIZE	CODE	E
CALLIBAETIS	16	13850	



BURK'S™

SIERRA DAMSEL

COLOR	SIZE	CODE	DD
OLIVE	12	13876	



MATHEWS™

SPARKLE DUN

COLOR	SIZE	CODE	D
CALLIBAETIS	14	11116	
	16	15796	



BLUMENSHINE'S™

TUNGSTEN JUNIOR MINT JIGGED TUNGSTEN BEAD

COLOR	SIZE	CODE	I
	10	70771	
	12	70772	
	14	70773	
	16	70774	

LAKE FLIES



TUNGSTEN THIN MINT TUNGSTEN BEAD

COLOR	SIZE	CODE	F
COPPER	6	70512	
	8	70513	
	10	70510	
	12	70511	
OLIVE/BROWN/BLACK	6	13287	
	8	13288	
	10	13289	
	12	70272	

NEW



SMITHERMAN'S™

TWISTED DAMSEL

COLOR	SIZE	CODE	F
OLIVE	14	74819	
	16	74820	



THURMAN'S™

ZACK ATTACK DAMSEL

COLOR	SIZE	CODE	E
OLIVE	14	71174	
OLIVE/ORANGE	14	71175	



CADY'S™

ZEBRA TWO-TONE TUNGSTEN BEAD

COLOR	SIZE	CODE	DD
BLACK/RED	16	19234	
	18	19235	
	20	19236	

NEW



TOKACH'S™

Z NAIL

COLOR	SIZE	CODE	G
	12	74661	

WG Flies have weed guards. HCB Flies are packaged with a header card. Price codes accompanied by (1) indicate a quantity of 6. Colors in bold/italic indicate which color is shown.

PRICE CODES A*12.60 B*15.00 C*17.70 D*20.10 DD*22.50 E*24.00 F*27.30 G*28.70 H*33.30 I*37.50 J*42.00 K*48.90 KK*57.30 L*70.50 M*73.50

FRESHWATER FLIES

LEADER & TIPPET

ACCESSORIES

PACKS & BAGS

HOOKS

TOOLS & KITS

TYING MATERIALS

NECKS & SADDLES



STREAMERS



153



**AUTUMN SPLENDOR
BRASS CONE**

HENG'S™

COLOR	SIZE	CODE	I
	4	18059	
	6	18060	
	8	18061	



**BREAD N' BUTTER BUGGER
BRASS CONE**

COLLIER'S™

COLOR	SIZE	CODE	I
BLONDE	4	12433	
	6	12434	
	8	12435	



**CONEHEAD JJ SPECIAL
BRASS CONE**

COLOR	SIZE	CODE	E
	4	BST0198	
	6	BST0199	
	8	BST0200	



**CRYSTAL BUGGER JIG
TUNGSTEN BEAD**

COLOR	SIZE	CODE	G
BLACK	6	72845	
	10	72846	
OLIVE	6	72847	
	10	72848	
PURPLE	6	72849	
	10	72850	
WHITE	6	72851	
	10	72852	



**CRYSTAL BUGGER
BRASS BEAD**

COLOR	SIZE	CODE	DD
BLACK	6	13218	
	8	13219	
	10	13220	
	12	13221	
CHARTREUSE	6	13233	
	8	13234	
	10	13235	
	12	13236	
COPPER BROWN	6	13223	
	8	13224	
	10	13225	
	12	13226	
OLIVE	6	13228	
	8	13229	
	10	13230	
	12	13231	
PURPLE	6	13238	
	8	13239	
	10	13240	
WHITE	6	13253	
	8	13254	
	10	13255	
	12	13256	



**CRYSTAL BUGGER RUBBER LEGS
BRASS BEAD**

COLOR	SIZE	CODE	E
BLACK	6	13244	
	8	13245	
	10	13246	
OLIVE	6	13248	
	8	13249	
	10	13250	



EGG SUCKING CRYSTAL LEECH

COLOR	SIZE	CODE	DD
BLACK	4	13409	
PURPLE	4	13414	



**FLASH-A-BUGGER
BRASS BEAD**

COLOR	SIZE	CODE	E
PEACOCK/BLACK	6	13310	
	8	13311	
	10	13312	



**HOT BEAD BUGGER
BRASS CONE**

COLOR	SIZE	CODE	E
BLACK/CHARTREUSE	6	16222	
	8	16223	
	10	16224	
FLOURESCENT ORANGE	6	16226	
	8	16227	
	10	16228	



**HOT BEAD JOLLY RANCHER
TUNGSTEN BEAD**

COLOR	SIZE	CODE	F
OLIVE	12	70323	
	14	70324	
BLACK	12	73768	
	14	73769	
WHITE	12	73770	
	14	73771	



NINE LB HAMMER

COLOR	SIZE	CODE	I
BLUE/GRAY	06	73670	
	08	73671	
	10	73672	
CRAW	06	73673	
	08	73674	
	10	73675	
OLIVE/NAT	06	73676	
	08	73677	
	10	73678	



**"POPS" BUGGER
BRASS BEAD**

COLOR	SIZE	CODE	F
BLACK	8	10598	
	10	10599	
COPPER/OLIVE	8	10604	
	10	10612	
OLIVE/BLACK	8	10614	
	10	10615	
OLIVE/CHARTREUSE	8	10622	
	10	10623	
PEARL/GRIZZLY	8	10626	
	10	10627	
PURPLE/ORNGE BEAD	8	10629	
	10	10632	
ROOTBEER/ORANGE	8	10636	
	10	10637	

BUGGERS



MENA'S™

SLIDER BUGGER

COLOR	SIZE	CODE	KK
WHITE	02	73226	
BLACK	02	73227	
OLIVE/ GINGER	02	73228	
BROWN/ YELLOW	02	73229	



TUNGSTEN THIN MINT TUNGSTEN BEAD

COLOR	SIZE	CODE	F
OLIVE/BROWN/BLACK	6	13287	
	8	13288	
	10	13289	
COPPER	12	70272	
	6	70512	
	8	70513	
COPPER	10	70510	
	12	70511	



BECK'S™

SUPER BUGGER

COLOR	SIZE	CODE	H
TAN	04	13633	
	06	13638	
	08	13639	
OLIVE	04	13634	
	06	13372	
	08	13373	
BLACK	04	13374	
	06	13375	
	08	13376	



WOOLLY BUGGER

COLOR	SIZE	CODE	D
BLACK/BLACK/BLACK	6	13464	
	8	13465	
	10	13466	
BROWN/BROWN/BROWN	12	13467	
	6	13484	
	8	13485	
BROWN/BROWN/BROWN	10	13486	
	12	13487	
	OLIVE/OLIVE/OLIVE	6	13504
8		13505	
10		13506	
12	13507		



TEQUEELY BRASS BEAD

COLOR	SIZE	CODE	F
	4	BST0112	
	6	BST0113	



WOOLLY BUGGER BRASS BEAD

COLOR	SIZE	CODE	DD
PEACOCK/GRIZZLY	6	13307	
	8	13308	
	10	13309	



BLUMENSHINE'S™

TUNGSTEN JUNIOR MINT TUNGSTEN BEAD

COLOR	SIZE	CODE	I
	10	70771	
	12	70772	
	14	70773	
	16	70774	



WOOLLY BUGGER JIG TUNGSTEN BEAD

COLOR	SIZE	CODE	G
PEACOCK/BLACK	6	72853	
	10	72854	
PEACOCK/GRIZZLY	6	72855	
	10	72856	

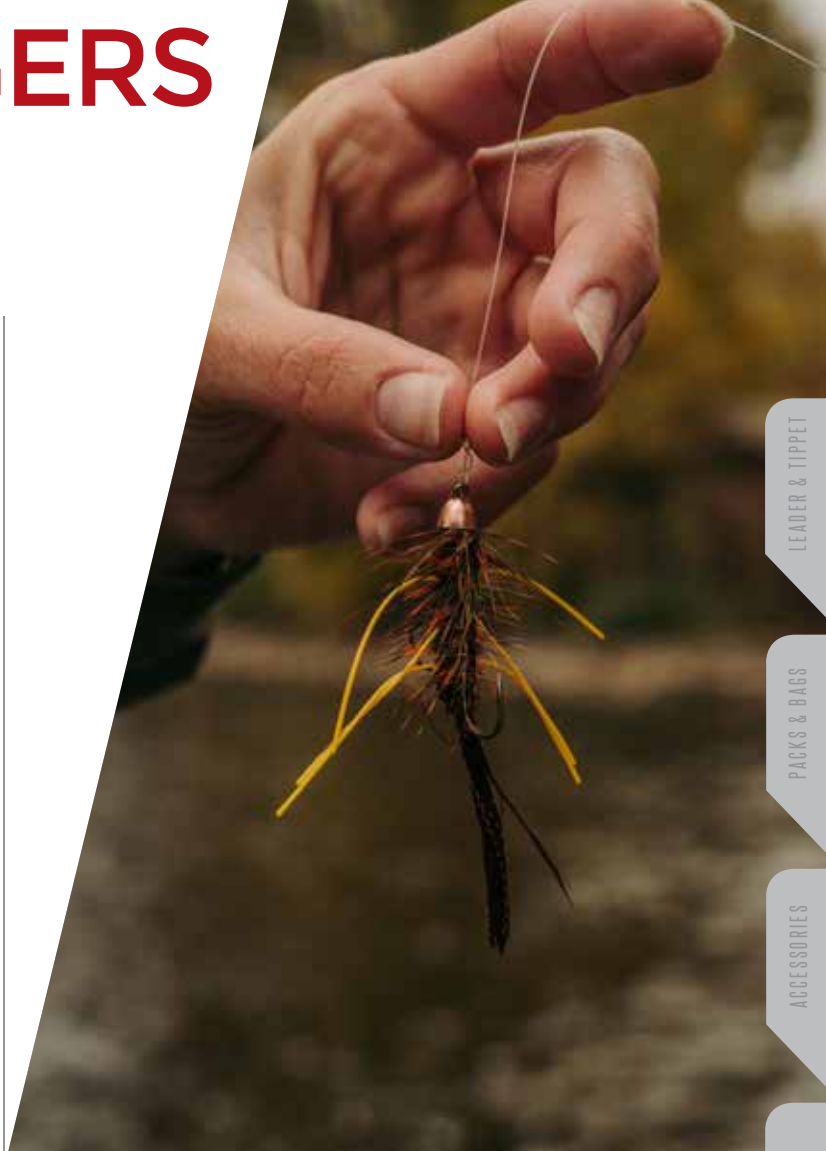

AUTUMN SPLENDOR TIM HENG

Tim Heng's (Taylor Creek, Basalt, CO) Autumn Splendor has been a very good producer for many years.

The larger sizes are great for trout fishing from the boat or wading, while the smaller sizes are a delight for panfishing.



ANDREW'S™

BEAR'S CROSSDRESSER

COLOR	SIZE	CODE	F
FRY	4	14163	



BENNETT'S™

BENNETT'S™ LUNCH \$

COLOR	SIZE	CODE	KK
CRAWDAD	2	72028	
	6	72029	
BROWN TROUT	2	70631	
	6	70632	
RAINBOW	2	72026	
	6	72027	
SHAD	2	70635	
	6	70636	
TAN	2	70637	
	6	70638	



JOHNSON'S™

BC STREAMER

COLOR	SIZE	CODE	F
OLIVE	10	73491	
	12	73492	
	14	73493	
	16	73494	



BUNNY LEECH

COLOR	SIZE	CODE	D
BLACK	6	13303	
OLIVE	6	13315	



JOHNSON'S™

CHUCKWAGON

COLOR	SIZE	CODE	H*
BLACK/ PURPLE	02	73253	
DIRTY OLIVE	02	73254	
CHARTREUSE	02	73255	



CIRCUS PEANUT

COLOR	SIZE	CODE	I*
BLACK/BLOOD	4x4	19747	
OLIVE	4x4	19749	
WHITE	4x4	19750	



CLOUSER MINNOW

COLOR	SIZE	CODE	
BLACK	2/0	15110	H
	2	15111	G
	6	15112	G
BLUE/WHITE	2/0	16720	H
	2	16721	G
	6	16722	G
CHARTREUSE/WHITE	2/0	16750	H
	2	16751	G
	4	16726	G
CHARTREUSE/YELLOW	2/0	15115	H
	2	15116	G
	6	15117	G
CRABBY	2/0	17144	H
	2	17145	G
	6	17146	G
FOXEE RED	6	16776	G
GOLDEN SHINER	2	16766	G
	6	16767	G
	OLIVE/WHITE	2/0	16723
	2	16724	G
	6	16725	G
PINK/WHITE	2/0	17141	H
	2	17142	G
	6	17143	G
RED/WHITE	2/0	15120	H
	2	15121	G
	6	15122	G
SCULPIN	2	16756	G
	6	16757	G
	SEXY SHAD	2/0	19963
	2	19964	H
	6	19965	G
SILVER SHINER	2/0	16760	H
	2	16761	G
	6	16762	G
BABY SMALLMOUTH	2	16587	G
	6	16585	G
	TUTTI FRUITI	2/0	16137
	2	16138	G
	6	16139	H
WHITE	2/0	15271	H
	2	15272	G
	6	15273	G

NEW



WHITE'S™

AKOBE FLY

COLOR	SIZE	CODE	J*
BLACK/RED	06	73935	
WHITE/RED	06	73936	
YEL/CHART	06	73937	



OLSEN'S™

BACK FLOP

COLOR	SIZE	CODE	H
BLACK	08	74103	
	10	74104	
	12	74105	
OLIVE	08	74106	
	10	74107	
	12	74108	
TAN	08	74109	
	10	74110	
	12	74111	

NEW



SILVEY'S™

BALANCED SCULPIN

COLOR	SIZE	CODE	E*
BLACK	06	74276	
OLIVE	06	74277	
TAN	06	74278	
WHITE	06	74279	

STREAMERS



COLONEL KURTZ BRASS BEAD

COLOR	SIZE	CODE	J
WHITE	6	71382	
BROWN	6	71383	



COUSIN IT SCULPIN JIG TUNGSTEN BEAD

COLOR	SIZE	CODE	K
GINGER	6	73061	
OLIVE	6	73060	



COWBELL CRAY BRASS CONE

COLOR	SIZE	CODE	I
OLIVE	6	73081	
RUST	6	73080	
TAN	6	73079	



CREEK LEECH

COLOR	SIZE	CODE	I
CRAW DRG	04	73485	
	08	73486	
OLIVE	04	73489	
	08	73490	



DIRTY HIPPIY

COLOR	SIZE	CODE	KK
BLACK	4	70775	
BROWN	4	70041	
PLATTE	4	70776	
RAINBOW	4	70042	



DITCH WITCH

COLOR	SIZE	CODE	F
BLACK/ RED	02	73965	
	06	73966	
GREEN	02	73967	
	06	73968	
WHITE/ TAN	02	73969	
	06	73970	
YELLOW	02	73971	
	06	73972	



DOUBLE DIRTY HIPPIY HC

COLOR	SIZE	CODE	L
BLACK	2	70782	
BROWN	2	70779	
PLATTE	2	70781	
RAINBOW	2	70780	



DOUBLE FUEGO

COLOR	SIZE	CODE	L
COPPER	2x4	73059	
GOLD	2x4	73058	
HOLO SILVER	2x4	73057	



DOLLY LLAMA BRASS CONE

COLOR	SIZE	CODE	I
BLACK/WHITE	2	19873	
CHART/PINK	2	19875	
DARK OLIVE/WHITE	2	19879	
WHITE	2	19880	
FLESH/CREAM	2	19876	
HOT PINK/PURPLE	2	19877	
OLIVE/WHITE	2	19878	



DOLLY LLAMA MINI BRASS CONE

COLOR	SIZE	CODE	I
BLACK/OLIVE	2	72067	
BLACK/WHITE	2	72068	
OLIVE/WHITE	2	72070	
DARK OLIVE/WHITE	2	72071	
WHITE	2	72072	



DOLLY LLAMA WITH EGG BRASS CONE

COLOR	SIZE	CODE	I
DARK OLIVE/WHITE	2	19883	
BLACK/WHITE	2	19881	
FLESH/CREAM	2	19882	



DRAGON

COLOR	SIZE	CODE	K*
BABY BROWN	2x6	73052	
BABY SUCKER	2x6	73053	
BLACK	2x6	73056	
SCULPIN	2x6	73055	
WHITEY	2x6	73054	



DRAGON MINI

COLOR	SIZE	CODE	K*
BABY BROWN	6X8	73047	
BABY SUCKER	6X8	73048	
BLACK	6X8	73051	
SCULPIN	6X8	73050	
WHITEY	6X8	73049	



FISH WHACKER

COLOR	SIZE	CODE	K*
TAN	04	71375	
DARK BROWN	04	71376	
OLIVE	04	71380	
WHITE	04	71381	



FISH WHACKER MINI

COLOR	SIZE	CODE	J*
DARK BROWN	06	74015	
OLIVE	06	74016	
TAN	06	74017	
WHITE	06	74018	



FLOATING SMELT

COLOR	SIZE	CODE	E*
PEARL	2	18334	
	6	18335	



**GAMECHANGER
HC (4.5" LENGTH)**

COLOR	SIZE	CODE	L*
PEARL/WHITE	2/0	70313	
RAINBOW	2/0	70314	



ZIMMERMAN'S™

GEEZUS LIZARD

COLOR	SIZE	CODE	K*
BLACK/OLIVE	1/0	19302	
CRAYFISH	1/0	19303	



CRAVEN'S™

GONGA, BABY

COLOR	SIZE	CODE	KK
BLACK	8	70456	
OLIVE	8	70457	
RAINBOW	8	70688	
RUST	8	70458	
TAN/YELLOW	8	70459	
GRAY	8	71996	



CRAVEN'S™

GONGA, DOUBLE HC

COLOR	SIZE	CODE	J*
BLACK	4X4	19743	
OLIVE	4X4	19744	
RAINBOW	4X4	70689	
RUST	4X4	19745	
TAN/YELLOW	4X4	19746	
GRAY	4X4	71997	



GRAY GHOST

COLOR	SIZE	CODE	F
	6	16402	
	8	16403	
	10	16404	



GUMMY MINNOW HC

COLOR	SIZE	CODE	
BLUE	2	15752	J*
	6	15753	H*
BROWN	2	15086	J*
	6	15620	H*
CHARTREUSE	2	16170	J*
	6	16171	H*
CLEAR	6	15021	H*
GREEN	2	15087	J*
	6	15089	H*
PEARL	2	15088	J*
	6	15619	H*



HARE SCULPIN

COLOR	SIZE	CODE	D*
GOLD	4	16693	
	6	16694	
OLIVE	4	16696	
	6	16703	



MCCANNEL'S™

HELL RAZOR CROW

COLOR	SIZE	CODE	I
NATURAL GRAY	12	71715	
ORANGE	12	71716	



HUDSPETH'S™

HUD'S BUSHWACKER

COLOR	SIZE	CODE	H*
BLUEGILL	1	70739	
SHAD	2/0	70391	
CHARTREUSE/WHITE	2/0	70393	



WINKLER'S™

KAMIKAZE SCULPIN

COLOR	SIZE	CODE	K
GOLD	4	71210	
	8	71211	
GRAY	4	71212	
	8	71416	
OLIVE	4	71213	
	8	71214	



KRAFT'S™

KREELEX MINNOW

COLOR	SIZE	CODE	I
GOLD/SILVER	4	71856	
	6	71857	
	8	71858	
COPPER/GOLD	4	71861	
	6	71862	
	8	71863	
COPPER/GOLD/SILVER	4	71865	
	6	71866	
	8	71867	



**LI'L KIM
BRASS CONE**

COLOR	SIZE	CODE	I
COPPER CONE/COPPER	4	SIG2093	
	8	SIG2094	
GOLD CONE/GOLD	4	SIG2095	
	8	SIG2096	
SILVER CONE/SILVER	4	SIG2097	
	8	SIG2098	



BARR'S™

MEAT WHISTLE BRASS CONE

COLOR	SIZE	CODE	G*
BLACK	2	10701	
	1/0	10840	
CHARTREUSE	2	10704	
	1/0	10697	
CRAWDAD	2	10702	
	1/0	10844	
OLIVE	2	10703	
	1/0	10842	
VRILE CRAYFISH	2	10695	
	1/0	10694	
WHITE	2	10705	
	1/0	10699	



CONNER'S™

MIDNIGHT MINNOW HC

COLOR	SIZE	CODE	DD*
	6	19480	

NEW



SMITHERMAN'S™

MOUNTAIN LOBSTER

COLOR	SIZE	CODE	KK
OLIVE	08	73906	
	12	73907	
ORANGE	08	73908	
	12	73909	

STREAMERS



MUDDLER MINNOW

COLOR	SIZE	CODE	F
	6	16550	
	8	16551	
	10	16552	



MURDICH'S™

MURDICH™ MINI MINNOW HC

COLOR	SIZE	CODE	H*
GRAY/WHITE	4	70888	
CHARTREUSE/WHITE	4	70889	
COPPER	4	70891	
GOLD	4	70892	
COPPER/YELLOW	4	70893	



FRESHWATER FLYS

LEADER & TIPPET

PACKS & BAGS

ACCESSORIES

HOOKS

TOOLS & KITS

TYING MATERIALS

NECKS & SADDLES

NEW



CRAVEN'S™

NINE LB HAMMER

COLOR	SIZE	CODE	I
BLUE/GRAY	06	73670	
	08	73671	
	10	73672	
CRAW	06	73673	
	08	73674	
	10	73675	
OLIVE/NAT	06	73676	
	08	73677	
	10	73678	



SKINNY WATER CLOUSER MINNOW HC

COLOR	SIZE	CODE	F
CHARTREUSE/WHITE	4	16749	
	6	16739	
GRAY/WHITE	6	16742	
PINK/WHITE	4	16746	
TAN/WHITE	2	16747	
	4	16743	



BARR'S™

SLUMP BUSTER BRASS CONE

COLOR	SIZE	CODE	J
SILVER CONE/BLACK	4	13583	
	6	13586	
	8	13587	
	10	13588	
	12	13589	
GOLD CONE/NATURAL	4	13536	
	6	13537	
GOLD CONE/OLIVE	8	13538	
	10	13539	
	12	13540	
COPPER CONE/RUST	4	13545	
	6	13542	
	8	13543	
COPPER CONE/RUST	10	13544	
	12	13541	



MURDICH'S™

MURDICH™ MINNOW HC

COLOR	SIZE	CODE	H*
CHARTREUSE/WHITE	1/0	10800	
COPPER/WHITE	1/0	19497	
COPPER/YELLOW	1/0	70220	
GOLD/WHITE	1/0	19498	
GREY/WHITE	1/0	10804	



MURDICH'S™

MURDICH™ WIGGLER

COLOR	SIZE	CODE	F*
BLACK	2	18105	
ROOT BEER	2	18107	
TAN	2	18108	
WHITE	2	18109	



NEAR NUFF SCULPIN

COLOR	SIZE	CODE	G
OLIVE	4	10231	
	6	10232	
	8	10233	
TAN	4	10227	
	6	10228	
	8	10229	



SCHRANTZ'S™

PLATTE RIVER SPIDER

COLOR	SIZE	CODE	H
	4	13351	

NEW



EGAN'S™

POACHER

COLOR	SIZE	CODE	H
BLACK	08	74335	
	10	74336	
	12	74337	
OLIVE	08	74338	
	10	74339	
	12	74340	



SILVEY'S™

SCULPIN LEECH

COLOR	SIZE	CODE	KK
BLACK	4	SIG0454	
OLIVE	4	SIG0456	
TAN	4	SIG0457	



HICKMAN'S™

SKIDDISH SMOLT BRASS CONE

COLOR	SIZE	CODE	K
BROWN	4	SIG2127	
NATURAL	4	SIG1062	
OLIVE	4	SIG2128	

NEW



WHITE'S™

SLG MINNOW

COLOR	SIZE	CODE	F*
BLK/PURPLE	01	74253	
CHARTREUSE	01	74254	
RAINBOW	01	74255	
WHITE	01	74256	
YELLOW	01	74257	



MENA'S™

SLIDER BUGGER

COLOR	SIZE	CODE	K
WHITE	02	73226	
BLACK	02	73227	
OLIVE/ GINGER	02	73228	
BROWN/ YELLOW	02	73229	



WINKLER'S™

SPARRING PARTNER

COLOR	SIZE	CODE	J
BLACK/ PURPLE	04	73239	
	06	73240	
WHITE/ GOLD	04	73242	
	06	73243	
BROWN TROUT	04	73245	
	06	73246	



CRAVEN'S™

SWIM COACH

COLOR	SIZE	CODE	I*
BROWN/YELLOW	2x4	73065	
GRAY	2x4	73063	
OLIVE	2x4	73064	
PURPLE/BLACK	2x4	73062	



CRAVEN'S™

SWIM COACH BABY

COLOR	SIZE	CODE	L
BROWN/YELLOW	4x6	73069	
GRAY	4x6	73067	
OLIVE	4x6	73068	
PURPLE/BLACK	4x6	73066	

STREAMERS



TAKAHASHI'S™

TAK'S MINI MINNOW

COLOR	SIZE	CODE	G
OLIVE/WHITE	8	70213	
RAINBOW	8	70214	



BOYER'S™

TODD'S WIGGLE MINNOW

COLOR	SIZE	CODE
BAITFISH	HC 2/0	10067 H*
BROWN TROUT	2	10046 G*
	6	10047 G*
CHARTREUSE	HC 2/0	10068 H*
FIRE TIGER	2	10048 G*
	6	10049 G*
RAINBOW TROUT	2	10055 G*
	6	10056 G*
RED/WHITE	HC 2/0	10069 H*
SHAD	2	10057 G*
	6	10058 G*
WHITE	2	10059 G*
	6	10066 G*



GINOP'S™

WEDGE HEAD STREAMER

COLOR	SIZE	CODE	KK*
BLACK	2/0	71408	
BROWN	2/0	73088	
OLIVE	2/0	71409	
WHITE	2/0	71410	



OLCH'S™

WIGGLE LEMMING

COLOR	SIZE	CODE	K*
TAN	2	16617	



ZIRDLE BUG JIG TUNGSTEN BEAD

COLOR	SIZE	CODE	I
OLIVE/BROWN	8	73076	
	10	73077	
	12	73078	
ORANGE/NATURAL	8	73073	
	10	73074	
	12	73075	
ORANGE/OLIVE	8	73070	
	10	73071	
	12	73072	



ZONKER

COLOR	SIZE	CODE	F
NATURAL/COPPER	4	16302	
	6	16303	
NATURAL/PEARL	4	16310	
	6	16311	
	8	16312	
OLIVE	4	16318	
	6	16319	
	8	16320	
WHITE/PEARL	4	16334	
	6	16335	
	8	16336	



FRESHWATER FLYS
LEADER & TIPPET
PACKS & BAGS
ACCESSORIES
HOOKS
TOOLS & KITS
TYING MATERIALS
NECKS & SADDLES



JOURNAL

**STEELHEAD &
ALASKA/PNW**

163



2-SALT TUBE

COLOR	SIZE	CODE	H*
BLUE/ BLACK	04	74001	
PURPLE/ PINK	04	73999	
BLACK/ BLUE	04	74000	
BLACK/ RED	04	74002	



BANTAM

COLOR	SIZE	CODE	I
BLACK/BLUE	2"	SIG1475	
GREEN BUTT	2"	SIG1590	



HOGAN'S™

BLACK & ORANGE

COLOR	SIZE	CODE	DD*
	03	73504	
	05	73505	



HOGAN'S™

BLACK DRESS

COLOR	SIZE	CODE	D*
	03	73506	
	05	73507	



BORDEN SPECIAL

COLOR	SIZE	CODE	DD
	6	SIG0002	



BUNNY LEECH

COLOR	SIZE	CODE	D
BLACK	6	13303	
OLIVE	6	13315	



HOGAN'S™

DC PRAWN

COLOR	SIZE	CODE	G*
BLACK/ ORANGE 3"		73508	



HICKMAN'S™

FISH TACO

COLOR	SIZE	CODE	J
BLACK	2.5"	SIG1052	
PINK	2.5"	SIG1053	
PURPLE	2.5"	SIG1054	



GREEN BUTT SILVER HILTON

COLOR	SIZE	CODE	E
	4	STL0028	
	6	STL0029	



GREEN BUTT SKUNK

COLOR	SIZE	CODE	I
	3	STL0225	
	5	STL0226	

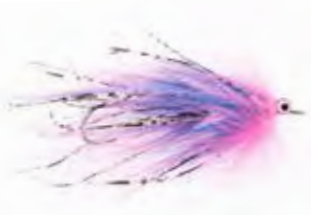

ORTIZ'S™

HALF-MAN INTRUDER

COLOR	SIZE	CODE	K*
BLUE/ CHART	1/0	73531	
PINK/ BLUE	1/0	73532	



WATTS™

KILOWATT

COLOR	SIZE	CODE	K
BLACK/BLUE	1/0	16304	



HOGAN'S™

MAHONY

COLOR	SIZE	CODE	H*
	1.5"	73510	
	3"	73509	



HOGAN'S™

MR SILVEY

COLOR	SIZE	CODE	G*
BLACK/ GREEN	03	73511	
	05	73512	



OCTOBER HILTON

COLOR	SIZE	CODE	I
	5	SIG1578	



HIERONYMUS™

PARTY GIRL

COLOR	SIZE	CODE	L*
PINK	2	70279	



SCHRANTZ'S™

PLATTE RIVER SPIDER

COLOR	SIZE	CODE	H
	4	13351	



MILLS'S™

THE ROADRUNNER

COLOR	SIZE	CODE	G*
NTRL/ ORG	1/0	73528	

SPEY FLIES



SCANDI CANDY

COLOR	SIZE	CODE	I*
BLUE	#4	74020	
CHARTREUSE	#4	74021	
ORANGE	#4	74022	



HICKMAN'S™

SKIDDISH SMOLT BRASS CONE

COLOR	SIZE	CODE	K
BROWN	4	SIG2127	
NATURAL	4	SIG1062	
OLIVE	4	SIG2128	



HOWARD'S™

TAIL DRAGGER TUBE

COLOR	SIZE	CODE	E*
BLACK	04	73517	
BLACK/ ORANGE	04	73518	
PURPLE/ PINK	04	73519	



TUBE SKATER

COLOR	SIZE	CODE	D*
BLACK/ PINK	06	74025	
OCT CADDIS	06	74026	



SILI-SQUID INTRUDER

COLOR	SIZE	CODE	I*
BLACK/ BLUE	02	73537	
BLUE/ CHART	02	73538	
PINK/ ORG	02	73539	
PINK/ BLACK	02	73540	



MILLS™

THE STUDLER

COLOR	SIZE	CODE	J6
BLACK/ BLUE	1/0	73529	
NATURAL/ORG	1/0	73530	



TIDE RIDER

COLOR	SIZE	CODE	E*
BROWN	6	71140	
OLIVE	6	71141	



HOWARD'S™

WINTER'S HOPE 451

COLOR	SIZE	CODE	F*
	1.5	73520	
	3/0	73521	



SILVEY'S™

SILVEY INTRUDER

COLOR	SIZE	CODE	I*
BLACK	02	73533	
BLACK/ BLUE	02	73534	
ORANGE	02	73535	
PURPLE/ PINK	02	73536	



HOWARD'S™

SUMMER IRON

COLOR	SIZE	CODE	F*
BK BEAR BRIGHT	03	73513	
BULKLEY BLUE	03	73514	
ER FLY	03	73515	
GRN FLATLANDER	03	73516	



THALKEN'S™

TINY DANCER

COLOR	SIZE	CODE	I
OCTOBER CADDIS	7	70262	



SILVEY'S™

SILVEYNATOR BRASS BEAD

COLOR	SIZE	CODE	H
BLUE	TUBE	SIG1832	
ORANGE	TUBE	SIG1833	



ANDREW'S™

BEAR'S CROSSDRESSER

COLOR	SIZE	CODE	F
FRY	4	14163	



ANDREW'S™

BEAR'S SADDLEBACK HEX

COLOR	SIZE	CODE	F
YELLOW	6	17871	



HIERONYMUS™

CHOKER

COLOR	SIZE	CODE	I
FLESH	6	70292	



**DEEP OCTOBER PUPA
BRASS BEAD**

COLOR	SIZE	CODE	G
	6	SIG0025	
	8	SIG0026	



PILGREEN'S™

**DOLLY LLAMA
BRASS CONE**

COLOR	SIZE	CODE	I
BLACK/WHITE	2	19873	
CHARTREUSE/PINK	2	19875	
DARK OLIVE/WHITE	2	19879	
WHITE	2	19880	
FLESH/CREAM	2	19876	
HOT PINK/PURPLE	2	19877	
OLIVE/WHITE	2	19878	



PILGREEN'S™

**DOLLY LLAMA MINI
BRASS CONE**

COLOR	SIZE	CODE	I
BLACK/OLIVE	2	72067	
BLACK/WHITE	2	72068	
OLIVE/WHITE	2	72070	
DARK OLIVE/WHITE	2	72071	
WHITE	2	72072	



PILGREEN'S™

**DOLLY LLAMA WITH EGG
BRASS CONE**

COLOR	SIZE	CODE	I
DARK OLIVE/WHITE	2	19883	
BLACK/WHITE	2	19881	
FLESH/CREAM	2	19882	



EGG SUCKING CRYSTAL LEECH

COLOR	SIZE	CODE	DD
BLACK	4	13409	
PURPLE	4	13414	



EGG SUCKING LEECH

COLOR	SIZE	CODE	DD
BLACK	4	23000	
PURPLE	4	23002	



FLESH FLY

COLOR	SIZE	CODE	D
CREAM	4	15206	



BARR'S™

MEAT WHISTLE BRASS CONE

COLOR	SIZE	CODE	G*
BLACK	2	10701	
	1/0	10840	
CHARTREUSE	2	10704	
	1/0	10697	
CRAWDAD	2	10702	
	1/0	10844	
OLIVE	2	10703	
	1/0	10842	
VIRILE CRAYFISH	2	10695	
	1/0	10694	
WHITE	2	10705	
	1/0	10699	



MURDICH'S™

MURDICH™ WIGGLER

COLOR	SIZE	CODE	F*
BLACK	2	18105	
ROOTBEER	2	18107	
TAN	2	18108	
WHITE	2	18109	



OCTOBER CADDIS ADULT

COLOR	SIZE	CODE	F
	8	SIG0111	



MERCER'S™

RAG HEX

COLOR	SIZE	CODE	J
YELLOW	8	18184	



BARR'S™

**RUBBERLEG COPPER JOHN
STEELHEAD BRASS BEAD**

COLOR	SIZE	CODE	I
BLACK	10	71335	
BLUE	10	71336	
COPPER	10	71337	
RED	10	71338	



STEELHEAD BUGGER

COLOR	SIZE	CODE	E
BLACK	6	17875	



HIERONYMUS™

TWOFER

COLOR	SIZE	CODE	F
CREAM	6	70308	
FLESH	6	70309	
PEACH	6	70310	

STEELHEAD, SALMON, ALASKA



FRESHWATER FLYS

LEADER & TIPPET

PACKS & BAGS

ACCESSORIES

HOOKS

TOOLS & KITS

TYING MATERIALS

NECKS & SADDLES

PHOTO: WESLEY WHITE

WG Flies have weed guards. **HLB** Flies are packaged with a header card. Price codes accompanied by (*) indicate a quantity of 6. Colors in the name indicate which color is shown.
PRICE CODES A\$12.60 B\$15.00 C\$17.70 D\$20.10 DD\$22.50 E\$24.00 F\$27.30 G\$29.70 H\$33.30 I\$37.50 J\$42.00 K\$48.00 KK\$57.00 LL\$70.00 M\$79.50



ARMSTRONG'S™

HOOD RAT ARTICULATED

COLOR	SIZE	CODE	L
	04	72325	



CHICONE'S™

KING RAT SMALL WG

COLOR	SIZE	CODE	K*
	1	72089	



LOCO MOUSE

COLOR	SIZE	CODE	F*
NATURAL	6	10062	



HICKMAN'S™

MINI HANKEY

COLOR	SIZE	CODE	K
	4	SIG1772	



MINI MOUSE WG

COLOR	SIZE	CODE	E*
NATURAL	10	10536	



MOUSERAT WG

COLOR	SIZE	CODE	F*
BLACK	6	10535	
NATURAL	6	10534	
	10	10538	



HICKMAN'S™

MR. HANKEY

COLOR	SIZE	CODE	K
	4	SIG1058	



JANSEN'S™

TECHNO-WOG

COLOR	SIZE	CODE	I
PINK	1/0	17918	



WAKING MOUSE

COLOR	SIZE	CODE	L
	4	SIG0112	
	6	SIG1505	



WAKING MOUSE 2.0

COLOR	SIZE	CODE	KK
	2	SIG2266	



OLCH'S™

WIGGLE LEMMING

COLOR	SIZE	CODE	K*
	2	16617	

WAKING FLIES

FRESHWATER FLIES



WG Flies have weed guards. **HC** Flies are packaged with a header card. Price codes accompanied by (*) indicate a quantity of 6. Colors in bold/italic indicate which color is shown.
PRICE CODES **A**\$12.60 **B**\$15.00 **C**\$17.70 **D**\$20.10 **DD**\$22.50 **E**\$24.00 **F**\$27.30 **G**\$29.70 **H**\$33.30 **I**\$37.50 **J**\$42.00 **K**\$48.90 **KK**\$57.30 **L**\$70.50 **M**\$79.50



SALTWATER

- SALTWATER FLATS
- SALTWATER BLUEFISH & STRIPERS
- SALTWATER TARPON
- SALTWATER POPPERS & SLIDERS
- ALL PURPOSE SALTWATER

SALTWATER FLIES

LEADER & TIPPET

PACKS & BAGS

ACCESSORIES

HOOKS

TOOLS & KITS

TYING MATERIALS

NECKS & SADDLES

UMPQUA
www.umpqua.com

SALTWATER



DECEIVER HD
BIG GAME FLUORO PINK

16LB
7.3KG
25YD
23.0M
0.015" ϕ 3.3mm



SALTWATER FLATS



173



GERBEC'S™

ALPHLEXO CRAB

COLOR	SIZE	CODE	J*
OLIVE	2	72652	
	6	73101	
TAN	2	72651	
	6	73100	
WHITE	2	72650	



AVALON PERMIT FLY

COLOR	SIZE	CODE	E*
TAN HEAVYWEIGHT	2	SWF0381	
TAN LIGHTWEIGHT	2	SWF0382	



JANIK'S™

BLIND FAITH MERKWAN wg

COLOR	SIZE	CODE	J
MIDNIGHT	4	72982	
NATURAL	4	72981	

NEW



HOCHNER'S™

BOOBIE CRAB

COLOR	SIZE	CODE	I*
AMBER	01	74230	
OLIVE	01	74231	
TAN	01	74232	



CHICONE'S™

**BONE APPETITE
BEAD CHAIN**

COLOR	SIZE	CODE	G
PINK	4	70937	
TAN	4	70939	



MATHEWS™

BONEFISH BITTERS

COLOR	SIZE	CODE	H
AMBER	6	18268	
	8	18269	
OLIVE	6	18206	
	8	18207	



BONEFISH DEEP MINNOW

COLOR	SIZE	CODE	H
FOXEE RED	2	18456	
	4	18457	



CRAVEN'S™

**BONEFISH JUNK
BEAD CHAIN**

COLOR	SIZE	CODE	K
LIGHT	4	70057	
	6	70058	



COWEN'S™

**BONEFISH SCAMPI
BEAD CHAIN**

COLOR	SIZE	CODE	G
PINK	4	15371	
	6	15380	
BARRED TAN	4	19724	
	6	19725	



COWEN'S™

**BONEFISH SCAMPI
LEAD EYE**

COLOR	SIZE	CODE	G
PINK	4	15292	
TAN	2	15285	
	4	15286	



BONEFISH SLIDER wg

COLOR	SIZE	CODE	DD*
BROWN	4	15257	
	6	15258	
CHARTREUSE	4	15080	



BUNNY GOTCHA

COLOR	SIZE	CODE	F
TAN/PINK	6	18462	



VEVERKA'S™

CAPTAIN CRABBY

COLOR	SIZE	CODE	H*
TAN	4	15201	



HOCHNER'S™

CAPTAIN GREGG

COLOR	SIZE	CODE	I*
TAN/PURPLE	2	70961	
	4	70962	



BECK'S™

CATHY'S FLEEING CRAB

COLOR	SIZE	CODE	DD*
TAN	2	16630	
	4	16631	
	6	16632	



CHERNOBYL CRAB wg

COLOR	SIZE	CODE	F*
	2	15253	

NEW



CHOUINARD'S™

CHEWY'S BENDER

COLOR	SIZE	CODE	I*
BLK/PURP	01	74452	
	02	74453	
BLK/PURP WTD	01	74454	
	02	74455	
CHART/WHT	01	74456	
	02	74457	
CHART/WHT WTD	01	74458	
	02	74459	
OLV/TAN	01	74448	
	02	74449	
OLV/TAN WTD	01	74450	
	02	74451	
WHITE	01	74460	
	02	74461	
WHITE WTD	01	74462	
	02	74463	

NEW



CHOUINARD'S™

CHEWY'S CHEWCEIVER

COLOR	SIZE	CODE	I*
HONEY	04	74442	
	06	74443	
	08	74444	
WHITE	04	74439	
	06	74440	
	08	74441	

FLATS



CHOUINARD'S™

CHEWY'S CYBORG SHRIMP

COLOR	SIZE	CODE	M
OLIVE	02	73560	
	04	73561	
	06	73562	
PINK/ TAN	02	73563	
	04	73564	
	06	73565	
WHITE	02	73566	
	04	73567	
	06	73568	



CHOUINARD'S™

CHEWY'S ISLAND TIME

COLOR	SIZE	CODE	K
TAN/ ORANGE	01	73597	
	02	73598	
	04	73599	
	06	73600	



KAUFMANN'S™

CHRISTMAS ISLAND SPECIAL

COLOR	SIZE	CODE	G
ORANGE	6	15149	
	8	15150	
PEARL	6	15161	
	8	15162	
PINK	6	15157	
	8	15158	



CHOUINARD'S™

CHEWY'S CYLOPS

COLOR	SIZE	CODE	K
BONEFISH/ TAN	04	73570	
	06	73571	
	08	73572	
GHOSTLUCENT	04	73574	
	06	73575	
	08	73576	



CHOUINARD'S™

CHEWY'S HALO SHRIMP

COLOR	SIZE	CODE	L
CHARTREUSE	04	73578	
	06	73579	
	08	73580	
GRIZZLY	04	73582	
	06	73583	
	08	73584	
OLIVE	04	73586	
	06	73587	
	08	73588	
TAN	04	73590	
	06	73591	
	08	73592	
WHITE	04	73594	
	06	73595	
	08	73596	



CHOUINARD'S™

CHEWY'S MINNR

COLOR	SIZE	CODE	K
CHART/ TAN	02	73601	
	04	73602	
	06	73603	
OLIVE/ TAN	02	73604	
	04	73605	
	06	73606	
PINK/ TAN	02	73607	
	04	73608	
	06	73609	
TAN	02	73610	
	04	73611	
	06	73612	
WHITE	02	73613	
	04	73614	
	06	73615	



CHOUINARD'S™

CHEWY'S MORSEL

COLOR	SIZE	CODE	L
COYOTE	01	73616	
	02	73617	
	04	73618	
	06	73619	
PINK	01	73620	
	02	73621	
	04	73622	
	06	73623	
RED FOX	01	73624	
	02	73625	
	04	73626	
	06	73627	



CHICONE'S™

CONTRABAND CRAB

COLOR	SIZE	CODE	G*
DARK BROWN	4	70967	
OLIVE	4	70968	
TAN	4	70969	



CHICONE'S™

COYOTE SPAWN SHRIMP w6

COLOR	SIZE	CODE	I*
TAN/ORANGE	4	70970	
	6	70971	



CHICONE'S™

COYOTE SHRIMP w6

COLOR	SIZE	CODE	I*
TAN	4	70972	
	6	70973	



BAUER'S™

CRAFTY SHRIMP

COLOR	SIZE	CODE	
BEAD CHAIN	4	17015	DD*
LEAD EYE	4	17069	E*



CRAZY CHARLIE BEAD CHAIN

COLOR	SIZE	CODE	E
PINK	4	15307	
	6	15308	
	8	15340	
TAN	4	15303	
	6	15304	
	8	15336	



MCKNIGHT'S™

CRIMP

COLOR	SIZE	CODE	I*
MERKIN BROWN	4	15315	
TAN	4	15316	



MCKNIGHT'S™

DANGER MUFFIN CRAB

COLOR	SIZE	CODE	J*
GHOST TAN	02	73262	
	04	73263	
	06	73264	
GOLD BROWN	02	73265	
	04	73266	
	06	73267	
SANDY OLIVE	02	73268	
	04	73269	
	06	73270	



HOCHNER'S™

DIRTY HAIRY

COLOR	SIZE	CODE	H*
CHARTREUSE	02	73112	
PURPLE	02	73113	
TAN	02	73114	



CHICONE'S™

DISCO SHRIMP

COLOR	SIZE	CODE	I*
TAN	2	70992	
	4	70993	



DAVIS™

DRUM BEATER hc

COLOR	SIZE	CODE	F*
BLACK/CHARTREUSE	2	70352	
BLACK/PURPLE	2	70353	
OLIVE/PINK	2	70354	
TAN/ORANGE	2	70355	



PANZARELLA'S™

ELECTRIC SLIDER

COLOR	SIZE	CODE	KK
BLACK	02	73632	
BLACK	1/0	73633	



MCKNIGHT'S™

ER CRAB w6

COLOR	SIZE	CODE	F*
OLIVE	2	70061	
	6	70062	
TAN	2	70063	
	6	70064	



JANIK'S™

FIGHT N FLEE FIDDLER

COLOR	SIZE	CODE	KK
MIDNIGHT	4	72980	
NATURAL	4	72979	



PANZARELLA'S™

FLASHBACK SHRIMP

COLOR	SIZE	CODE	M
TAN/ ORANGE	02	73634	



FLATS CRAB

COLOR	SIZE	CODE	G*
LIGHT OLIVE	4	15528	
	6	15543	
TAN	4	15529	
	6	15544	



FLATS CRAB MOTTLED w6

COLOR	SIZE	CODE	G*
LIGHT OLIVE	4	72956	
	6	72957	



VEVERKA'S™

GHOST SHRIMP BEAD CHAIN

COLOR	SIZE	CODE	I
TAN	4	70207	
	6	70208	

FLATS

NEW



GLADES MINNOW HC

COLOR	SIZE	CODE	G*
OLIVE/GRAY	2	15068	



IMPROVED MERKIN

COLOR	SIZE	CODE	G*
BROWN/TAN NO WG	2	72657	
	4	72658	
TAN/SAND NO WG	2	72660	
	4	72661	
OLIVE/TAN NO WG	2	72663	
	4	72664	



MAGNUM MANTIS

COLOR	SIZE	CODE	J*
BROWN	01	74241	
CHARTREUSE	01	74242	
ORANGE	01	74240	
TAN	01	74239	



MCCRAB

COLOR	SIZE	CODE	I*
	2	15349	



GOTCHA BEAD CHAIN

COLOR	SIZE	CODE	E
PEARL	2	18463	
	4	18464	
	6	18465	
	8	18466	



KUNG FU CRAB wg

COLOR	SIZE	CODE	H*
OLIVE/TAN	2	10336	
	4	10337	
TAN	2	10338	
	4	10339	

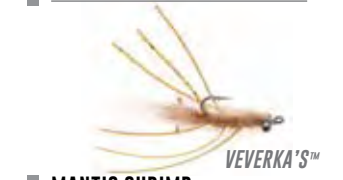

MANTIS SHRIMP BEAD CHAIN

COLOR	SIZE	CODE	G
OLIVE	2	72933	
	4	72934	
	6	72935	
	8	72936	
TAN	2	15669	
	4	15670	
	6	15671	
	8	15672	
OLIVE WG	2	72937	
	4	72938	
	6	72939	
	8	72940	
TAN WG	2	72924	
	4	72925	
	6	72926	
	8	72927	



MIDNIGHT MINNOW HC

COLOR	SIZE	CODE	DD*
	6	19480	



GOTCHA BEAD CHAIN WG

COLOR	SIZE	CODE	E
PINK	4	23921	
	6	23922	
TAN/PEARL	4	23927	
	6	23928	



KWAN BEAD CHAIN WG

COLOR	SIZE	CODE	H
TAN	4	17670	
	6	17671	



MAYHEM MOLE CRAB

COLOR	SIZE	CODE	K*
GHOST	02	73547	
OLIVE	02	73548	
TAN	02	74236	



MIDNIGHT MULLET HC

COLOR	SIZE	CODE	G*
	1/0	19500	



GUMMY MINNOW HC

COLOR	SIZE	CODE	
BLUE	2	15752	J*
	6	15753	H*
BROWN	2	15086	J*
	6	15620	H*
CHARTREUSE	2	16170	J*
	6	16171	H*
CLEAR	6	15021	H*
GREEN	2	15087	J*
	6	15089	H*
PEARL	2	15088	J*
	6	15619	H*



LASER MINNOW

COLOR	SIZE	CODE	DD
GRAY/PINK	02	73635	

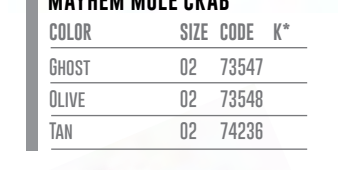

MAYPORT SELECT SHRIMP wg

COLOR	SIZE	CODE	J
MIDNIGHT	4	72984	
SAND	4	72985	



MURDICH™ WIGGLER

COLOR	SIZE	CODE	F*
BLACK	2	18105	
ROOTBEER	2	18107	
TAN	2	18108	
WHITE	2	18109	



LEXO'S POP UP CRAB wg

COLOR	SIZE	CODE	J*
BLUE CRAB	2	70733	
	4	70734	



NIGHTMARE NEEDLE FISH

COLOR	SIZE	CODE	L*
	2/0-2	72887	

WG Flies have weed guards. HC Flies are packaged with a header card. Price codes accompanied by (*) indicate a quantity of 6. Colors in bold/italic indicate which color is shown. PRICE CODES A\$12.60 B\$15.00 C\$17.70 D\$20.10 DD\$22.50 E\$24.00 F\$27.30 G\$29.70 H\$33.30 I\$37.50 J\$42.00 K\$48.90 KK\$57.30 L\$70.50 M\$79.50

SALTWATER FLIES
LEADER & TIPPET
PACKS & BAGS
ACCESSORIES
HOOKS
TOOLS & KITS
TYING MATERIALS
NECKS & SADDLES



HOCHNER'S™

ONE ARMED BANDIT wg

COLOR	SIZE	CODE	J*
SAND	2	72647	
BROWN	2	72648	



DEL BROWN'S™

PERMIT CRAB

COLOR	SIZE	CODE	G*
TAN/BROWN	1/0	15406	
	2	15407	
	4	15400	



HOCHNER'S™

PERMINATOR

COLOR	SIZE	CODE	I*
GHOST CRAB	02	73108	
MUD CRAB	02	73109	
BLUE CRAB	02	73110	



GERBEC'S™

PO BOY

COLOR	SIZE	CODE	J*
BROWN/TAN	2/0	72994	
	02	72995	
CHARTREUSE/WHITE2/0	02	72992	
	02	72993	
PURPLE/BLACK	2/0	72996	
	02	72997	



GERBEC'S™

POLAR PRAWN

COLOR	SIZE	CODE	I
TAN	04	73106	



RAG HEAD CRAB

COLOR	SIZE	CODE	F*
TAN	2	18177	
	4	18178	
	6	18179	
OLIVE	2	72963	
	4	72964	
	6	72965	



RASTA PUFF BEAD CHAIN MCKNIGHT'S™

COLOR	SIZE	CODE	F
PINK	6	17555	



COWEN'S™

REDFISH SCAMPI

COLOR	SIZE	CODE	H
TAN	1	72665	
	4	72666	
RUST	1	72667	
	4	72668	

NEW



COWEN'S™

REDFISH SCAMPI BC

COLOR	SIZE	CODE	F
RUST	01	74243	
	04	74244	
TAN	01	74245	
	04	74246	



MORET'S™

SANDY'S CRACKED CRAB wg

COLOR	SIZE	CODE	DD*
	2	15415	
	4	15416	



BECK'S™

SILI LEGS

COLOR	SIZE	CODE	J
TAN	4	17680	
	6	17681	



BECK'S™

SILI LEGS LITE BEAD CHAIN

COLOR	SIZE	CODE	J
TAN	4	70669	
	6	70670	

NEW



MCGOVNEY'S™

SIMPLE CRAB

COLOR	SIZE	CODE	F*
LT OLIVE	04	74247	
	08	74248	
OLV/BROWN	04	74249	
	08	74250	
TAN	04	74251	
	08	74252	



SKINNY WATER CLOUSER MINNOW hc

COLOR	SIZE	CODE	F
CHARTREUSE/WHITE	4	16749	
	6	16739	
GRAY/WHITE	6	16742	
PINK/WHITE	4	16746	
TAN/WHITE	4	16743	



VEVERKA'S™

SPAWNING MANTIS

COLOR	SIZE	CODE	I
TAN/ORANGE	2	70210	
	4	70211	
	6	70212	



SQUIMP

COLOR	SIZE	CODE	F
TAN	2	72100	
	4	72101	
	6	15166	
	8	15167	



SKOK'S™

STRONG ARM MERKIN

COLOR	SIZE	CODE	I*
TAN	LT 02	73092	
	MED 02	73093	
OLIVE	LT 02	73094	
	MED 02	73095	
WHITE	LT 02	73090	
	MED 02	73091	

FLATS



HAINES™

SUPREME HAIR SHRIMP

COLOR	SIZE	CODE	G*
OLIVE	2	70878	
	6	70879	
TAN	2	15255	
	6	15256	
WHITE	2	70880	
	6	70881	



WESTSIDE

COLOR	SIZE	CODE	E*
	4	SIG1603	



YANKANICH'S™

YANK'S™ ASSASSIN HC

COLOR	SIZE	CODE	I*
REDFISH	2	17590	



JANIK'S™

SWISS ARMY SLIDER wg

COLOR	SIZE	CODE	J
MIDNIGHT	4	72987	
NATURAL	4	72986	
SAND		72985	



CHICONE'S™

TIDE SLAVE

COLOR	SIZE	CODE	I*
TAN/ ORANGE	2	71144	
	4	71145	



TRIPLE THREAT FLATS

COLOR	SIZE	CODE	F*
	2	15348	



ULTRA SHRIMP

COLOR	SIZE	CODE	F*
TAN	4	15611	
	1/0	15609	



SALTWATER FLYS

LEADER & TIPPET

PACKS & BAGS

ACCESSORIES

HOOKS

TOOLS & KITS

TYING MATERIALS

NECKS & SADDLES



UMPQUA
www.umpqua.com
PERFORM X HD

UMPQUA
www.umpqua.com

PERFORM X HD
NYLON



STRIPER LEADER

12LB
5.4kg

UMPQUA
www.umpqua.com
SALTWATER
DECEIVER HD
BIG GAME FLUORO PINK
0.012" / 0.31"

SALTWATER BLUEFISH & STRIPERS



181



Clouser Minnow

COLOR	SIZE	CODE
BLACK	2/0	15110 H
	2	15111 G
	6	15112 G
BLUE/WHITE	2/0	16720 H
	2	16721 G
	6	16722 G
CHARTREUSE/WHITE	2/0	16750 H
	2	16751 G
	4	16726 G
CHARTREUSE/YELLOW	2	15116 G
	6	15117 G
	CRABBY	2
	6	17146 G
FOXEE RED	6	16776 G
GOLDEN SHINER	2	16766 G
	6	16767 G
OLIVE/WHITE	2/0	16723 H
	2	16724 G
	6	16725 G
	PINK/WHITE	2/0
2		17142 G
	6	17143 G
	RED/WHITE	2/0
2		15121 G
	6	15122 G
	SCULPIN	2
6		16757 G
SEXY SHAD	2/0	19963 H
	2	19964 G
	6	19965 G
	SILVER SHINER	2/0
2		16761 G
	6	16762 G
	TUTTI FRUITI	2/0
2		16138 G
	6	16139 G
	WHITE	2/0
2		15272 G
	6	15273 G



Cowen's™ Baitfish hc

COLOR	SIZE	CODE	I*
CHARTREUSE/WHITE	1/0	16030	
OLIVE/LAV/WHITE	1/0	19158	



Coyote hc

COLOR	SIZE	CODE	I*
BLUE/CHART/WHITE	1	18281	
CHARTREUSE/WHITE	1	18273	



Crease Fly hc

COLOR	SIZE	CODE	I*
BLACK BACK	1/0	16706	
	3/0	16705	
BLUE BACK	1/0	17755	
	3/0	17754	
FIRE TIGER	1/0	16704	
OLIVE BACK	1/0	17751	
	3/0	17750	
SILVER	1/0	16717	
	3/0	16716	



Cruiser hc

COLOR	SIZE	CODE	M*
BLACK/PURPLE	3/0	70868	
CHARTREUSE/WHITE	2/0	18821	
SARDINA	2/0	18823	
SHAD	2/0	18826	



Deceiver hc

COLOR	SIZE	CODE	D*
BLACK	2/0	15468	
CHARTREUSE/WHITE	4/0	15472	
	2/0	15471	
	1/0	15470	
	2	15469	
	RED/WHITE	2/0	15484
	1/0	15483	
	2	15482	
WHITE	4/0	15501	
	2/0	15500	
	1/0	15499	
	2	15498	
WHITE/BLUE	2/0	15508	
	1/0	15507	



Fishalicious

COLOR	SIZE	CODE	H*
CHARTREUSE/BLACK	1/0	19968	
OLIVE/BLACK/OLIVE	1/0	19970	
RED/WHITE	1/0	19971	

NEW



Flashtail Minnow Jig

COLOR	SIZE	CODE	H*
WHITE/PINK	1/0	71399	
	3/0	71398	
WHT/YLW/BRN	1/0	71401	
	3/0	71400	
WHT/YLW/CH/BL	1/0	71403	
	3/0	71402	



Flashtail Whistler hc

COLOR	SIZE	CODE	H*
ORANGE/YELLOW	3/0	15104	
RED/WHITE	3/0	15114	
RED/YELLOW	3/0	15119	



Banger hc

COLOR	SIZE	CODE	H*
CHARTREUSE	4/0	15383	
	2/0	15385	
SILVER	4/0	15382	
	2/0	15393	



Big Fish Deceiver hc

COLOR	SIZE	CODE	F*
BLUE/WHITE	3/0	15503	
CHARTREUSE/WHITE	3/0	15502	
OLIVE/WHITE	3/0	15504	



Captain Ray's Silversides hc

COLOR	SIZE	CODE	G*
SILVERSIDES	1/0	16503	

BLUEFISH & STRIPERS



GAME CHANGER HC (4.5" LENGTH)

COLOR	SIZE	CODE	L*
PEARL/WHITE	2/0	70313	
RAINBOW	2/0	70314	



ROBERTS' SM

GOOD FRIDAY SHAD

COLOR	SIZE	CODE	J
SHAD	06	73638	



GUMMY MINNOW HC

COLOR	SIZE	CODE	J*
BLUE	2	15752	J*
	6	15753	H*
BROWN	2	15086	J*
	6	15620	H*
CHARTREUSE	2	16170	J*
	6	16171	H*
CLEAR	6	15021	H*
GREEN	2	15087	J*
	6	15089	H*
PEARL	2	15088	J*
	6	15619	H*



GUMMY MINNOW BIG GAME HC

COLOR	SIZE	CODE	K*
PEARL	2	15023	



JERSEY TURNPIKE

COLOR	SIZE	CODE	E*
GLASS	6	71033	



KINTZ' SM

MAJOR BUNKER HC

COLOR	SIZE	CODE	L*
GRAY/BROWN	4/0	15408	



KINTZ' SM

MAJOR HERRING HC

COLOR	SIZE	CODE	L*
BLACK/BLUE/GRAY	3/0	10609	



KINTZ' SM

MAJOR MULLET HC

COLOR	SIZE	CODE	L*
BROWN/TAN/GRAY	3/0	10610	



CONNER'S SM

MIDNIGHT MINNOW HC

COLOR	SIZE	CODE	DD*
	6	19480	



CONNER'S SM

MIDNIGHT MULLET HC

COLOR	SIZE	CODE	G*
	1/0	19500	



MURDICH'S SM

MURDICH™ MINI MINNOW HC

COLOR	SIZE	CODE	H*
CHARTREUSE/WHITE	4	70889	
COPPER	4	70891	
COPPER/YELLOW	4	70893	
GOLD	4	70892	
GRAY/WHITE	4	70888	



MURDICH'S SM

MURDICH™ MINNOW HC

COLOR	SIZE	CODE	H*
CHARTREUSE/WHITE	1/0	10800	
COPPER/WHITE	1/0	19497	
COPPER/YELLOW	1/0	70220	
GOLD/WHITE	1/0	19498	
GRAY/WHITE	1/0	10804	



SKOK'S SM

MUSHMOUTH HC

COLOR	SIZE	CODE	I*
CHARTREUSE/WHITE	2/0	17620	
SAND/WHITE	2/0	17621	
BLUE/WHITE	2/0	17619	
YELLOW/WHITE	2/0	17622	



WG Flies have weed guards. HC Flies are packaged with a header card. Price codes accompanied by (*) indicate a quantity of 6. Colors in bold/italic indicate which color is shown.

PRICE CODES A\$12.60 B\$15.00 C\$17.70 D\$20.10 DD\$22.50 E\$24.00 F\$27.30 G\$29.70 H\$33.00 I\$37.50 J\$42.00 K\$48.90 KK\$57.30 L\$70.50 M\$79.50

SALTWATER FLIES
LEADER & TIPPET
PACKS & BAGS
ACCESSORIES
HOOKS
TOOLS & KITS
TYING MATERIALS
NECKS & SADDLES



MAYFIELD'S™

RATTLE MULLET HC

COLOR	SIZE	CODE	J*
CHARTREUSE/WHITE	2	10607	
OLIVE/WHITE	2	10605	



ANDERSON'S™

REDUCER

COLOR	SIZE	CODE	K*
PEACOCK	3/0	12461	
SHAD	1/0	19163	



SEA HABIT BUCKTAIL HC

COLOR	SIZE	CODE	H*
ANCHOVY	2/0	15245	
HERRING	2/0	15247	
SARDINE	2/0	15248	



SKOK'S™

MUSHMOUTH MINI

COLOR	SIZE	CODE	H*
CHARTREUSE/PEARL	1/0	71063	
PEACOCK/PEARL	1/0	71064	



VEVERKA'S™

SHINNECOCK SILVERSIDES

COLOR	SIZE	CODE	E*
	2	70520	
	4	70521	



ROBERTS'™

POP'S SHAD

COLOR	SIZE	CODE	K
SHAD	04	73636	
	06	73637	

NEW



ROBERT'S™

POP'S SHAD HD

COLOR	SIZE	CODE	E*
	1/0	74262	
	3/0	74261	



ANDERSON'S™

SPACE INVADER HC

COLOR	SIZE	CODE	K*
BLOOD BAIT	2/0	71123	
BUTTERFLY	2/0	71124	
NIGHT RIDER	2/0	71125	

BLUEFISH & STRIPERS



SURF CANDY HC

COLOR	SIZE	CODE	G*
LIME GREEN	1/0	15534	
LIGHT BLUE	1/0	15535	
OLIVE	1/0	15536	



WHITEBAIT MUSHY HC

COLOR	SIZE	CODE	F*
BAY ANCHOVY	2	16177	
CHARTREUSE/WHITE	2	16175	
SILVERSIDE	2	16176	
TUTTI FRUITI	2	16178	
WHITE	2	71172	



TIDE RIDER

COLOR	SIZE	CODE	E*
BROWN	6	71140	
OLIVE	6	71141	



YANK'S ASSASSIN HC

COLOR	SIZE	CODE	I*
REDFISH	2	17590	



BOYER'S™

TODD'S WIGGLE MINNOW HC

COLOR	SIZE	CODE	H*
BAITFISH	2/0	10067	
CHARTREUSE	2/0	10068	
RED/WHITE	2/0	10069	



CHICONE'S™

TUSCAN BUNNY HC

COLOR	SIZE	CODE	H*
BLACK/PURPLE	3/0	71162	



UMPQUA™ SWIMMING BAITFISH wg

COLOR	SIZE	CODE	J*
RED/WHITE	1/0	15571	
RED/YELLOW	1/0	15576	
SHAD	1/0	15585	
	4	15570	



SALTWATER FLYS

LEADER & TIPPET

PACKS & BAGS

ACCESSORIES

HOOKS

TOOLS & KITS

TYING MATERIALS

NECKS & SADDLES



SALTWATER TARPON

UMPQUA
www.umpqua.com

DECEIVER HD
FLUOROCARBON



UMPQUA
www.umpqua.com

40LB 18.1KG
25YD 23.0M
0.025\"/>A spool of Umpqua fishing line in a clear plastic case. The spool is black with a purple outer ring. The label on the spool reads: UMPQUA, 40LB 18.1KG, 25YD 23.0M, 0.025\" data-bbox="270 200 900 730"/>

SALTWATER



DECEIVER HD
BIG GAME FLUORO PINK
made in Japan



187



LEMAY'S™

BIG EYE TARPON HC

COLOR	SIZE	CODE	I*
BROWN	1/0	18141	
ORANGE/GRIZZLY	1/0	18137	
SAND DEVIL	1/0	18139	
YELLOW	1/0	18143	



LEMAY'S™

BLACK DEATH HC

COLOR	SIZE	CODE	E*
BLACK	3/0	18145	
	1/0	18146	



ALEXANDER'S™

BUMPIN' BUNNY

COLOR	SIZE	CODE	E*
BLACK	1/0	73642	
CHARTREUSE	1/0	73643	
WHITE	1/0	73644	



CHOUINARD'S™

CHEWY'S FIT FOR A KING

COLOR	SIZE	CODE	I*
BLACK	2/0	74446	
OLIVE	2/0	74447	
TAN	2/0	74445	



NEW

CHOUINARD'S™

CHEWY'S TARPONATOR

COLOR	SIZE	CODE	K*
BLK/PURP	2/0	74465	
OLIVE	2/0	74464	
PINK/TAN	2/0	74466	



ZIMMERMAN'S™

CHILI PEPPER WORM

COLOR	SIZE	CODE	G*
2.5" LENGTH	1	19869	
2" LENGTH	2	19870	



COCKROACH HC

COLOR	SIZE	CODE	F*
GRIZZLY/TAN	3/0	18149	
	1/0	19266	



BLANTON'S™

FLASHTAIL MINNOW JIG

COLOR	SIZE	CODE	H*
WHITE/PINK	1/0	71399	
	3/0	71398	
WHT/YLW/BRN	1/0	71401	
	3/0	71400	
WHT/YLW/CH/BL	1/0	71403	
	3/0	71402	



WHITE'S™

FOAM GUT MINNOW

COLOR	SIZE	CODE	F*
BLACK/ PURPLE	01	73639	
CHART/ FLYEL	01	73640	
WHITE/ RED	01	73641	



GUMMY MINNOW BIG GAME HC

COLOR	SIZE	CODE	K*
PEARL	2	15023	



TMC 600SP

GUMMY TARPON WORM HC

COLOR	SIZE	CODE	J*
	1/0	19271	



KEYS TOAD

COLOR	SIZE	CODE	G*
CHARTREUSE	2/OSM	73006	
PURPLE/BLACK	2/OSM	73008	
PURPLE/ BLACK WG	2/OLG	73009	



LAI-UP TARPON HC

COLOR	SIZE	CODE	G*
CHARTREUSE	1/0	18191	
TAN	1/0	18192	



STUDENT'S™

MEGALOPSICLE HC WG

COLOR	SIZE	CODE	H*
CHARTREUSE/YELLOW	1/0	15655	
DIRTY OLIVE	1/0	15656	
PURPLE/BLACK	1/0	15657	
TAN/ORANGE	1/0	15658	



NEW

CHICONE'S™

PEYOTE PALOLO

COLOR	SIZE	CODE	F
RED/OLIVE	1/0	73553	
	3/0	74432	



LEMAY'S™

PIKE/TARPON SNAKE HC

COLOR	SIZE	CODE	K*
BLACK	3/0	19256	
CHARTREUSE	3/0	19257	
ORANGE/YELLOW	3/0	19258	
RED/WHITE	3/0	19259	



CHICONE'S™

PUNISHER

COLOR	SIZE	CODE	F*
BLURPLE	2/0	73558	
CHART/WHT	2/0	73559	
KEY LIME	2/0	74263	
PINK/WHT	2/0	74237	
TAN/DRG	2/0	74238	



HAINES'S™

SUPREME HAIR RATTLE SHRIMP

COLOR	SIZE	CODE	J*
OLIVE	1	70876	
WHITE	1	70877	



MERRIMAN'S™

TARPON TOAD

COLOR	SIZE	CODE	F*
CHARTREUSE	1/0	10151	
PURPLE/BLACK	1/0	10152	
TAN	1/0	10153	
YELLOW	1/0	10154	
PEACH	1/0	73630	
RUST	1/0	73631	

TARPON



MERRIMAN'S™

TARPON TOAD II MARABOU TAIL

COLOR	SIZE	CODE	G*
CHARTREUSE	1/0	12940	
PURPLE/BLACK	1/0	12942	
RED/BLACK	1/0	12943	
YELLOW	1/0	12944	
CHART/ORG/CRM	1/0	73628	
PEACH	1/0	73629	



TRIPLE THREAT TARPON

COLOR	SIZE	CODE	F*
	1/0	15347	



BUMPIN' BUNNY BRANDON ALEXANDER

“The Bumpin Bunny is a small baitfish imitation that drives gamefish crazy. The fly serves as a perfect beach pattern that holds its own on the flats and in saltwater creeks.

The Bunny strip tail provides plenty of action without manipulation from the angler when presented to laid up snook or speckled trout. It also provides a panicked action when stripped quickly around ambush points.

Tie this fly on anytime a fleeing baitfish pattern needs to be presented.”

- Signature Tyer Brandon Alexander



POPPERS & SLIDERS



BANGER hc

COLOR	SIZE	CODE	H*
CHARTREUSE	4/0	15383	
	2/0	15385	
SILVER	4/0	15382	
	2/0	15393	



SALTWATER POPPER hc

COLOR	SIZE	CODE	G*
BLUE/WHITE	2/0	19140	
CHARTREUSE	2/0	19142	
RED/WHITE	2/0	19141	



BLADO'S™

CREASE FLY hc

COLOR	SIZE	CODE	I*
BLACK BACK	1/0	16706	
	3/0	16705	
BLUE BACK	1/0	17755	
	3/0	17754	
FIRE TIGER	1/0	16704	
OLIVE BACK	1/0	17751	
	3/0	17750	
SILVER	1/0	16717	
	3/0	16716	



BACHMANN'S™

SALTWATER POPPER DORADO hc

COLOR	SIZE	CODE	M*
GREEN/YELLOW	2/0	24392	



COWENS'S™

SOMETHIN ELSE

COLOR	SIZE	CODE	K
GRAY/ WHT	02	17310	
	04	17308	
OLIVE/ WHT	02	17311	
	04	17309	



CHICONE'S™

PINEAPPLE GRENADE POPPER

COLOR	SIZE	CODE	KK*
BLUE/ WHITE	2/0	73554	
CHART FROG	2/0	73555	
PINK/ WHITE	2/0	73556	
TAN/ WHITE	2/0	73557	



TEQUILA POPPER

COLOR	SIZE	CODE	G*
	1	SIG1601	



BOYER'S™

TODD'S WIGGLE MINNOW hc

COLOR	SIZE	CODE	H*
BAITFISH	2/0	10067	
CHARTREUSE	2/0	10068	
RED/WHITE	2/0	10069	



UMPQUA®

UMPQUA

ALL PURPOSE SALTWATER



193

NEW



WHITE'S™

AKOBE FLY

COLOR	SIZE	CODE	J*
BLACK/RED	06	73935	
WHITE/RED	06	73936	
YEL/CHART	06	73937	



CARANCI'S™

BAD ADDITUDE BAITFISH

COLOR	SIZE	CODE	L
BLACK/ RED	6/0	74035	
GRN/ ORG/ YEL	6/0	74036	
BLUE/RED/WHT	6/0	74039	
TAN/RD/ WHT	6/0	74038	



BIG FISH DECEIVER hc

COLOR	SIZE	CODE	F*
BLUE/WHITE	3/0	15503	
CHARTREUSE/WHITE	3/0	15502	
GRAY/WHITE	3/0	15504	



STACHELEK'S™

CAPTAIN RAY'S SILVERSIDES hc

COLOR	SIZE	CODE	G*
SILVERSIDES	1/0	16503	



CLOUSER MINNOW

COLOR	SIZE	CODE	
BLACK	2/0	15110 H	
	2	15111 G	
	6	15112 G	
BLUE/WHITE	2/0	16720 H	
	2	16721 G	
	6	16722 G	
CHARTREUSE/WHITE	2/0	16750 H	
	2	16751 G	
	4	16726 G	
	6	16752 G	
	CHARTREUSE/YELLOW	2	15116 G
		6	15117 G
CRABBY	2	17145 G	
	6	17146 G	
FOXEE RED	6	16776 G	
GOLDEN SHINER	2	16766 G	
	6	16767 G	
OLIVE/WHITE	2/0	16723 H	
	2	16724 G	
	6	16725 G	
PINK/WHITE	2/0	17141 H	
	2	17142 G	
	6	17143 G	
RED/WHITE	2/0	15120 H	
	2	15121 G	
	6	15122 G	
SCULPIN	2	16756 G	
	6	16757 G	
SEXY SHAD	2/0	19963 H	
	2	19964 G	
	6	19965 G	
SILVER SHINER	2/0	16760 H	
	2	16761 G	
	6	16762 G	
TUTTI FRUITI	2/0	16137 H	
	2	16138 G	
	6	16139 G	
WHITE	2/0	15271 H	
	2	15272 G	
	6	15273 G	



COWEN'S™

COWEN'S™ BAITFISH hc

COLOR	SIZE	CODE	I*
CHARTREUSE/WHITE	1/0	16030	
GRAY/WHITE	1/0	16031	
OLIVE/WHITE	1/0	19158	



COWEN'S™

COYOTE hc

COLOR	SIZE	CODE	I*
BLUE/CHARTWHITE	1	18281	
CHARTREUSE/WHITE	1	18273	



BLADO'S™

CREASE FLY hc

COLOR	SIZE	CODE	I*
BLACK BACK	1/0	16706	
	3/0	16705	
BLUE BACK	1/0	17755	
	3/0	17754	
FIRE TIGER	1/0	16704	
OLIVE BACK	1/0	17751	
	3/0	17750	
SILVER	1/0	16717	
	3/0	16716	



THALKEN'S™

CRUISER hc

COLOR	SIZE	CODE	M*
BLACK/PURPLE	3/0	70868	
CHARTREUSE/WHITE	2/0	18821	
SARDINA	2/0	18823	
SHAD	2/0	18826	



DECEIVER hc

COLOR	SIZE	CODE	D*
BLACK	2/0	15468	
CHARTREUSE/WHITE	4/0	15472	
	2/0	15471	
	1/0	15470	
	2	15469	
	RED/WHITE	2/0	15484
	1/0	15483	
	2	15482	
WHITE	4/0	15501	
	2/0	15500	
	1/0	15499	
	2	15498	
WHITE/BLUE	2/0	15508	
	1/0	15507	
	2	15506	

ALL PURPOSE SALT



STUDENT'S™

FISHALICIOUS

COLOR	SIZE	CODE	H*
CHARTREUSE/BLACK	1/0	19968	
OLIVE/BLACK/OLIVE	1/0	19970	
RED/WHITE	1/0	19971	



SKOK'S™

FLASHFIRE MUSHIES HC

COLOR	SIZE	CODE	K*
CHARTREUSE/WHITE	2/0	17625	
GRAY/WHITE	2/0	17627	
OLIVE/WHITE	2/0	17626	



BLANTON'S™

FLASHTAIL WHISTLER HC

COLOR	SIZE	CODE	H*
ORANGE/YELLOW	3/0	15104	
RED/WHITE	3/0	15114	
RED/YELLOW	3/0	15119	



GAMECHANGER HC (4.5" LENGTH)

COLOR	SIZE	CODE	L*
PEARL/WHITE	2/0	70313	
RAINBOW	2/0	70314	



CONNER'S™

GLADES MINNOW HC

COLOR	SIZE	CODE	G*
OLIVE/GRAY	2	15068	



GUMMY MINNOW HC

COLOR	SIZE	CODE	J*
BLUE	2	15752	
	6	15753	
BROWN	2	15086	
	6	15620	
CHARTREUSE	2	16170	
	6	16171	
CLEAR	6	15021	
GREEN	2	15087	
	6	15089	
PEARL	2	15088	
	6	15619	



TMC 600SP

GUMMY MINNOW BIG GAME HC

COLOR	SIZE	CODE	K*
PEARL	2	15023	



HUDSPETH'S™

HUD'S BUSHWACKER

COLOR	SIZE	CODE	H*
BLUE/WHITE	2/0	70389	
PURPLE	2/0	70390	
SHAD	2/0	70391	
WHITE	2/0	70392	
CHARTREUSE/WHITE	2/0	70393	



JERSEY TURNPIKE

COLOR	SIZE	CODE	E*
GLASS	6	71033	



KA-CUDDA HC

COLOR	SIZE	CODE	K*
FLUORESCENT GREEN	2/0	SI61136	



KINTZ'S™

MAJOR BUNKER HC

COLOR	SIZE	CODE	L*
GRAY/BROWN	4/0	15408	



KINTZ'S™

MAJOR HERRING HC

COLOR	SIZE	CODE	L*
BLACK/BLUE/GRAY	3/0	10609	



KINTZ'S™

MAJOR MULLET HC

COLOR	SIZE	CODE	L*
BROWN/TAN/GRAY	3/0	10610	



CONNER'S™

MIDNIGHT MINNOW HC

COLOR	SIZE	CODE	DD*
	6	19480	



CONNER'S™

MIDNIGHT MULLET HC

COLOR	SIZE	CODE	G*
	1/0	19500	



MURDICH'S™

MURDICH™ MINI MINNOW HC

COLOR	SIZE	CODE	H*
GRAY/WHITE	4	70888	
CHARTREUSE/WHITE	4	70889	
COPPER	4	70891	
GOLD	4	70892	
COPPER/YELLOW	4	70893	



MURDICH'S™

MURDICH™ MINNOW HC

COLOR	SIZE	CODE	H*
CHARTREUSE/WHITE	1/0	10800	
COPPER/WHITE	1/0	19497	
COPPER/YELLOW	1/0	70220	
GOLD/WHITE	1/0	19498	
GRAY/WHITE	1/0	10804	



MURDICH'S™

MURDICH MINNOW MARABOU

COLOR	SIZE	CODE	H
CHART/WHITE	1/0	73194	
GREY/WHITE	1/0	73195	
OLIVE/BLACK	1/0	73196	
BLURPLE	1/0	73197	



MAYFIELD'S™

RATTLE MULLET HC			
COLOR	SIZE	CODE	J*
CHARTREUSE/WHITE	2	10607	
OLIVE/WHITE	2	10605	



ANDERSON'S™

REDUCER			
COLOR	SIZE	CODE	K*
PEACOCK	3/0	12461	
SHAD	1/0	19163	



SEA HABIT BUCKTAIL HC			
COLOR	SIZE	CODE	H*
ANCHOVY	2	15245	
HERRING	2	15247	
SARDINE	2	15248	



VEVERKA™

SHINECOCK SILVERSIDES			
COLOR	SIZE	CODE	E*
	2	70520	
	4	70521	



SKINNY WATER CLOUSER MINNOW W6 HC			
COLOR	SIZE	CODE	F
CHARTREUSE/WHITE	4	16749	
	6	16739	
GRAY/WHITE	6	16742	
PINK/WHITE	4	16746	
TAN/WHITE	4	16743	



WHITE'S™

SLG MINNOW			
COLOR	SIZE	CODE	F*
BLK/PURPLE	01	74253	
CHARTREUSE	01	74254	
RAINBOW	01	74255	
WHITE	01	74256	
YELLOW	01	74257	



COWENS'S™

SOMETHIN ELSE			
COLOR	SIZE	CODE	K
GRAY/ WHT	02	17310	
	04	17308	
OLIVE/ WHT	02	17311	
	04	17309	



ANDERSON'S™

SPACE INVADER HC			
COLOR	SIZE	CODE	K*
BLOOD BAIT	2/0	71123	
BUTTERFLY	2/0	71124	
NIGHT RIDER	2/0	71125	



HAINES™

SUPREME HAIR SHRIMP			
COLOR	SIZE	CODE	G*
OLIVE	2	70878	
	6	70879	
TAN	2	15255	
	6	15256	
WHITE	2	70880	
	6	70881	



HAINES™

SUPREME HAIR RATTLE SHRIMP			
COLOR	SIZE	CODE	J*
OLIVE	1	70876	
WHITE	1	70877	
TAN	1	10060	



SURF CANDY HC			
COLOR	SIZE	CODE	G*
LIME GREEN	1/0	15534	
LIGHT BLUE	1/0	15535	
OLIVE	1/0	15536	



TIDE RIDER			
COLOR	SIZE	CODE	E*
BROWN	6	71140	
OLIVE	6	71141	



BOYER'S™

TODD'S WIGGLE MINNOW HC			
COLOR	SIZE	CODE	H*
BAITFISH	2/0	10067	
CHARTREUSE	2/0	10068	
RED/WHITE	2/0	10069	



MURDICH'S™

MURDICH™ WIGGLER			
COLOR	SIZE	CODE	F*
BLACK	2	18105	
ROOTBEER	2	18107	
TAN	2	18108	
WHITE	2	18109	



SKOK'S™

MUSHMOUTH HC			
COLOR	SIZE	CODE	I*
CHARTREUSE/WHITE	2/0	17620	
SAND/WHITE	2/0	17621	
BLUE/WHITE	2/0	17619	
YELLOW/WHITE	2/0	17622	



SKOK'S™

MUSHMOUTH MINI			
COLOR	SIZE	CODE	H*
CHARTREUSE/PEARL	1/0	71063	
PEACOCK/PEARL	1/0	71064	

ALL PURPOSE SALT



CHICONE'S™

TUSCAN BUNNY HC

COLOR	SIZE	CODE	H*
BLACK/PURPLE	3/0	71162	



YANKANICH'S™

YANK'S ASSASSIN HC

COLOR	SIZE	CODE	I*
REDFISH	2	17590	



ULTRA SHRIMP

COLOR	SIZE	CODE	F*
TAN	4	15611	
	1/0	15609	



UMPQUA™ CUDA FLY TANDEM HC

COLOR	SIZE	CODE	H*
FLOURESCENT GREEN	2/0	16259	



UMPQUA™ SWIMMING BAITFISH WG

COLOR	SIZE	CODE	J*
RED/WHITE	1/0	15571	
RED/YELLOW	1/0	15576	
SHAD	1/0	15565	
	4	15570	



SKOK'S™

WHITEBAIT MUSHY HC

COLOR	SIZE	CODE	F*
BAY ANCHOVY	2	16177	
CHARTREUSE/WHITE	2	16175	
SILVERSIDE	2	16176	
TUTTI FRUITI	2	16178	
WHITE	2	71172	



SALTWATER FLYS

LEADER & TIPPET

PACKS & BAGS

ACCESSORIES

HOOKS

TOOLS & KITS

TYING MATERIALS

NECKS & SADDLES



FLY SELECTIONS



PREMIUM UPG BONEFISH SELECTION

09285

FLY NAME	SIZE	QTY
RAG HEAD CRAB, TAN	6	2
CHILI PEPPER, GOLD	6	2
BONEFISH BITTERS, HERMIT CRAB MATTHEW'S™	8	2
BONEFISH BITTERS, OLIVE MATTHEW'S™	8	2
CHRISTMAS ISLAND SPECIAL, ORANGE KAUFFMANN'S™	6	2
CHRISTMAS ISLAND SPECIAL, PEARL KAUFFMANN'S™	6	2
CRAZY CHARLIE, PINK	6	2
CRAZY CHARLIE, TAN	6	2
GOTCHA, PEARL	4	2
GOTCHA, PEARL	6	2
MINI PUFF, ORANGE	6	2
MINI PUFF, PINK	6	2
SWIMMING SHRIMP	6	2
SQUIMP, TAN	6	2
BONEFISH SCAMPI (BEAD CHAIN), TAN COWEN'S™	6	2
FLATS FLY, TAN	4	2
BONEFISH DEEP MINNOW, FOXEE RED	6	2
CLOUSER DEEP MINNOW, GOLD SHINER	6	2
TOTAL FLIES		36
PRICE		\$103.39
SRP		\$187.99

*CONTENTS MAY VARY DUE TO AVAILABILITY

199

FLIES

LEADER & TIPPET

PACKS & BAGS

ACCESSORIES

HOOKS

TOOLS & KITS

TYING MATERIALS

NECKS & SADDLES



PREMIUM UPG EASTERN TROUT SELECTION

09284

FLY NAME	SIZE	QTY
SPUNDUN, SULPHUR/PMD	16	2
EVERGREEN EASTERN GREEN DRAKE OLIVERIO'S™	8	2
EVERGREEN COFFIN FLY, WHITE OLIVERIO'S™	8	2
MARCH BROWN, EASTERN A.K.'S™	14	2
PARACHUTE, SULPHUR	16	2
SPUNDUN, HENDRICKSON	14	2
SPUNDUN, MARCH BROWN	14	2
DROWNED SPINNER, TRICO BARR'S™	20	2
SPUNDUN, BAETIS	18	2
BECK'S™ SPINNER, SULPHUR	16	2
BECK'S™ EMERGER, HENDRICKSON	14	2
PEARL BUTT TRICO SPINNER	20	2
VIS-A-DUN, BAETIS BARR'S™	18	2
VIS-A-DUN, TRICO BARR'S™	20	2
PARACHUTE BWO	18	2
CRYSTAL WING SPINNER, RUSTY OLIVERIO'S™	14	2
SPOTLIGHT EMERGER, SULPHUR	16	2
SPOTLIGHT EMERGER, MARCH BROWN	14	2
BLUE WING OLIVE	18	2
HUNCHBACK (INFREQUENS) BURK'S™	16	2
POXYBACK, WESTERN GREEN DRAKE MERCER'S™	10	2
FLASHBACK EMERGER, BWO BARR'S™	18	2
EMERGER (WET), TRICO BARR'S™	22	2
TOTAL FLIES		46
PRICE		\$103.39
SRP		\$187.99

*CONTENTS MAY VARY DUE TO AVAILABILITY



PREMIUM UPG ROCKIES TROUT SELECTION

09282

FLY NAME	SIZE	QTY
E-Z CADDIS, TAN LAWSON'S™	16	2
TURCK'S™ TARANTULA, BROWN	8	2
STIMULATOR, YELLOW KAUFMANN'S™	14	2
STIMULATOR, ROYAL KAUFMANN'S™	14	2
PARACHUTE, ADAMS	14	2
PARACHUTE, ADAMS	16	2
PARACHUTE, LIGHT ORANGE	16	2
ROYAL WULFF	14	2
FLASHBACK CADDIS NYMPH	16	2
GOLD BEAD HARE'S EAR	16	2
MADAM X	10	2
COPPER JOHN, GOLD BEAD COPPER BARR'S™	14	2
COPPER JOHN, GOLD BEAD COPPER BARR'S™	16	2
GOLD BEAD RUBBER LEG STONE, BLACK KAUFMANN'S™	8	2
PRINCE NYMPH, GOLD BEAD	12	2
PRINCE NYMPH, GOLD BEAD	14	2
POXYBACK, PMD MERCER'S™	16	2
PHEASANT TAIL NYMPH, GOLD BEAD	16	2
PHEASANT TAIL NYMPH, GOLD BEAD	18	2
MICRO STONE NYMPH, COPPER BEAD MERCER'S™	14	2
GB EPOXY STONE GOLD MERCER'S™	12	2
X CADDIS, TAN MATTHEW'S™	16	2
THORAX, PMD LAWSON'S™	16	2
PARACHUTE HOPPER, TAN SCHROEDER'S™	10	2
DAVE'S HOPPER	10	2
CRIPPLE DUN, PMD LAWSON'S™	16	2
TOTAL FLIES		50
PRICE		\$106.14
SRP		\$192.99

*CONTENTS MAY VARY DUE TO AVAILABILITY

FLY SELECTIONS



PREMIUM TENKARA SELECTION

09288

FLY NAME	SIZE	QTY
IMPROVED SPARKLE DUN, BAETIS MATHEW'S™	18	1
MICRO BEELEY MATHEW'S™	16	1
S.T. MIDGE, BLACK MATHEW'S™	18	1
TENKARA PRINCE, COPPER	16	2
TENKARA BLOODY STONE MATHEW'S™	14	1
TENKARA X CADDIS, TAN MATHEW'S™	16	1
TENKARA CADDIS PUPA, GREEN	16	1
TENKARA GLASS EMERGER	17	1
TENKARA MIDGE, DARK MATHEW'S™	20	1
TENKARA PHEASANT TAIL NYMPH	15	2
TENKARA SPARKLE DUN, PMD MATHEW'S™	16	1
TENKARA WULF, ROYAL	17	2
TENKARA BWO EMERGER MATHEW'S™	20	1
TENKARANT, BLACK	13	2
WIRED T DIP, PURPLE MATHEW'S™	16	1
WIRED T DIP, RUST	14	1
TOTAL FLIES		20
PRICE		\$42.89
SRP		\$77.99

*CONTENTS MAY VARY DUE TO AVAILABILITY



PREMIUM UPG CALIFORNIA TROUT SELECTION

09283

FLY NAME	SIZE	QTY
ROGUE FOAM STONE, GOLDEN SCHLOTTER'S™	8	2
SPOTLIGHT CADDIS EMERGER, OLIVE	16	2
E/C CADDIS, OLIVE CUTTER'S™	16	2
E/C CADDIS, OLIVE CUTTER'S™	18	2
LITTLE YELLOW STONEFLY CUTTER'S™	14	2
STIMULATOR, YELLOW KAUFMANN'S™	14	2
STIMULATOR, YELLOW KAUFMANN'S™	16	2
PARACHUTE, ADAMS	14	2
PARACHUTE, ADAMS	16	2
PARACHUTE, ADAMS	16	2
PARACHUTE ANT, BLACK SCHROEDER'S™	16	2
DARK LORD, BLACK/GOLD BEAD HART'S™	14	2
POXYBACK EMERGER, CALLIBEAETIS MERCER'S™	16	2
BIRD'S NEST, HARE'S EAR/GOLD BEAD BIRD'S™	14	2
CRYSTAL HUNCHBACK PMD BURK'S™	16	2
CADDIS POOPAH, TAN/COPPER BEAD	16	2
CADDIS POOPAH OLIVE/GOLD BEAD	16	2
COPPER JOHN, COPPER/GOLD BEAD BARR'S™	14	2
COPPER JOHN, RED/GOLD BEAD BARR'S™	16	2
AGGRAVATOR NYMPH, PRINCE/GOLD BEAD BURK'S™	12	2
PRINCE NYMPH, GOLD BEAD	14	2
PHEASANT TAIL NYMPH, GOLD BEAD	16	2
PHEASANT TAIL NYMPH, GOLD BEAD	18	2
MICRO MAYFLY NYMPH, COPPER BEAD MERCER'S™	16	2
MICRO STONE NYMPH, COPPER BEAD MERCER'S™	16	2
BIOT EPOXY STONE NYMPH, GOLDEN/GB MERCER'S™	10	2
PARACHUTE HOPPER, TAN SCHROEDER'S™	10	2
CRIPPLE DUN, PMD LAWSON'S™	20	2
TOTAL FLIES		54
PRICE		\$103.39
SRP		\$187.99

*CONTENTS MAY VARY DUE TO AVAILABILITY



PREMIUM UPG ULTIMATE TROUT SELECTION

09286

FLY NAME	SIZE	QTY
STIMULATOR (BARBLESS), YELLOW KAUFMANN'S™	12	2
STIMULATOR (BARBLESS), ROYAL KAUFMANN'S™	14	2
STIMULATOR (BARBLESS), ORANGE KAUFMANN'S™	14	2
STIMULATOR (BARBLESS), OLIVE KAUFMANN'S™	16	2
X CADDIS, TAN MATHEW'S™	16	2
PARACHUTE, ADAMS	16	2
PARACHUTE, ADAMS	18	2
ROYAL WULFF	14	2
ROYAL WULFF	16	2
E/C CADDIS, OLIVE CUTTER'S™	16	2
SPARKLE DUN, SULPHUR MATHEW'S™	16	2
SPARKLE DUN, BAETIS OLIVE MATHEW'S™	18	2
E-Z CADDIS, OLIVE LAWSON'S™	16	2
PARACHUTE, BWO	18	2
BLACK BEETLE	14	2
DAVE'S HOPPER	10	2
PARACHUTE HOPPER, TAN SCHROEDER'S™	10	2
MADAM X	10	2
TURCK'S™ TARANTULA, BROWN	8	2
WOOLY BUGGER, OLIVE	8	2
GOLD BEAD CRYSTAL BUGGER, BLACK	8	2
PRINCE NYMPH, GOLD BEAD	12	2
PRINCE NYMPH, GOLD BEAD	14	2
GB PHEASANT TAIL	16	2
GB PHEASANT TAIL	18	2
GOLD BEAD HARE'S EAR	16	2
GOLD BEAD RUBBER LEG STONE, BLACK KAUFMANN'S™	10	2
KAUFMANN'S GB RUBBER LEG STONE, BLACK	8	2
COPPER JOHN, RED BARR'S™	16	2
COPPER JOHN, RED BARR'S™	18	2
MICRO MAYFLY NYMPH, OLIVE MERCER'S™	16	2
BIOT EPOXY STONE NYMPH, GOLDEN/GB MERCER'S™	12	2
FLASHBACK HARE'S EAR	16	2
SQUIRREL NYMPH, GOLD BEAD	14	2
POXYBACK, PMD MERCER'S™	16	2
DEEP SPARKLE PUPA, BROWN/YELLOW LAFONTAINE'S™	14	2
POXYBACK, BAETIS MERCER'S™	18	2
Z-WING CADDIS, AMBER MERCER'S™	14	2
TOTAL FLIES		78
PRICE		\$156.74
SRP		\$284.99

*CONTENTS MAY VARY DUE TO AVAILABILITY

FLIES

LEADER & TIPPET

PACKS & BAGS

ACCESSORIES

HOOKS

TOOLS & KITS

TYING MATERIALS

NECKS & SADDLES



ALASKA SELECTIONS

FLY NAME	SIZE	09269 09255	
		DELUXE	GUIDE
EGG, OREGON CHEESE	8	1	3
EGG, FLORESCENT, ORANGE	8	1	3
EGG, PINK CHAMPAGNE	10	1	3
FLESH FLY	4	1	3
EGG SUCKING CRYSTAL LEECH, BLACK	2	1	2
EGG SUCKING CRYSTAL LEECH, PURPLE	2	1	2
STARLITE LEECH, PINK	2	1	2
STARLITE LEECH, PURPLE	2	1	2
ALASKA FLASH FLY, SILVER/RED	2	1	2
ALASKA FLASH FLY, PURPLE	2	1	2
MOUSERAT	6	1	2
ALASKABOU, POPSICLE	1/0	1	3
ALASKABOU, MANHATTAN BEACH	1/0	1	2
ALASKABOU, SHOWGIRL	1/0	1	3
GB CRYSTAL BUGGER, BLACK	6	1	2
GB CRYSTAL BUGGER, OLIVE	6	1	2
CLOUSER MINNOW OLIVE/WHITE	2		2
WOOL-HEAD SCULPIN, OLIVE	4		2
TOTAL FLIES		16	42
PRICE		\$41.24	\$90.74
SRP		\$74.99	\$164.99

*CONTENTS MAY VARY DUE TO AVAILABILITY



BAHAMAS SELECTIONS

FLY NAME	SIZE	09270 09256	
		DELUXE	GUIDE
PERMIT CRAB	2		2
MANTIS SHRIMP, TAN	4	1	2
BORSKI'S BONEFISH SLIDER	6	1	2
BONEFISH CLOUSER MINNOW	4		2
CLOUSER MINNOW, GOLDEN	6	1	2
SQUIMP, TAN	6	1	2
RAG HEAD CRAB, TAN	6	1	2
CLOUSER MINNOW, CHARTREUSE/WHITE	6	1	2
GOTCHA, PEARL	2	1	2
GOTCHA, PEARL	4	1	2
BONEFISH SCAMPI, TAN	6	1	2
FLATS FLY, TAN	4		2
MINI PUFF, ORANGE	4	1	2
CRAZY CHARLIE, TAN	6	1	2
CRAZY CHARLIE, PINK	6	1	2
BONEFISH DEEP MINNOW, FOXEE RED	4	1	
TOTAL FLIES		13	30
PRICE		\$34.64	\$78.64
SRP		\$62.99	\$142.99

*CONTENTS MAY VARY DUE TO AVAILABILITY



BELIZE/YUCATAN SELECTIONS

FLY NAME	SIZE	09271 09257	
		DELUXE	GUIDE
CHRISTMAS ISLAND SPECIAL, ORANGE	8	1	3
CHRISTMAS ISLAND SPECIAL, PEARL	8	1	3
SQUIMP, TAN	8	1	2
CRAZY CHARLIE, TAN	6	1	2
BONEFISH SCAMPI, BEAD CHAIN TAN	6	1	3
PERMIT CRAB	2	1	1
FLATS CRAB, LIGHT OLIVE	4		1
FLATS CRAB, TAN	4		1
CLOUSER MINNOW, CHARTREUSE/WHITE	6		2
BONEFISH BITTERS, OLIVE	8	1	2
BONEFISH BITTERS, HERMIT CRAB	8	1	2
MINI KRYPSTAL SHRIMP PINK/PEARL	6	1	2
TURNEFFE CRAB, CREAM	6	1	1
TURNEFFE CRAB, OLIVE	6	1	1
BONEFISH DEEP MINNOW, FOXEE RED	6	1	2
GOTCHA, PEARL	6	1	2
GOTCHA, PEARL	8	1	2
MINI PUFF, ORANGE	6	1	2
TOTAL FLIES		15	34
PRICE		\$37.39	\$78.64
SRP		\$67.99	\$142.99

*CONTENTS MAY VARY DUE TO AVAILABILITY

DELUXE SPECIES DESTINATION FLY SELECTIONS

The perfect retail "entry level" selection. All Deluxe selections are packaged in attractive clam-pack containers with an Umpqua header card so that they can be displayed both on a counter and on slat wall.

DESTINATION FLY SELECTIONS

These selections were specifically called "Guide Selections" so that when your destination travel customers arrive at their exotic fishing location, it will be virtually impossible for the guides to mutter their favorite phrase, "those flies don't work here". Packaged in attractive clam-pack containers with an Umpqua header card so that they can be displayed both on a counter and on slat wall.

FLY SELECTIONS



BONEFISH SELECTIONS

FLY NAME	SIZE	09272 09258	
		DELUXE	GUIDE
RAG HEAD CRAB, TAN	6	1	2
CHILI PEPPER, GOLD	6	1	2
BONEFISH BITTERS, HERMIT CRAB	8	1	2
BONEFISH BITTERS, OLIVE	8	1	2
CHRISTMAS ISLAND SPECIAL, ORANGE	6	1	2
CHRISTMAS ISLAND SPECIAL, PEARL	6	1	2
CRAZY CHARLIE, PINK	6	1	2
CRAZY CHARLIE, TAN	6	1	2
GOTCHA, PEARL	4	2	2
GOTCHA, PEARL	6	2	2
MINI PUFF, ORANGE	6	1	2
MINI PUFF, PINK	6	1	2
SWIMMING SHRIMP	6		2
SQUIMP, TAN	6	1	2
BONEFISH SCAMPI, BEAD CHAIN TAN	6	1	2
FLATS FLY, TAN	4		2
BONEFISH CLOUSER, FOXEE RED	6	1	2
CLOUSER MINNOW, GOLD SHINER	6		2
TOTAL FLIES		17	36
PRICE		\$46.19	\$90.74
SRP		\$83.99	\$164.99

*CONTENTS MAY VARY DUE TO AVAILABILITY

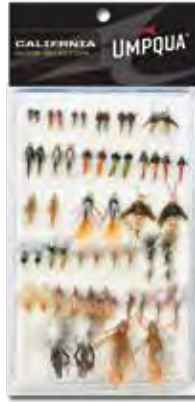

CALIFORNIA SELECTIONS

FLY NAME	SIZE	09273 09259	
		DELUXE	GUIDE
ROGUE FOAM STONE, GOLDEN	8		2
SPOTLIGHT CADDIS EMERGER, OLIVE	16	1	2
E/C CADDIS, OLIVE	16	1	2
E/C CADDIS, OLIVE	18	1	2
LITTLE YELLOW STONEFLY	14	1	2
KAUFMANN'S STIMULATOR, YELLOW	14		2
KAUFMANN'S STIMULATOR, YELLOW	16		2
PARACHUTE, ADAMS	14	1	2
PARACHUTE, ADAMS	16	1	2
PARACHUTE ANT, BLACK	16	1	2
DARK LORD, BLACK/GB	14	1	2
POXYBACK EMERGER, CALLI-BEAETIS	16		2
BIRD'S NEST, HARE'S EAR/GB	14	1	2
CRYSTAL HUNCHBACK, PMD	16	1	2
BDHD CADDIS POOPAH, TAN	16	1	2
BDHD CADDIS POOPAH, OLIVE	16	1	2
COPPER JOHN, COPPER/GB	14	1	2
COPPER JOHN, RED/GB	16	1	2
AGGRAVATOR, PRINCE/GB	12	1	2
PRINCE NYMPH, GB	14	1	2
PHEASANT TAIL, GB	16		2
PHEASANT TAIL, GB	18		2
MICRO MAYFLY, CB	16	1	2
MICRO STONE, CB	16	1	2
BIOT EPOXY STONE NYMPH, GOLDEN/GB	10	1	2
PARACHUTE HOPPER, TAN	10		2
MIDGELING, OLIVE	18	1	2
TOTAL FLIES		20	54
PRICE		\$37.39	\$85.24
SRP		\$67.99	\$154.99

*CONTENTS MAY VARY DUE TO AVAILABILITY



EASTERN TROUT SELECTIONS

FLY NAME	SIZE	09274 09260	
		DELUXE	GUIDE
SPUNDUN, SULPHUR/PMD	16	1	2
EVERGREEN EASTERN GREEN DRAKE	8	1	2
EVERGREEN COFFIN FLY, WHITE	8	1	2
MARCH BROWN, EASTERN	14		2
PARACHUTE, SULPHUR	16	1	2
SPUNDUN, HENDRICKSON	14	1	2
SPUNDUN, MARCH BROWN	14		2
DROWNED SPINNER, TRICO	20	1	2
SPUNDUN, BAETIS	18	1	2
BECK'S SPINNER, SULPHUR	16	1	2
BECK'S EMERGER, HENDRICKSON	14	1	2
PEARL-BUTT TRICO SPINNER	20	1	2
VIS-A-DUN, BAETIS	18	1	2
VIS-A-DUN, TRICO	20	1	2
PARACHUTE, BWO	18	1	2
CRYSTAL WING SPINNER, RUSTY	14		2
AK'S RED QUILL SPINNER	14	1	
SPOTLIGHT EMERGER, SULPHUR	16	1	2
SPOTLIGHT EMERGER, MARCH BROWN	14		2
SPOTLIGHT EMERGER, EASTERN DARK HENDRICKSON	14	1	
BLUE WING OLIVE	18	1	2
HUNCHBACK (INFREQUENS)	16	1	2
POXYBACK, GREEN DRAKE	10		2
FLASHBACK EMERGER, BWO	18	1	2
BARR'S EMERGER, TRICO	22	1	2
TOTAL FLIES		20	46
PRICE		\$41.24	\$78.64
SRP		\$74.99	\$142.99

*CONTENTS MAY VARY DUE TO AVAILABILITY

FLIES

LEADER & TIPPET

PACKS & BAGS

ACCESSORIES

HOOKS

TOOLS & KITS

TYING MATERIALS

NECKS & SADDLES



GREAT LAKE SELECTIONS

09275 09261

FLY NAME	SIZE	DELUXE	GUIDE
EGG, PINK CHAMPAGNE	8	1	2
EGG, PEACH	8	1	2
EGG, FLUORESCENT ORANGE	8	1	3
EGG, OREGON CHEESE	8	1	3
EGG, CHARTREUSE	8	1	3
BEAR'S CRYSTAL EGG, PEACH	8	1	2
BEAR'S CRYSTAL EGG, ORANGE	8	1	2
BEAR'S CRYSTAL EGG, CHARTREUSE	8	1	2
PCP NYMPH	8	1	2
BEAR'S STONE	10	1	2
CADDIS LARVA, CHARTREUSE	8	1	2
BEAR'S PM CADDIS	8	1	2
ANTRON BUG HEX	6	1	2
BEAR'S FUZZ BUSTER OLIVE	8	1	2
ANTRON BUG SHRIMP	6	1	2
STEELHEAD BUGGER	6	1	2
EGG SUCKING LEECH, ORANGE	4	1	2
HEX NYMPH	6	1	2
BEAR'S PHEASANT TAIL	8		2
BEAR'S FUZZ BUSTER, BLACK	8		2
PM STONE	6	1	2
BEAR'S HEX	6	1	2
TOTAL FLIES		20	47
PRICE		\$41.24	\$85.24
SRP		\$74.99	\$154.99

*CONTENTS MAY VARY DUE TO AVAILABILITY



LARGEMOUTH BASS SELECTIONS

09276 09262

FLY NAME	SIZE	DELUXE	GUIDE
HOT FLASH MINNOW SHINER	2	1	1
BOUFACE, RED/WHITE	2	1	1
ZONKER, WHITE/PEARL	4		1
SHINABOU SHINER, WOOLHEAD	4		1
SWIMMING SHAD	2	1	1
SCORPION, ROOT BEER	4		1
KAUFMANN'S GB RUBBERLEG WOOLY BUGGER, BLACK	4	1	1
DAHLBERG'S RABBIT STRIP DIVER, CHARTREUSE	4		1
POPPER (WITH LEGS), BLACK	6	1	1
POPPER (WITHOUT LEGS), FROG	6	1	1
FRUIT COCKTAIL	10	1	1
DEER HAIR BUG PORKEY'S PET	6	1	1
WIGGLELEGS FROG	6		1
UMPQUA SWIMMING FROG, WHITE BELLY	6		1
DIVING BUG, FROG	6	1	1
TOTAL FLIES		9	15
PRICE		\$46.74	\$68.74
SRP		\$84.99	\$124.99

*CONTENTS MAY VARY DUE TO AVAILABILITY



NORTHERN ROCKIES TROUT SELECTIONS

09277 09263

FLY NAME	SIZE	DELUXE	GUIDE
LAWSON'S E-Z CADDIS, OLIVE	16	1	2
TURK'S TARANTULA, BROWN	8	1	2
KAUFMANN'S STIMULATOR, YELLOW	14	1	2
KAUFMANN'S STIMULATOR, ROYAL	14		2
PARACHUTE, ADAMS	14		2
PARACHUTE, ADAMS	16	1	2
PARACHUTE, LIGHT ORANGE	16	1	2
ROYAL WULF	14	1	2
FLASHBACK CADDIS, HARE'S EAR/GB	16	1	2
MADAM X	10	1	2
BARR'S COPPER JOHN, COPPER/GB	14	1	2
BARR'S COPPER JOHN, COPPER/GB	16	1	2
KAUFMANN'S MINI STONE, BLACK/GB	8		2
PRINCE NYMPH, GB	12		2
PRINCE NYMPH, GB	14	1	2
MERCER'S POXYBACK PMD	16	1	2
PHEASANT TAIL, GB	16	1	2
PHEASANT TAIL, GB	18		2
MERCER'S MICRO STONE/CB	14	1	2
BIOT EPOXY STONE NYMPH, GOLDEN/GB	12	1	2
X CADDIS, TAN	16	1	2
LAWSON'S THORAX, PMD	16	1	2
PARACHUTE HOPPER, TAN	10	1	2
DAVE'S HOPPER	10	1	2
LAWSON'S CRIPPLE DUN, PMD	16	1	2
TOTAL FLIES		20	50
PRICE		\$41.24	\$97.34
SRP		\$74.99	\$176.99

*CONTENTS MAY VARY DUE TO AVAILABILITY

FLY SELECTIONS



SOUTHERN ROCKIES TROUT SELECTIONS

09279 09265

FLY NAME	SIZE	DELUXE	GUIDE
ELK CADDIS, OLIVE	16	1	2
PEACOCK CADDIS	16	1	2
E/C CADDIS, OLIVE	16	1	2
RS2 EMERGER, DUN	20	1	2
COLORADO GREEN DRAKE	12	1	2
HUMPY, YELLOW	16	1	2
KAUFMANN'S STIMULATOR, YELLOW	14		2
KAUFMANN'S STIMULATOR, ROYAL	14	1	2
PARACHUTE, ADAMS	16		2
PARACHUTE, ADAMS	18	1	2
PARACHUTE, BWO	18	1	2
ROYAL WULFF	16	1	2
FLASHBACK CADDIS, HARE'S EAR/GB	14		2
A.K.'S PMD QUILL, YELLOW	18	1	2
BUCKSKIN CADDIS	16	1	2
BARR'S COPPER JOHN, COPPER/GB	16		2
BARR'S COPPER JOHN, RED/GB	16	1	2
PRINCE NYMPH, GB	14		2
PRINCE NYMPH, GB	16	1	2
POXYBACK, WESTERN GREEN DRAKE	12	1	2
MERCER'S POXYBACK PMD,	16		2
PHEASANT TAIL, GB	16		2
PHEASANT TAIL, GB	18	1	2
MICRO MAYFLY, OLIVE/CB	18	1	2
BIOT EPOXY STONE NYMPH, GOLDEN/GB	12		2
GRIFFITH'S GNAT	20	1	2
PARACHUTE HOPPER, TAN	12		2
BARR'S BEAD HEAD EMERGER, BWO	20	1	2
TOTAL FLIES		19	56
PRICE		\$37.39	\$93.49
SRP		\$67.99	\$169.99

*CONTENTS MAY VARY DUE TO AVAILABILITY



REDFISH/SEATROUT SELECTIONS

09264

FLY NAME	SIZE	GUIDE
CAVE'S WOBBLER, GOLD	2	1
DINK, CHARTREUSE	6	1
SEA DUCER, WHITE/RED	4	1
SEA DUCER, CHARTREUSE/GRIZZLY	4	1
RATTLE MULLET, OLIVE/WHITE	2	1
UMPQUA SWIMMING BAITFISH, SHAD	1/0	1
SKINNY WATER CLOUSER MINNOW, TAN/WHITE	2	2
SKINNY WATER CLOUSER MINNOW, CHARTREUSE/WHITE	2	2
CLOUSER MINNOW, SCULPIN	6	1
CONNOR'S GLADES MINNOW, OLIVE/GRAY	2	1
HOT FLASH MINNOW, SHINER	2	1
DORSY'S KWAN, BEAD CHAIN TAN	4	1
DORSY'S KWAN, BEAD CHAIN CHARTREUSE	4	1
BORSKI'S BONEFISH SLIDER, BROWN	4	1
BORSKI'S BONEFISH SLIDER, CHARTREUSE	4	1
BORSKI'S SUPER SWIMMING SHRIMP	2	1
BORSKI'S CHERNOBYL CRAB	2	1
TOTAL FLIES		19
PRICE		\$68.74
SRP		\$124.99

*CONTENTS MAY VARY DUE TO AVAILABILITY



FLIES

LEADER & TIPPET

PACKS & BAGS

ACCESSORIES

HOOKS

TOOLS & KITS

TYING MATERIALS

NECKS & SADDLES

FLY SELECTIONS



STRIPED BASS SELECTIONS

FLY NAME	SIZE	09280 09266	
		DELUXE	GUIDE
CLOUSER MINNOW, CHARTREUSE/WHITE	2/0	1	1
CLOUSER MINNOW, CHARTREUSE/WHITE	2		1
CLOUSER MINNOW, SILVER SHINER	2/0		1
CLOUSER MINNOW, SILVER SHINER	2	1	1
CLOUSER MINNOW, BLACK	2/0		1
HALF AND HALF, CHARTREUSE/WHITE	1/0	1	1
HALF AND HALF, GRAY/WHITE	1/0		1
DECEIVER, CHARTREUSE/WHITE	1/0	1	1
ROGER'S BIG EYE BAITFISH, CHARTREUSE	2/0	1	1
ROGER'S BIG EYE BAITFISH, HERRING	2/0		1
MURPHY'S CONDOMO SPECIAL, BLUE/BLACK	2/0		1
ROGER'S SAND EEL, GREEN/PEARL	1	1	1
BLANTON'S FLASHTAIL WHISTLER, RED/WHITE	2/0	1	1
BLANTON'S FLASHTAIL WHISTLER, WHITE/GRIZZLY	2/0		1
ROGER'S BIG EYE BAITFISH, SILVERSIDES	1/0		1
BANGER, SILVER	4/0	1	1
COWEN'S ALBIE ANCHOVY	4		1
SURF CANDY, OLIVE	1/0		1
DEEP CANDY, WHITE/PEARL	8		1
ROGER'S SLIM JIM, OLIVE/WHITE	2		1
TOTAL FLIES		8	20
PRICE		\$43.99	\$81.39
SRP		\$79.99	\$147.99

*CONTENTS MAY VARY DUE TO AVAILABILITY



TENKARA DELUXE SELECTIONS

FLY NAME	SIZE	09287	
		DELUXE	GUIDE
TENKARA BWO EMERGER	20	1	
S.T. TENKARA MIDGE, BLACK	18	1	
TENKARA X CADDIS, TAN	16	1	
WIRED T DIP, RUST	14	1	
WIRED T DIP, PURPLE	16	1	
TENKARANT, BLACK	13	1	
TENKARA CADDIS PUPA, GREEN	16	1	
TENKARA PHEASANT TAIL NYMPH	15	1	
TENKARA GLASS EMERGER	17	1	
TENKARA PRINCE, COPPER	16	1	
TENKARA WULF, ROYAL	17	2	
TOTAL FLIES			12
PRICE			\$29.14
SRP			\$52.99

*CONTENTS MAY VARY DUE TO AVAILABILITY

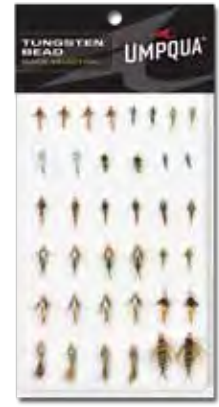

TUNGSTEN BEAD TROUT SELECTIONS

FLY NAME	SIZE	09281 09267	
		DELUXE	GUIDE
TUNGSTEN ZEBRA MIDGE, BLACK	18		2
TUNGSTEN COPPER JOHN, COPPER (2488H)	16		2
TUNGSTEN COPPER JOHN, RED (2488H)	16	1	2
TUNGSTEN RAINBOW WARRIOR	16	1	2
TUNGSTEN HOTWIRE PRINCE, RED/YELLOW	14		2
TUNGSTEN HOTWIRE PRINCE, GREEN/YELLOW	14	1	2
TUNGSTEN FLASHBACK HARES EAR	14	1	2
TUNGSTEN Z-WING CADDIS, OLIVE	16	1	2
TUNGSTEN MICRO STONE	14	1	2
TUNGSTEN WD 50, OLIVE	18	1	2
TUNGSTEN WD 50, GRAY	18	1	2
TUNGSTEN MICRO MAYFLY, OLIVE	16	1	2
TUNGSTEN 20 INCHER	12	1	2
TUNGSTEN FLASHBACK PHEASANT TAIL	18	1	2
TUNGSTEN GOLD RIBBED HARES EAR	14	1	2
TUNGSTEN PHEASANT TAIL	16	1	2
TUNGSTEN PHEASANT TAIL	18	1	2
TUNGSTEN PRINCE NYMPH	14	1	2
TUNGSTEN PRINCE NYMPH	16	1	2
TOTAL FLIES		16	38
PRICE		\$37.39	\$78.64
SRP		\$67.99	\$142.99

*CONTENTS MAY VARY DUE TO AVAILABILITY



ULTIMATE TROUT GUIDE SELECTIONS

09268

FLY NAME	SIZE	DELUXE
KAUFMANN'S STIMULATOR, YELLOW	12	2
KAUFMANN'S STIMULATOR, ROYAL	14	2
KAUFMANN'S STIMULATOR, ORANGE	14	2
KAUFMANN'S STIMULATOR, OLIVE	16	2
MATHEW'S X CADDIS TAN	16	2
PARACHUTE, ADAMS	16	2
PARACHUTE, ADAMS	18	2
ROYAL WULFF	14	2
ROYAL WULFF	16	2
E/C CADDIS, OLIVE	16	2
MATHEW'S SPARKLE DUN, SULPHUR	16	2
MATHEW'S SPARKLE DUN, BAETIS OLIVE	18	2
LAWSON'S E-Z CADDIS, OLIVE	16	2
PARACHUTE, BWO	18	2
BLACK BEETLE	14	2
DAVE'S HOPPER	10	2
PARACHUTE HOPPER, TAN	10	2
MADAM X	10	2
TURCK'S TARANTULA, BROWN	8	2
WOOLY BUGGER, OLIVE	8	2
GOLD BEAD CRYSTAL BUGGER, BLACK	8	2
PRINCE NYMPH, GB	14	2
PRINCE NYMPH, GB	12	2
PHEASANT TAIL, GB	16	2
PHEASANT TAIL, GB	18	2
HARE'S EAR, GB	16	2
KAUFMANN'S GB MINI STONE, BROWN	10	2
KAUFMANN'S GB RUBBER LEG STONE, BLACK	8	2
BARR'S COPPER JOHN, COPPER	16	2
BARR'S COPPER JOHN, COPPER	18	2
BARR'S COPPER JOHN, RED	16	2
MERCER'S MICRO MAYFLY, OLIVE	16	2
MERCER'S BIOT EPOXY STONE, GOLD	12	2
FLASHBACK HARE'S EAR	16	2
SQUIRREL NYMPH, GB	14	2
MERCER'S POXYBACK, PMD	16	2
LAFONTAINE'S DEEP SPARKLE PUPA, BROWN/YELLOW	14	2
MERCER'S POXYBACK, BAETIS	18	2
MERCER'S Z-WING CADDIS, AMBER	14	2
TOTAL FLIES	78	
PRICE	\$131.99	
SRP	\$239.99	

*CONTENTS MAY VARY DUE TO AVAILABILITY

PACKAGED FLY SELECTIONS

ITEM	QUANTITY	CODE	COST	SRP
SMALLMOUTH BASS	10	09010	\$39.59	\$71.99
FLATS	12	09016	\$39.59	\$71.99

Flies for all seasons, flies for all reasons. Carefully chosen with value in mind. For holidays or any day, these are perfect impulse selections designed to offer you easy sales.



LEADER AND TIPPET

FIVE INNOVATIVE MATERIALS

Each material has been fine tuned to match the specific needs of anglers who venture out onto the water.

Regardless if you are delivering a seemingly impossible shot to a permit or rigging up your first dry dropper rig on your local creek, we have put the angler first. Our job is to provide confidence in your angling.

PRO BANDS

Our partnership with ProBands, which come on each spool of tippet, ensure that heat does not build up and degrade the material. The snug fit of our bands keeps tippet right where you left it and not dangling down in your way. These are the best bands on the market and were developed on the water by working guides.

GUIDE TRUSTED

Our network of tyers, guides, and family have been putting these materials through the paces. Tarpon in the keys, steelhead on the OP, dry fly eaters on the Henry's Fork, and pressured wintertime fish on the South Platte have all been brought to hand with these materials. The proof is in the pudding and your adventure awaits.

THE BEST PRESENTATION FOR YOUR FLY

*UMPQUA IS PROUD TO BE THE PREFERRED
LEADER & TIPPET OF FLY FISHING TEAM USA*



UMPQUA[®]

www.umpqua.com

PERFORM X
NYLON



POWER TAPER // TROUT LEADER

FLY SIZE: 10-16

7LB // 3.2KG

4X 9FT
2.7m

UMPQUA[®]
www.umpqua.com

5X FLY SIZE:
#14-20



5.5LB
2.5KG

30YD
27.0 M
0.006"/0.15 mm

PERFORM X
NYLON
Made in Japan

PERFORM X TROUT NYLON

HOLY GRAIL COMBINATION OF STRENGTH & SUPPLENESS

Perform X delivers the Holy Grail in tippet performance – brute strength and suppleness. The right suppleness allows a perfectly dead-drifted fly to entice the most wary trout, while a secret blend of nylon results in the strength to bring the fish to net. Exceptional knot strength and abrasion resistance round out this perfectly balanced material.

PERFORM X CONSTRUCTION

Core | Co-Polymer Nylon

Perfect balance of strength and suppleness

Coating 1 | Hydrophobic Coat

water barrier – nylon should not be a sponge

Coating 2 | Continuous Coat

produces a smooth consistent, reliable material

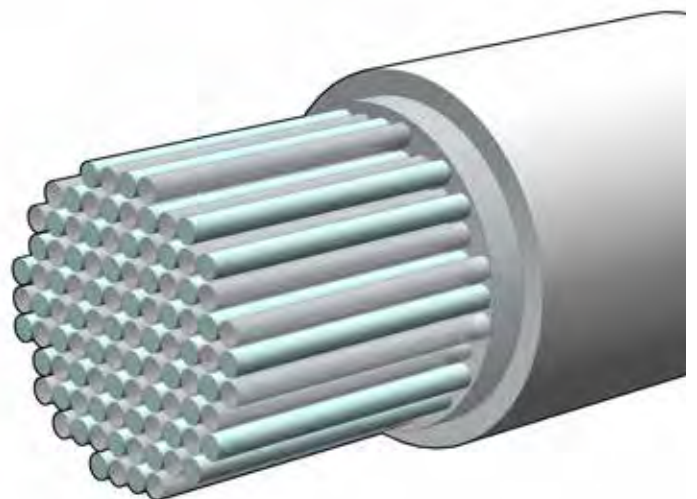

PERFORM X TROUT NYLON



**PERFORM X
NYLON TIPPET**

\$3.84 EACH
(10-30YD)
\$9.89 EACH
(100YD)

YARDS	SIZE	TEST	CODE	COST	SRP	
10	010X	40 LB	59001	\$3.84	\$6.99	
	08X	35 LB	59002	\$3.84	\$6.99	
	06X	30 LB	59003	\$3.84	\$6.99	
15	05X	25 LB	59004	\$3.84	\$6.99	
	04X	20 LB	59005	\$3.84	\$6.99	
30	02X	18 LB	59006	\$3.84	\$6.99	
	0X	16 LB	59007	\$3.84	\$6.99	
	1X	14 LB	59008	\$3.84	\$6.99	
	2X	11 LB	59009	\$3.84	\$6.99	
	3X	9 LB	59010	\$3.84	\$6.99	
	4X	7 LB	59011	\$3.84	\$6.99	
	5X	5.5 LB	59012	\$3.84	\$6.99	
	6X	3.5 LB	59013	\$3.84	\$6.99	
	7X	2.8 LB	59014	\$3.84	\$6.99	
	8X	1.7 LB	59015	\$3.84	\$6.99	
	GUIDE SPOOL					
	100	1X	14 LB	59020	\$9.89	\$17.99
		2X	11 LB	59021	\$9.89	\$17.99
		3X	9 LB	59022	\$9.89	\$17.99
		4X	7 LB	59023	\$9.89	\$17.99
	5X	5.5 LB	59024	\$8.25	\$17.99	
	6X	3.5 LB	59025	\$9.89	\$17.99	



**PERFORM X
TROUT LEADER
3-PACK**

\$9.34 EACH

LENGTH	SIZE	TEST	CODE	SRP
7.5'	3X	9 LB	59060	\$16.99
	4X	7 LB	59061	\$16.99
	5X	5.5 LB	59062	\$16.99
9'	6X	3.5 LB	59063	\$16.99
	2X	11 LB	59065	\$16.99
	3X	9 LB	59066	\$16.99
10'	4X	7 LB	59067	\$16.99
	5X	5.5 LB	59068	\$16.99
	6X	3.5 LB	59069	\$16.99
	7X	2.8 LB	59070	\$16.99
	3X	9 LB	59071	\$16.99
	4X	7 LB	59072	\$16.99
	5X	5.5 LB	59073	\$16.99
	6X	3.5 LB	59074	\$16.99

3 - Pack / This is your go-to leader for most situations. Umpqua Trout Leaders, in all three lengths, feature exclusive taper designs to ensure a perfect blend of power (heavy butt & strong taper) and delicacy (perfect tippet length).



**PERFORM X
POWER TAPER
TROUT LEADER
3-PACK**

\$9.34 EACH

LENGTH	SIZE	TEST	CODE	SRP
7.5'	2X	11 LB	59090	\$16.99
	3X	9 LB	59091	\$16.99
	4X	7 LB	59092	\$16.99
9'	5X	5.5 LB	59093	\$16.99
	6X	3.5 LB	59094	\$16.99
	2X	11 LB	59095	\$16.99
10'	3X	9 LB	59096	\$16.99
	4X	7 LB	59097	\$16.99
	5X	5.5 LB	59098	\$16.99
	6X	3.5 LB	59099	\$16.99

3 - Pack / The strongest and fastest taper available. A quick transition from heavy, long butt to tippet results in a powerful turnover of everything from big terrestrials to multi-fly rigs (i.e. hopper/copper/dropper). Also perfect for beginners.

LEADER AND TIPPET



PERFORM X TROUT LEADER

\$3.84 EACH

LENGTH	SIZE	TEST	CODE	SRP
7.5'	0X	16 LB	59030	\$6.99
	1X	14 LB	59031	\$6.99
	2X	11 LB	59032	\$6.99
	3X	9 LB	59033	\$6.99
	4X	7 LB	59034	\$6.99
	5X	5.5 LB	59035	\$6.99
	6X	3.5 LB	59036	\$6.99
9'	0X	16 LB	59040	\$6.99
	1X	14 LB	59041	\$6.99
	2X	11 LB	59042	\$6.99
	3X	9 LB	59043	\$6.99
	4X	7 LB	59044	\$6.99
	5X	5.5 LB	59045	\$6.99
	6X	3.5 LB	59046	\$6.99
10'	0X	16 LB	59050	\$6.99
	1X	14 LB	59051	\$6.99
	2X	11 LB	59052	\$6.99
	3X	9 LB	59053	\$6.99
	4X	7 LB	59054	\$6.99
	5X	5.5 LB	59055	\$6.99
	6X	3.5 LB	59056	\$6.99
7X	2.8 LB	59057	\$6.99	

This is your go-to leader for most situations. Umpqua Trout Leaders, in all three lengths, feature exclusive taper designs to ensure a perfect blend of power (heavy butt & strong taper) and delicacy (perfect tippet length).



PERFORM X POWER TAPER TROUT LEADER

\$3.84 EACH

LENGTH	SIZE	TEST	CODE	SRP
7.5'	2X	11 LB	59080	\$6.99
	3X	9 LB	59081	\$6.99
	4X	7 LB	59082	\$6.99
	5X	5.5 LB	59083	\$6.99
	6X	3.5 LB	59084	\$6.99
	9'	2X	11 LB	59085
3X		9 LB	59086	\$6.99
4X		7 LB	59087	\$6.99
5X		5.5 LB	59088	\$6.99
6X	3.5 LB	59089	\$6.99	

The strongest and fastest taper available. A quick transition from heavy, long butt to tippet results in a powerful turnover of everything from big terrestrials to multi-fly rigs (i.e. hopper/copper/dropper). Also perfect for beginners.



PERFORM X FINESSE LEADER

\$3.84 EACH

LENGTH	SIZE	TEST	CODE	SRP
13'	3X	9 LB	59075	\$6.99
	4X	7 LB	59076	\$6.99
	5X	5.5 LB	59077	\$6.99
	6X	3.5 LB	59078	\$6.99
	7X	2.8 LB	59079	\$6.99

Ideal for long, delicate presentations with small, technical flies. A dense, long butt and long taper ending with a long length of tippet results in ultra-smooth, stealthy, dead-drift for the flat water of spring creeks and stillwaters.

UMPQUA™ LEADER TAPERS

We have designed three tapered leaders to cover all of your trout-fishing needs. Choose the right Perform X leader for the right fly presentation:

Trout Taper (7.5', 9' & 10') A great combination of a strong taper paired with plenty of tippet length to achieve great drifts with most fly sizes and types. This is your go-to leader for most situations.



Power Taper (7.5' & 9') The strongest and fastest taper available. A quick transition from heavy butt to tippet results in a powerful turnover of everything from big terrestrials to multi-fly rigs (i.e. hopper/copper/dropper). New fly casters will also greatly benefit from this leader's strong turnover.



Finesse Taper (13') Ideal for long, delicate presentations with small, technical flies. A dense butt and long taper results in ultra-smooth, stealthy, dead-drift presentations in spring-creek conditions.



PERFORM X TROUT NYLON



PERFORM X HD STREAMER LEADER

\$3.84 EACH

LENGTH	SIZE	TEST	CODE	SRP
5'	.010"	8 LB	59101	\$6.99
	.011"	10 LB	59102	\$6.99
	.012"	12 LB	59103	\$6.99
	.013"	16 LB	59104	\$6.99
	.015"	20 LB	59105	\$6.99

Put and keep your streamers in the zone for more eats. A short leader lets your line decide where your fly fishes, making this the perfect connection to any sinking line or whenever stripping streamers.



POWER TAPER PRACTICE LEADER

\$4.13 EACH

LENGTH	SIZE	TEST	CODE	SRP
7.5'	3X	9 LB	59106	\$7.50

Perfect for shop demo rigs and casting classes. The bright line and contrasting indicator are ideal for those wanting to see their practice casts whether on water or grass. Curve casts, reach casts, s-curves—now you can really see and perfect them.



PERFORM X HOPPER LEADER

\$3.84 EACH

LENGTH	SIZE	TEST	CODE	SRP
7.5'	1X	14 LB	59110	\$6.99
	2X	11 LB	59111	\$6.99
	3X	9 LB	59112	\$6.99
	4X	7 LB	59113	\$6.99

Turn over those big, wind-resistant terrestrials! This taper uses a long, un-tapered butt section and aggressive taper-to-tippet to make casting hoppers into the wind a breeze. Guide approved!



PYRAMID LAKE STREAMER LEADER

\$7.14 EACH

LENGTH	SIZE	TEST	CODE	SRP
6'		12 LB	59115	\$12.99

Designed specifically for stripping multiple streamers from the beaches of Pyramid Lake. The 7" 12LB dropper tag at the 3' mark followed by another 3' of 12LB hard nylon allows for easy Woolly Worm, Boobie or streamer attachment.



PERFORM X NYLON BUTT MATERIAL

\$19.24

LENGTH	DIAMETER	TEST	CODE	SRP
200YD	0.021"	1-5 WT	59120	\$34.99
	0.024"	5-8WT	59121	

Our Umpqua Perform X HD Butt Material is the material of choice in Pro Shops across the country for adding leader-butts to flylines.

LEADER AND TIPPET

PERFORM X TACTICAL

TROUT NYLON



PERFORM X INDICATOR TIPPET

\$8.24 EACH

COLOR	SIZE	TEST	CODE	SRP
RED	03X	18.0 LB	59190	\$14.99
	0X	15 LB	59191	\$14.99
	2X	10.7 LB	59192	\$14.99
	3X	8.5 LB	59193	\$14.99
	4X	6.0 LB	59194	\$14.99

Two bright, visible colors alternate in 24" segments, allowing anglers to see easily when fish strike without requiring the use of a traditional attached indicator. Just tie it between your leader and tippet material for ultra-sensitive strike detection. Ideal for European nymphing methods!



UMPQUA™ INDICATOR COIL 6' 2-PACK

\$7.14 EACH

COLORS	SIZE	CODE	SRP
YELLOW/PINK	03X 18 LB	59185	\$12.99
YELLOW/RED	03X 18 LB	59186	\$12.99

Using the same bright alternating colors as our indicator tippet, this coil lets an angler see a strike without tension building in the line. Micro perfection loops at both ends allow for easy attachment.



PERFORM X HOT POWER TAPERED LEADER 10'

\$3.84
EACH

COLOR	SIZE	TEST	CODE	SRP
MILK/PINK	3X	9 LB	59175	\$6.99
	4X	7 LB	59176	\$6.99
	5X	5.5 LB	59177	\$6.99
MILK/RED	3X	9 LB	59178	\$6.99
	4X	7 LB	59181	\$6.99
	5X	5.5 LB	59182	\$6.99
	6X	3.5 LB	59183	\$6.99

This 10' leader is the only one on the market to feature a vivid neon red section integrated into the taper. The first 36" of butt section is a matte-milky color for maximum contrast. The next 24" of butt is the high-vis neon pink or red indicator section for maximum contrast.

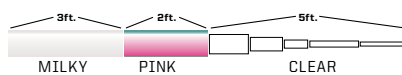

UMPQUA™ PREMIUM TIPPET RINGS 10-PACK

\$8.24 EACH

CODE	COST	SRP
59195	\$5.49	\$14.99

The easy & effective way to connect a tippet to a leader. Simply knot your leader/tippet to the tippet ring before sliding the ring off of the wire.

- 2mm Diameter
- High Strength (26lb)
- Smooth Polish - will not weaken line
- Corrosion Resistant
- Anodized, High Grade Alloy
- Low Reflection

PERFORM X EURO TROUT NYLON

NEW



PERFORM X HI-VIZ BUTT MATERIAL

\$10.99 EACH

COLOR	LENGTH	SIZE	TEST	CODE	SRP
FL ORANGE	30YD	.013" HEAVY	16 LB	59386	\$19.99
	30YD	.011" MEDIUM	12 LB	59387	\$19.99
	30YD	.007" MICRO	06 LB	59388	\$19.99
FL PINK	30YD	.013" HEAVY	16 LB	59389	\$19.99
	30YD	.011" MEDIUM	12 LB	59390	\$19.99
	30YD	.007" MICRO	06 LB	59391	\$19.99
FL GREEN	30YD	.013" HEAVY	16 LB	59392	\$19.99
	30YD	.011" MEDIUM	12 LB	59393	\$19.99
	30YD	.007" MICRO	06 LB	59394	\$19.99

These Hi-Viz monofilament lines give anglers the opportunity to build European-Nymphing leader setups exactly to their liking with a multitude of color and thickness options. Available in hot-pink, hot-orange, and hot-green, there is an option suited for any condition or personal preference.

NEW



PERFORM X EGAN'S EURO LEADER

\$8.24 EACH

COLOR	LENGTH	SIZE	TEST	CODE	SRP
HT ORANGE	14'	0X-HEAVY	16 LB	59395	\$14.99
HT PINK	14'	2X-MEDIUM	12 LB	59396	\$14.99
HT GREEN	14'	4X-MICRO	06 LB	59397	\$14.99

Umpqua has collaborated with longstanding Team USA Fly Fishing member Lance Egan, one of the foremost authorities on European-Nymphing tactics in the U.S., to develop a brand-new line of leaders suited for all anglers interested in this style of fishing. Whether you are a complete novice, a championship-level competitor, or you just want a do-it-all leader for any Euro-Nymphing scenario, there is a hand-tied setup in this new lineup for you.

NEW



PERFORM X SIGHTER TIPPET

\$8.24 EACH

COLOR	LENGTH	SIZE	TEST	CODE	SRP
PNK/YEL	15YD	02X HVY	14 LB	59398	\$14.99
		2X MED		59399	\$14.99
		4X MICRO		59400	\$14.99
RED/GRN		02X HVY		59401	\$14.99
		2X MED		59402	\$14.99
		4X MICRO		59403	\$14.99
PNK/BK/YEL		02X HVY		59404	\$14.99
		2X MED		59405	\$14.99
		4X MICRO		59406	\$14.99
RED/BK/GRN		02X HVY		59407	\$14.99
		2X MED		59408	\$14.99
		4X MICRO		59409	\$14.99

Umpqua's new indicator tippet was designed specifically for modern European-Nymphing techniques in order to give anglers a variety of choices to suit their preferences and the demands of the water without overcomplicating the process. This new material is available in two- and three-toned configurations.

NEW



UMPQUA™ TIPPET RINGS STD 10-PACK

\$4.12 EACH

CODE	SRP
59197	\$7.49

The easy & effective way to connect a tippet to a leader. Simply knot your leader/tippet to the tippet ring before sliding the ring off of the wire.

- 2mm Diameter
- High Strength (26lb)
- Smooth Polish - will not weaken line
- Corrosion Resistant
- Japanese Stainless Steel, Black Nickel Finish
- Low Reflection

LEADER AND TIPPET



FLIES

LEADER & TIPPET

PACKS & BAGS

ACCESSORIES

HOOKS

TOOLS & KITS

TYING MATERIALS

NECKS & SADDLES



UMPQUA
www.umpqua.com

4X FLY SIZE:
#10-16



7LB
3.2KG
50YD
45.7M
0.007"/0.18mm

DECEIVER X
FLUOROCARBON
made in Japan

DECEIVER X TROUT FLUOROCARBON

LEGENDARY DECEIVER STRENGTH AND INVISIBILITY

With Best-In-Class knot-strength, abrasion resistance and ultra-low visibility, Deceiver X is the premium standard in fluorocarbon material. Deceiver X pays tribute to the original & first fluorocarbon tippet brought to fly-fishing 20 years ago, Umpqua Deceiver. Now on a 50-yard spool, Deceiver X also offers the best value in premium FC material.

DECEIVER X CONSTRUCTION

Forged Core | Increased density for the same Diameter- increased strength by 10%

Coating 1 | Low memory, increased knot strength and seating

Coating 2 | Hard Surface treatment for incredible abrasion resistance

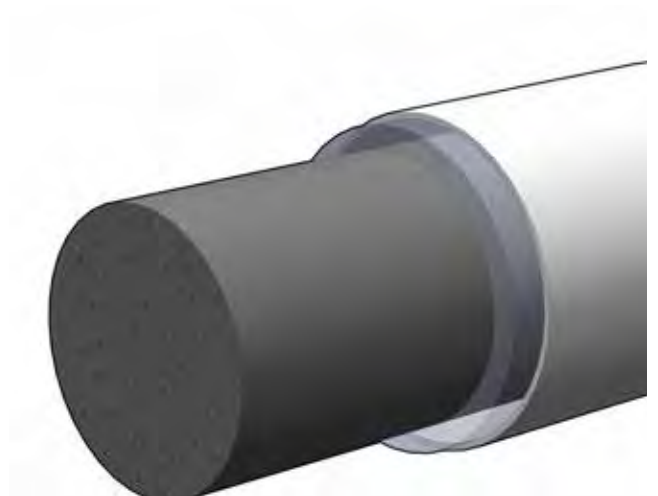

DECEIVER X TROUT FLOUROCARBON



**DECEIVER X
FLURO TIPPET**

\$8.24 EACH (50YD) \$16.49 EACH (100YD)

YARDS	SIZE	TEST	DIA.	CODE	SRP
50	0X	15 LB	.011"	59130	\$14.99
	1X	13 LB	.010"	59131	\$14.99
	2X	11 LB	.009"	59132	\$14.99
	3X	8.5 LB	.008"	59133	\$14.99
	4X	7 LB	.007"	59134	\$14.99
	5X	5 LB	.006"	59135	\$14.99
	6X	4 LB	.005"	59136	\$14.99
	7X	2.5 LB	.004"	59137	\$14.99
GUIDE SPOOL					
100	2X	11 LB	.009"	59140	\$29.99
	3X	8.5 LB	.008"	59141	\$29.99
	4X	7 LB	.007"	59142	\$29.99
	5X	5 LB	.006"	59143	\$29.99
	6X	4 LB	.005"	59144	\$29.99



**DECEIVER X
FLURO LEADER**

\$7.14 EACH

LENGTH	SIZE	TEST	DIA.	CODE	SRP
7.5'	2X	11 LB	.009"	59160	\$12.99
	3X	8.5 LB	.008"	59161	\$12.99
	4X	7 LB	.007"	59162	\$12.99
	5X	5 LB	.006"	59163	\$12.99
9'	2X	11 LB	.009"	59165	\$12.99
	3X	8.5 LB	.008"	59166	\$12.99
	4X	7 LB	.007"	59167	\$12.99
	5X	5 LB	.006"	59168	\$12.99
	6X	4 LB	.005"	59169	\$12.99

This is your go-to leader when stealth is critical. These Trout Leaders, in all lengths, feature exclusive taper designs to ensure a perfect blend of stealth, power and delicacy...with legendary Deceiver strength and stealth.

“When I flip the lid to my boat bag, at the very top are my spools of tippet and packs of leaders. Stacks of Perform X and Deceiver X in 0X-6X, with some 10lb-25lb Deceiver HD in there for the fun stuff. I never want to worry about my gear. I know all the pieces fit together and everything has a place and a purpose during my day. The confidence I have for my leaders and tippet has to be unwavering, it’s how I make my day.

Confidence comes with testing- when and how will it break? Will it turn flies over? Is it catching fish on crystal clear rivers? After countless days on the water one starts to build a familiarity with his/her equipment. Abrasion resistance, knot strength, low stretch and invisibility are all on my radar with my tippet. Having a great day with a product will give you all the confidence and peace of mind you’ll ever need.

Not all 5x is created equal.”

JUSTIN CARR / 200 DAY BOAT GUIDE WITH VAIL VALLEY ANGLERS IN EDWARDS, CO

LEADER AND TIPPET

BOX FLY SIZE:
#16-22



FLIES

LEADER & TIPPET

PACKS & BAGS

ACCESSORIES

HOOKS

TOOLS & KITS

TYING MATERIALS

NECKS & SADDLES

UMPQUA
www.umpqua.com

4LB
1.814 kg
30YD
27.14 m
0.005" / 0.13 mm

6X FLY SIZE:
#16-22



PHANTOM X
ULTRA FLUOROCARBON
made in korea

PHANTOMX ULTRA FLUOROCARBON

NEVER SEEN BEFORE, STRENGTH, SENSITIVITY & INVISIBILITY

Simply put, Umpqua's Phantom X is the strongest and most invisible fluorocarbon tippet on the market. And with very little stretch, Phantom X allows you to detect the most subtle takes. A unique chemical process of combining FC monomers into polymer chains results in abrasion resistance, sensitivity, density, invisibility and strength never seen before in FC tippet.

- Core | Ultra Low Stretch Fluoro** Increased sensitivity and strike detection
- Outer Core | Low Memory Fluoro** Suppleness for maximum presentation
- Coating 1 | Soft Coat** Increased knot strength and improved knot seating
- Coating 2 | Phantom Coat** Maximum invisibility with decreased light reflection
- Coating 3 | HD Coat** 25% more abrasion resistance over other materials

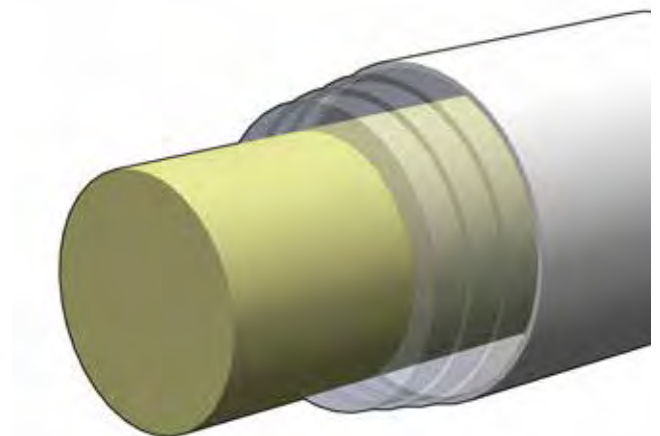

PHANTOM X ULTRA FLUOROCARBON



PHANTOM X FLUORO TIPPET

\$10.99 EACH
(30YD)

YARDS	SIZE	TEST	DIA.	CODE	SRP
30	0X	16 LB	0.011"	59150	\$19.99
	1X	13 LB	0.010"	59151	\$19.99
	2X	11 LB	0.009"	59152	\$19.99
	3X	9 LB	0.008"	59153	\$19.99
	4X	7.2 LB	0.007"	59154	\$19.99
	5X	5.5 LB	0.006"	59155	\$19.99
	6X	4 LB	0.005"	59156	\$19.99
	7X	3 LB	0.004"	59157	\$19.99



PHANTOM X EURO LEADER 20'

\$8.24 EACH

LENGTH	SIZE	TEST	CODE	SRP
20'	4X	7.2 LB	59170	\$14.99
	5X	5.5 LB	59171	\$14.99
	6X	4 LB	59172	\$14.99

A leader designed specifically for Euro Nymphing. Built to fish in changing conditions and a variety of techniques from dry dropper to jigging streamers. It fishes well with lightly weighted nymphs or heavy bombs at long and short range. Tipped with our new Phantom X Fluorocarbon this leader is a deadly leader for this unique style of fishing.

Presentation matters. Many would argue that it is the most important aspect of catching tough fish. And, while we can't stop you from wading into prime holding water or epically botching your reach cast, we can help you match the right leader/tippet to the right fly and situation.

LEADER AND TIPPET

ATOM X
FLUOROCARBON



EURO LEADER

SIZE: 8-20

6X 20FT
6.1m

0.5LB // 2.5KG

FLIES

LEADER & TIPPET

PACKS & BAGS

ACCESSORIES

HOOKS

TOOLS & KITS

TYING MATERIALS

NECKS & SADDLES



LEADER AND TIPPET

HEAVY [HD] DUTY

HEAVY DUTY (HD) TO GET DOWN-AND-DIRTY

Confidence matters, and Umpqua's Perform X HD will be there for you when throwing big bugs into dense cover, dredging deep for chrome or casting directly into a tropical trade wind. Perform X HD and Deceiver HD has the perfect mass and moderate stiffness to turn over big bugs and the abrasion resistance to handle the often violent aftermath of the take.

HD CONSTRUCTION

We take the innovation that we have put into our X rated products and re-formulate them to specific needs of anglers.

Core | Moderately stiff core to ensure positive energy delivery

Coating 1 | Low memory, increased knot strength and seating

Coating 2 | Hard Surface treatment for incredible abrasion resistance

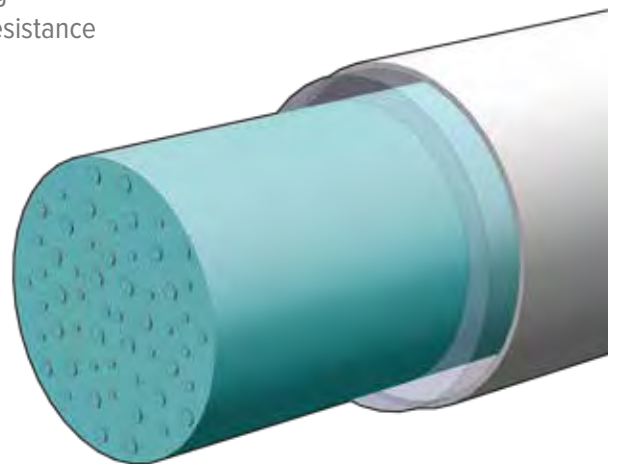

WARMWATER



PERFORM X HD WARMWATER TIPPET

\$3.84 EACH

YARDS	SIZE	TEST	CODE	SRP
30	.010"	8 LB	59200	\$6.99
	.011"	10 LB	59201	\$6.99
	.012"	12 LB	59202	\$6.99
	.015"	16 LB	59203	\$6.99
	.017"	20 LB	59204	\$6.99
	.019"	25 LB	59205	\$6.99
	.022"	30 LB	59206	\$6.99

Confidence matters, and Umpqua's Perform X HD will be there for you when throwing big bugs into dense cover. Perform X HD has the perfect mass and moderate stiffness to turn over big bass bugs and the abrasion resistance to handle the often violent aftermath of the take.



PIKE/MUSKIE LEADER W/TYGER WIRE TIP 8'/30LB.

\$10.99 EACH

LENGTH	TEST	CODE	SRP
8'	30LB	59230	\$19.99

When we set out to make the absolute best leader for Pike and Muskie, there was only one choice..... TyGer wire. TyGer wire allows any favorite knot to be easily tied. This leader has 6 feet of hard nylon connected to 18" of 30 lb. TyGer wire tippet with a hand tied Albright knot.



PERFORM X HD BASS LEADER

\$3.84 EACH

LENGTH	SIZE	TEST	CODE	SRP
5'	.010"	8 LB	59210	\$6.99
	.011"	10 LB	59211	\$6.99
	.012"	12 LB	59212	\$6.99
	.015"	16 LB	59213	\$6.99
	.017"	20 LB	59214	\$6.99
8'	.010"	8 LB	59215	\$6.99
	.011"	10 LB	59216	\$6.99
	.012"	12 LB	59217	\$6.99
	.015"	16 LB	59218	\$6.99
	.017"	20 LB	59219	\$6.99

Our Bass Leaders are built to deliver big wind resistant flies accurately into tight cover and have the strength to muscle them out of heavy cover. A perfect combination of mass, abrasion resistance and strength.



PERFORM X HD CARP LEADER

\$3.84 EACH

LENGTH	SIZE	TEST	CODE	SRP
12'	.010"	8 LB	59220	\$6.99
	.011"	10 LB	59221	\$6.99
	.012"	12 LB	59222	\$6.99
	.015"	16 LB	59223	\$6.99
	.017"	20 LB	59224	\$6.99

12 feet of our most abrasion-resistant material is the perfect combination of length, stealth and strength to tackle one of the world's most resilient and tenacious fish. A perfect combination of mass, abrasion resistance and strength.



DECEIVER HD CARP LEADER FLUOROCARBON

\$7.14 EACH

LENGTH	SIZE	TEST	CODE	SRP
12'	.010"	8 LB	59225	\$12.99
	.011"	10 LB	59226	\$12.99
	.012"	12 LB	59227	\$12.99
	.013"	16 LB	59228	\$12.99
	.014"	20 LB	59229	\$12.99

12 feet of our most abrasion-resistant material, the Deceiver HD Carp Taper is the perfect combination of length, stealth and strength to tackle one of the world's most resilient and tenacious fish...with legendary Deceiver strength and stealth.

LEADER AND TIPPET

ANADROMOUS



PERFORM X HD SALMON/ STEELHEAD LEADER

\$3.84 EACH

LENGTH	SIZE	TEST	CODE	SRP
5'	.010"	8 LB	59240	\$6.99
	.011"	10 LB	59241	\$6.99
	.012"	12 LB	59242	\$6.99
	.015"	16 LB	59243	\$6.99
	.017"	20 LB	59244	\$6.99
8'	.010"	8 LB	59245	\$6.99
	.011"	10 LB	59246	\$6.99
	.012"	12 LB	59247	\$6.99
	.015"	16 LB	59248	\$6.99
	.017"	20 LB	59249	\$6.99
10'	.010"	8 LB	59250	\$6.99
	.011"	10 LB	59251	\$6.99
	.012"	12 LB	59252	\$6.99
	.015"	16 LB	59253	\$6.99
	.017"	20 LB	59254	\$6.99

Our Salmon/Steelhead Leaders are perfect for fishing varying conditions on your anadromous rivers. The longer versions are ideal for swinging traditional wets to steelhead/salmon on a floating line while the 5' length is great for intruder style flies on heavy sink tips.



PERFORM X HD SALMON/ STEELHEAD NYLON TIPPET

\$3.84 EACH

YARDS	SIZE	TEST	CODE	SRP
30	.010"	8 LB	59231	\$6.99
	.011"	10 LB	59232	\$6.99
	.012"	12 LB	59233	\$6.99
	.015"	16 LB	59234	\$6.99
	.017"	20 LB	59235	\$6.99
	.019"	25 LB	59236	\$6.99
	.022"	30 LB	59237	\$6.99

Confidence matters, and Umpqua's Perform X HD will be there for you when throwing big bugs into dense cover, dredging deep for chrome or casting directly into a tropical trade wind. Perform X HD has the perfect mass and moderate stiffness to turn over big bugs and the abrasion resistance to handle the often violent aftermath of the take.



DECEIVER HD SALMON/ STEELHEAD LEADER FLUOROCARBON

\$7.14 EACH

LENGTH	SIZE	TEST	CODE	SRP
12'	.010"	8 LB	59255	\$12.99
	.011"	10 LB	59256	\$12.99
	.012"	12 LB	59257	\$12.99
	.013"	16LB	59258	\$12.99
	.015"	20 LB	59259	\$12.99

12 feet of our most abrasion-resistant and invisible material is perfect for low clear water or high pressure rivers where presentation is paramount. Tie on your traditional irons and get greasy.

FLIES

LEADER & TIPPET

PACKS & BAGS

ACCESSORIES

HOOKS

TOOLS & KITS

TYING MATERIALS

NECKS & SADDLES

PERFORM X HD SALTWATER



PERFORM X HD ALL-PURPOSE SALTWATER LEADER

\$3.84 EACH

LENGTH	SIZE	TEST	CODE	SRP
9'	.011"	10 LB	59320	\$6.99
	.012"	12 LB	59321	\$6.99
	.015"	16 LB	59322	\$6.99
	.017"	20 LB	59323	\$6.99
	.019"	25 LB	59324	\$6.99
12'	.021"	30 LB	59325	\$6.99
	.023"	35 LB	59326	\$6.99
	.024"	40 LB	59327	\$6.99

An extra-long, heavy butt-section partnered with our highly abrasion-resistant Perform X HD nylon gives you the perfect all-around leader for salt. Turn over bigger flies in strong winds for the best possible saltwater presentation.



PERFORM X HD BONEFISH LEADER

\$3.84 EACH

LENGTH	SIZE	TEST	CODE	SRP
10'	.010"	8 LB	59340	\$6.99
	.011"	10 LB	59341	\$6.99
	.012"	12 LB	59342	\$6.99
12'	.015"	16 LB	59343	\$6.99
	.010"	8 LB	59345	\$6.99
	.011"	10 LB	59346	\$6.99
	.012"	12 LB	59347	\$6.99
	.015"	16 LB	59348	\$6.99

Chase the ghost of the flats with extreme accuracy and power by tying on a Perform X HD Bonefish Leader (in 10' & 12'). A long, heavy butt section and dense, medium-stiff material provide a strong but controlled presentation and extreme abrasion-resistance will bring the fish to hand.



\$3.29 EACH

PERFORM X HD SALTWATER NYLON TIPPET

YARDS	SIZE	TEST	CODE	COST	SRP
35	.010"	8 LB	59310	\$3.84	\$6.99
	.011"	10 LB	59311	\$3.84	\$6.99
	.012"	12 LB	59312	\$3.84	\$6.99
25	.015"	16 LB	59313	\$3.84	\$6.99
	.017"	20 LB	59314	\$3.84	\$6.99
	.019"	25 LB	59315	\$3.84	\$6.99
15	.021"	30 LB	59316	\$3.84	\$6.99
	.023"	35 LB	59317	\$3.84	\$6.99
	.024"	40 LB	59318	\$3.84	\$6.99

Umpqua's Perform X HD Tippet is a clear, medium hard, moderately stiff "tippet" made from the strongest and most abrasion-resistant nylon. Whether stripping small bonefish flies over coral bottoms or casting large 4/0 deceivers, this is the perfect leader material for the rigors of saltwater conditions.

LEADER AND TIPPET



PERFORM X HD TYGER TIPPED WIRE LEADER

\$10.99 EACH

LENGTH	TEST	CODE	SRP
8'	30 LB	59365	\$19.99

When we set out to make the absolute best leader for toothy saltwater fish, there was only one choice—Tyger™ wire. Tyger Leader™ allows any favorite knot to be easily tied. 6 ft. of hard nylon professionally albrighted to 18 in. of Tyger™ wire tippet. The very best choice for Bluefish, Barracuda, etc...



PERFORM X HD REDFISH LEADER

\$3.84 EACH

LENGTH	SIZE	TEST	CODE	SRP
9'	.011"	10 LB	59330	\$6.99
	.012"	12 LB	59331	\$6.99
	.015"	16 LB	59332	\$6.99
	.017"	20 LB	59333	\$6.99
	.019"	25 LB	59334	\$6.99
	.021"	30 LB	59335	\$6.99

Turn over big Redfish flies with ease in strong winds with the Perform X HD Redfish Leader. A long, heavy butt section and dense, medium-stiff material transfer the momentum of your cast straight to the fly until kicked over.



PERFORM X HD SALTWATER PRACTICE LEADER

\$4.13 EACH

LENGTH	TEST	CODE	SRP
9'	12 LB	59367	\$7.50

The one thing all guides recommend before a saltwater fishing trip is, "practice your casting." And to aid your practice casting, a bright neon leader can offer, for the first time, a highly visual picture of the entire cast—from rod to line to leader to fly.



PERFORM X HD STRIPER LEADER

\$3.84 EACH

LENGTH	SIZE	TEST	CODE	SRP
8'	.011"	10 LB	59350	\$6.99
	.012"	12 LB	59351	\$6.99
	.015"	16 LB	59352	\$6.99
	.017"	20 LB	59353	\$6.99

Turn over wind-resistant striper flies with ease in heavy winds with the Perform X HD Striper Leader. A long, heavy butt section and dense, medium-stiff material transfer the momentum of your cast straight to the fly and deliver accurately.



PERFORM X HD SALTWATER SHOCK TIPPET

\$10.99 EACH

YARDS	SIZE	TEST	CODE	SRP
25	.026"	40	59355	\$19.99
	.028"	50	59356	\$19.99
	.032"	60	59357	\$19.99
	.035"	80	59358	\$19.99



PERFORM X HD BUTT MATERIAL

\$19.24 EACH

YARDS	TEST	DIA.	CODE	SRP
200 YD	7-9 WT	.026"	59362	\$34.99
	10-12 WT	.028"	59363	

Our Umpqua Perform X HD Butt Material is the material of choice in Pro Shops across the country for adding leader-butts to flylines.

FLIES

LEADER & TIPPET

PACKS & BAGS

ACCESSORIES

HOOKS

TOOLS & KITS

TYING MATERIALS

NECKS & SADDLES

PERFORM X HD SALTWATER



THINK PINK

LEADER AND TIPPET

NEW

DECEIVER HD PINK BIG GAME FLUORO TIPPET

YARDS	SIZE	TEST	CODE	COST	SRP
25	8 LB	.010"	59372	\$8.24	\$14.99
	10 LB	.011"	59373	\$8.24	\$14.99
	12 LB	.012"	59374	\$8.24	\$14.99
	16 LB	.013"	59375	\$9.89	\$17.99
	20 LB	.015"	59376	\$9.89	\$17.99
	25 LB	.018"	59377	\$10.99	\$19.99
	30 LB	.020"	59378	\$10.99	\$19.99
	35 LB	.023"	59379	\$13.74	\$24.99
	40 LB	.025"	59380	\$13.74	\$24.99



DECEIVER HD PINK SHOCK BIG GAME FLUORO TIPPET



DECEIVER HD FLUORO PINK SHOCK TIPPET

LENGTH	TEST	SIZE	CODE	PRICE	SRP
PINK FLUOROCARBON					
25YD	40LB	.024"	59305	\$16.49	\$29.99
	50LB	.026"	59306	\$19.24	\$34.99
	60LB	.029"	59307	\$21.99	\$39.99
	80LB	.036"	59308	\$24.74	\$44.99

Protect class tippet with either our unique pink fluorocarbon shock-tippet or our proven clear Deceiver HD clear Fluorocarbon shock tippet to deceive leader-shy fish.

FLIES

LEADER & TIPPET

PACKS & BAGS

ACCESSORIES

HOOKS

TOOLS & KITS

TYING MATERIALS

NECKS & SADDLES

DECEIVER HD SALTWATER FLUORO



DECEIVER HD BIG GAME FLUORO LEADER

\$7.14 EACH

LENGTH	TEST	SIZE	CODE	SRP
9'	8LB	.010"	59270	\$12.99
	10LB	.011"	59271	\$12.99
	12LB	.012"	59272	\$12.99
	16LB	.013"	59273	\$12.99
	20 LB	.015"	59274	\$12.99
12'	8LB	.010"	59280	\$12.99
	10LB	.011"	59281	\$12.99
	12LB	.012"	59282	\$12.99
	16LB	.013"	59283	\$12.99
	20LB	.015"	59284	\$12.99

Casting power, near invisibility, fast sink rate, this leader is ideal for big critters that swim in fresh and salt. Tie on your flies and confidently make your cast knowing you are geared up for anything.



TARPON LEADER W/ PINK FLUORO SHOCK

\$10.99 EACH

2-PACK

LENGTH	CLASS	SHOCK	CODE	SRP
10'	16 LB	60 LB	59295	\$19.99
10'	20 LB	80 LB	59296	\$19.99

Umpqua's Tarpon leader combines ultra-deceptive pink fluorocarbon shock tippet securely attached (Bimini/Huffnagle) to a strongly tapered clear nylon Perform X HD leader. Simply loop the leader to the fly line and tie on a fly. A heavy butt and strong knotless taper improves turnover in the wind, class tippet protects gear and fish, and the unique pink fluorocarbon shock-tippet deceives leader-shy fish while protecting class tippet.



BACKCOUNTRY LEADER W/ FLUORO SHOCK

\$8.24 EACH

LENGTH	CLASS	CODE	SRP
9'	16 LB CLASS/ 40 LB SHOCK	59290	\$14.99
	20 LB CLASS/ 40 LB SHOCK	59291	\$14.99

Our Backcountry Leader is hand-tied for baby Tarpon, Snook, etc... Looped 0.028" butt and 24" shock of 100% Deceiver HD Fluorocarbon. A workhorse leader for saltwater.



DECEIVER HD FLUORO SHOCK TIPPET

LENGTH	TEST	SIZE	CODE	PRICE	SRP
CLEAR FLUOROCARBON					
25YD	40LB	.024"	59300	\$16.49	\$29.99
	50LB	.026"	59301	\$19.24	\$34.99
	60LB	.029"	59302	\$21.99	\$39.99
	80LB	.036"	59303	\$24.74	\$44.99
PINK FLUOROCARBON					
25YD	40LB	.024"	59305	\$16.49	\$29.99
	50LB	.026"	59306	\$19.24	\$34.99
	60LB	.029"	59307	\$21.99	\$39.99
	80LB	.036"	59308	\$24.74	\$44.99

Protect class tippet with either our unique pink fluorocarbon shock-tippet or our proven clear Deceiver HD clear Fluorocarbon shock tippet to deceive leader-shy fish.

LEADER AND TIPPET



DECEIVER HD BIG GAME FLUORO TIPPET

YARDS	SIZE	TEST	CODE	COST	SRP
25	8 LB	.010"	59260	\$8.24	\$14.99
	10 LB	.011"	59261	\$8.24	\$14.99
	12 LB	.012"	59262	\$8.24	\$14.99
	16 LB	.013"	59263	\$9.89	\$17.99
	20 LB	.015"	59264	\$9.89	\$17.99
	25 LB	.018"	59265	\$10.99	\$19.99
	30 LB	.020"	59266	\$10.99	\$19.99
	35 LB	.023"	59267	\$13.74	\$24.99
	40 LB	.025"	59268	\$13.74	\$24.99



DECEIVER HD BONEFISH / PERMIT FLUORO LEADER

\$7.14 EACH

LENGTH	TEST	DIA.	CODE	SRP
12'	8 LB	.010"	59285	\$12.99
	10 LB	.011"	59286	\$12.99
	12 LB	.012"	59287	\$12.99
	16 LB	.013"	59288	\$12.99
	20 LB	.014"	59289	\$12.99

An extra-long, heavy butt section partnered with our highly abrasion-resistant Deceiver HD Fluorocarbon gives you the perfect all-around leader for salt. Turn over bigger flies in strong winds or delicately place a blind Charlie on the nose for the best possible saltwater presentation.



FLIE SELECTIONS

LEADER & TIPPET

PACKS & BAGS

ACCESSORIES

HOOKS

TOOLS & KITS

TYING MATERIALS

NECKS & SADDLES



PACKS, BAGS & ORGANIZERS

The logo features the letters 'ZS' in a bold, sans-serif font, with a trademark symbol (TM) to the upper right. The text is centered within a dark olive-green silhouette of a mountain range with two peaks.

The evolution of Umpqua's ZeroSweep™ line continues with the ZS2 line of packs and bags. Built on the clean design of our original ZeroSweep™ packs, we've added customization to create the perfect system for you. ZS2 keeps your tools out of the way of lines and snags while our molle webbing allows you to unbury features you need at the ready. Create your perfect carry system with ZS2.

ACCESSORIES

With the addition of a whole line of essential accessories, the ZS2 molle integration system allows you to put any one of the following accessories front and center (or wherever you'd like it) for easy access on most of our packs:

- Gel Floatant Holder
- Shimi Shake Holder
- Tippet Holder
- Foam Fly Patch
- Net Quiver
- Water Bottle Holder
- Wader Chest Pack
- Roll-Top Wader Chest Pack
- Gel Floatant Holder w/ Dry magic
- Shimi Shake Floatant Holder w/ Shimi

ZS2 Packs – Have it your way!

WADER TOTE

Full-featured tote to handle gearing up, gearing down and storing your boots and waders. Load this tote up with your waders, water bottle, etc., and you are ready to grab-and-go when the bite is on.

35283 OLIVE

\$65.99 COST
\$119.99 SRP



WADER TOTE^{ZS2}

FEATURES

- A full-sized 22"x16" fold-out quilted/padded stand-station while gearing up.
- When stowed, the pad creates the perfect location to stow rod tubes and nets.
- Full-sized mesh water-bottle pocket
- 2x4 Molle Panel – compatible with all ZS2 accessories
- 2 mesh panels on lid for ventilation/drying
- 3 internal flat pocket
- Shoulder strap
- Grab handle with Velcro overwrap
- Dimensions = 20"x10"x14"
- Volume = 2800 cubic inches, 45 liters

PACKS, BAGS & ORGANIZERS



FLIES

LEADER & TIPPET

PACKS & BAGS

ACCESSORIES

HOOKS

TOOLS & KITS

TYING MATERIALS

NECKS & SADDLES

LEDGES PACKS

The ultimate fly-fishing beast-of-burden, the Ledges 650's stiff back-panel and padded waist belt provide all-day comfort and easy rotation. The main pocket easily holds 4 standard fly boxes. Two zippered and stretch-mesh pockets up front will handle more boxes or any accessories you need. A hemostat sheath (a favorite feature) also makes stowing and accessing your hemostats painless. A few nice surprises – an integrated net slot for easy storage/access and two zippered pockets on the waist belt



LEDGES^{ZS2} 650 WAIST PACK

FEATURES

- Net Slot – between back panel & pack body
- 2 x ZS Retractor Stations – with hypalon attachment bands
- 1 x Hemostat/Tool Sheath – allows easy & “blind” access
- 1 x ZS Foam Fly Patch Station – includes foam fly patch
- 1 x ZS Cord Tippet Holder – “Stowable” when not in use
- 1 x Key Clip
- Shoulder Strap w/Floating Pad
- 3 x Molle Modular Attachment Station – compatible with the following ZS2 accessories (sold separately):
 1. ZS2 Foam Fly Patch
 2. ZS2 Gel Floatant Holder
 3. ZS2 Shimi Shake Floatant Holder
 4. ZS2 Tippet Holder
 5. ZS2 Water Bottle Holder (included)
 6. ZS2 Net Holder
- Closed-foot zipper sliders (minimize line-snap)
- YKK Zippers
- **Fabric**
Body fabric - 420 denier nylon
High wear locations – Ballistic Nylon



35255 OLIVE

\$82.49 COST
\$149.99 SRP

DIMENSIONS
LENGTH 11 IN.
WIDTH 8 IN.
HEIGHT 10 IN.

CAPACITY
650 CUBIC IN

PACKS, BAGS & ORGANIZERS



The Ledges 500 carries everything you need along with a few surprises. A stiff & well-padded back-panel and waist belt provide all-day comfort and easy rotation. The main compartment holds 4 large fly boxes and stretch mesh pockets on the face are great for accessories. A nice surprise – integrated net slot and hemostat sheath for easy storage and access.

LEDGES^{ZS2} 500 WAIST PACK

FEATURES

- Net Slot – between back panel & pack body
- 2 x ZS Retractor Stations – with hypalon attachment bands
- 1 x Hemostat/Tool Sheath – allows easy & “blind” access
- 1 x ZS Foam Fly Patch Station – includes foam fly patch
- 1 x ZS Cord Tippet Holder – “Stowable” when not in use
- 1 x Key Clip
- Shoulder Strap w/Floating Pad
- 3 x Molle Modular Attachment Station – compatible with the following ZS2 accessories (sold separately):
 1. ZS2 Foam Fly Patch
 2. ZS2 Gel Floatant Holder
 3. ZS2 Shimi Shake Floatant Holder
 4. ZS2 Tippet Holder
 5. ZS2 Water Bottle Holder
 6. ZS2 Net Holder
- Closed-foot zipper sliders (minimize line-s snag)
- YKK Zippers
- Fabric
 - Body fabric - 420 denier nylon
 - High wear locations – Ballistic Nylon



35253 OLIVE

\$65.99 COST
\$119.99 SRP

DIMENSIONS
LENGTH 11 IN.
WIDTH 5 IN.
HEIGHT 8 IN.

CAPACITY
500 CUBIC IN



CHEST PACKS



Neck strain and visibility are always a compromise with chest packs. The Overlook resolves both with a 4-point harness attachment and sleek, tapered face. And, with this kit, you can choose from two back options, a flat mesh back and a full 550 cubic inch back with net holster. And, all of the great ZeroSweep features come along for the ride. Two ZeroSweep™ retractor stations (great for nipper and floatant attachment), ambidextrous hemostat station, foam fly patch and tippet holder cover all your key accessories. ZS2 version now includes a molle modular attachment station allowing integration with ZS2 accessories. Two stretch mesh pockets round out the storage possibilities.



OVERLOOK^{ZS2} 500 CHEST PACK KIT

FEATURES

- 4-Point harness attachment for all-day comfort
- 2 x ZS Retractor Stations – with hypalon attachment bands
- 2 x ZS Hemostat Grab Tabs – ambidextrous
- 1 x ZS Foam Fly Patch Station – includes foam fly patch
- 1 x ZS Cord Tippet Holder – “Stowable” when not in use
- 1 x Molle Modular Attachment Station – compatible with the following ZS2 accessories (sold separately):
 1. ZS2 Foam Fly Patch
 2. ZS2 Gel Floatant Holder
 3. ZS2 Shimi Shake Floatant Holder
 4. ZS2 Tippet Holder
 5. ZS2 Water Bottle Holder
- Closed-foot zipper sliders (minimize line-s snag)
- YKK Zippers



35257 OLIVE

\$87.99 COST
\$159.99 SRP

DIMENSIONS
LENGTH 12 IN.
WIDTH 5 IN.
HEIGHT 9 IN.

CAPACITY
500 CUBIC IN

PACKS, BAGS & ORGANIZERS

Thanks to ZeroSweep design, this small but mighty chest pack is packed full of features and functionality. The main compartment easily holds two standard fly boxes. Two ZeroSweep™ retractor stations (great for nipper and floatant attachment), ambidextrous hemostat station, foam fly patch and tippet holder cover all your key accessories. ZS2 version now includes a molle modular attachment station allowing integration with ZS2 accessories. Two stretch mesh pockets round out the storage possibilities.

ROCK CREEK^{ZS2} COMPACT CHEST PACK

FEATURES

- 4-Point harness attachment for all-day comfort
- 2 x ZS Retractor Stations – with hypalon attachment bands
- 2 x ZS Hemostat Grab Tabs – ambidextrous
- 1 x ZS Foam Fly Patch Station – includes foam fly patch
- 1 x ZS Cord Tippet Holder – “Stowable” when not in use
- 1 x Molle Modular Attachment Station – compatible with the following ZS2 accessories (sold separately):
 1. ZS2 Foam Fly Patch
 2. ZS2 Gel Floatant Holder
 3. ZS2 Shimi Shake Floatant Holder
 4. ZS2 Tippet Holder
- Closed-foot zipper sliders (minimize line-snap)
- YKK Zippers
- **Fabric**
 - Body Fabric - 420 Denier Nylon
 - High Wear Locations – Ballistic Nylon



35259 OLIVE

\$43.99 COST
\$79.99 SRP

DIMENSIONS
LENGTH 5 IN.
WIDTH 9 IN
HEIGHT 3.5 IN

CAPACITY
200 CUBIC IN

FLIES

LEADER & TIPPET

PACKS & BAGS

ACCESSORIES

HOOKS

TOOLS & KITS

TYING MATERIALS

NECKS & SADDLES

WADER CHEST PACK



Once you clip this to your wader straps, you will have everything you need at your fingertips. This little chest pack handles two standard fly boxes along with all of the standard ZeroSweep features. One ZeroSweep™ retractor station (great for nipper and floatant attachment), ambidextrous hemostat station, foam fly patch and tippet holder cover all your key accessories. ZS2 version now includes a molle modular attachment station allowing integration with ZS2 accessories.

WADER^{ZS2} CHEST PACK COMPACT CHEST PACK

FEATURES

- 2 x ZS Retractor Stations – with hypalon attachment bands
- 2 x ZS Hemostat Grab Tabs – ambidextrous
- 1 x ZS Foam Fly Patch Station – includes foam fly patch
- 1 x ZS Cord Tippet Holder – “Stowable” when not in use
- 1 x Stretch Mesh Pocket – great for floatant
- Attaches to any belt or rail for instant ZeroSweep work-station
- Integrates seamlessly with ZeroSweep Wader Belt
- 1 x Molle Modular Attachment Station – compatible with the following ZS2 accessories (sold separately):
 1. ZS2 Foam Fly Patch
 2. ZS2 Gel Floatant Holder
 3. ZS2 Shimi Shake Floatant Holder
 4. ZS2 Tippet Holder
- Closed-foot zipper sliders (minimize line-snag)
- YKK Zippers
- Fabric
 - Body Fabric - 420 Denier Nylon
 - High Wear Locations – Ballistic Nylon



35264 OLIVE

\$32.99 COST
\$59.99 SRP

DIMENSIONS
LENGTH 10.5 IN.
WIDTH 3 IN.
HEIGHT 7 IN.



PACKS, BAGS & ORGANIZERS

SLING PACKS

BANDOLIER^{ZS2} SLING AMBIDEXTROUS SLING PACK

FEATURES

- **2 x ZS Retractor Stations** – with hypalon attachment bands
- **2 x ZS Hemostat Grab Tabs** – ambidextrous
- **1 x ZS Foam Fly Patch Station** – includes foam fly patch
- **1 x ZS Cord Tippet Holder** – “Stowable” when not in use
- **1 x Molle Modular Attachment Station** – compatible with the following ZS2 accessories (sold separately):
 - ZS2 Foam Fly Patch
 - ZS2 Gel Floatant Holder
 - ZS2 Shimi Shake Floatant Holder
 - ZS2 Tippet Holder
- **Closed-foot zipper sliders** (minimize line-snag)
- **YKK Zippers**
- **Volume**
300 Cubic Inches (3 Liters)
- **Fabric**
Body Fabric - 420 Denier Nylon
High Wear Locations – Ballistic Nylon

*tools and accessories not included

If you believe in keeping it simple, the Bandolier is a minimalist’s dream-come-true. Comfortably holds two fly boxes in the main compartment and two side pockets conveniently hold accessories. Two ZeroSweep™ retractor stations (great for nipper and floatant attachment), ambidextrous hemostat station, foam fly patch and tippet holder cover all your key accessories. ZS2 version now includes a molle modular attachment station allowing integration with ZS2 accessories.



35251 OLIVE

\$43.99 COST
\$79.99 SRP

DIMENSIONS
LENGTH 18 IN.
WIDTH 3 IN.
HEIGHT 6 IN.

CAPACITY
300 CUBIC IN

SLING PACKS



The Steamboat ZS2 sling carries like a fully-supported backpack leaving your line-of-sight and range-of-motion free up front. Perfect for spey and switch fishermen. A thumb-loop allows for easy “slinging” from back to front for quick access to essentials. A large main compartment easily holds a light rain jacket, lunch and boat box, while a secondary face pocket is great for accessory organization and smaller boxes storage.



STEAMBOAT^{ZS2} 1200 SLING PACK SLING PACK

FEATURES

- 1 x ZS Retractor Stations – with hypalon attachment band
- 2 x ZS Hemostat Grab Tabs – ambidextrous
- 2 x ZS Foam Fly Patch Station – on shoulder & body, includes one foam fly patch
- 1 x ZS Cord Tippet Holder – “Stowable” when not in use
- 1 x Net Slot – runs full length of back panel, great for longer handled nets
- 2 x Stretch Mesh Pockets – on face
- 1 x Vented Back Panel
- 2 x Molle Modular Attachment Station – compatible with the following ZS2 accessories (sold separately):
 - ZS2 Foam Fly Patch
 - ZS2 Gel Floatant Holder
 - ZS2 Shimi Shake Floatant Holder
 - ZS2 Tippet Holder
 - ZS2 Water Bottle Holder
 - ZS2 Water Bottle Holder
- Closed-foot zipper sliders (minimize line-slag)
- YKK Zippers
- Fabric
 - Body Fabric - 420 Denier Nylon
 - High Wear Locations – Ballistic Nylon

35261 OLIVE

\$82.49 COST
\$149.99 SRP

DIMENSIONS
LENGTH 20 IN.
WIDTH 5 IN.
HEIGHT 12 IN.

CAPACITY
1200 CU. IN.



PACKS, BAGS & ORGANIZERS

WADER BELT

Our ZeroSweep™ Wader Belt is the foundation for a completely customizable lumbar fishing system. Beyond a wader belt, this belt provides back support and has a die-cut molle face that allows custom placement/attachment of a wide range of critical accessories. Create your own custom waist pack with the following compatible accessories (sold separately):



WADER BELT^{ZS2}

FEATURES

- Reverse-adjust waist belt for maximum back support & tightening
- Shoulder-strap with floating shoulder pad
- Velcro face for maximum integration/security with accessories
- Compatible with the following ZS2 Molle Accessories and Packs
 - ZS2 Foam Fly Patch
 - ZS2 Gel Floatant Holder
 - ZS2 Shimi Shake Floatant Holder
 - ZS2 Tippet Holder
 - ZS2 Water Bottle Holder
 - ZS2 Net Quiver
 - ZS2 Wader Chest Pack
 - ZS2 Waterproof Wader Chest Pack

35278 OLIVE

\$35.74 COST
\$64.99 SRP

DIMENSIONS
LENGTH 24 IN.
HEIGHT 5IN

FLIES

LEADER & TIPPET

PACKS & BAGS

ACCESSORIES

HOOKS

TOOLS & KITS

TYING MATERIALS

NECKS & SADDLES

WADER BELT

Our ZeroSweep™ Wader Belt is the foundation for a completely customizable lumbar fishing system. Beyond a wader belt, this belt provides back support and has a die-cut molle face that allows custom placement/attachment of a wide range of critical accessories. Create your own custom waist pack with the following compatible accessories (sold separately):



WADER BELT^{ZS2} WITH NET HOLDER

FEATURES

- Reverse-adjust waist belt for maximum back support & tightening
- Shoulder-strap with floating shoulder pad
- Velcro face for maximum integration/security with accessories
- Includes Net Quiver for secure net storage & easy access
- Compatible with the following ZS2 Accessories and Packs

35276 OLIVE

\$54.99 COST
\$99.99 SRP

DIMENSIONS
LENGTH 24 IN.
HEIGHT 5INV

PACKS, BAGS & ORGANIZERS



A completely customizable fishing kit!

Our ZeroSweep™ Wader Belt is the foundation for a completely customizable lumbar fishing system and this kit includes four key accessories. Beyond a wader belt, this belt provides back support and has a die-cut molle face that allows custom placement/attachment of a wide range of critical accessories.



WADER BELT^{ZS2} LOADED

FEATURES

- Reverse-adjust waist belt for maximum back support & tightening
- Shoulder-strap with floating shoulder pad
- Velcro face for maximum integration/security with accessories
- Also integrates with ZS2 Waterproof Wader Chest Pack (not included)
- **Loaded Wader Belt Includes**
 - Net Quiver
 - Gel Floatant Holder
 - Water Bottle Holder
 - Wader Chest Pack
- **Compatible with the following ZS2 Accessories and Packs**
 - ZS2 Foam Fly Patch
 - ZS2 Shimi Shake Floatant Holder
 - ZS2 Tippet Holder
 - ZS2 Waterproof Wader Chest Pack

35279 OLIVE

\$104.49 COST
\$189.99 SRP

DIMENSIONS
LENGTH 24 IN.
HEIGHT 5IN

FLIES

LEADER & TIPPET

PACKS & BAGS

ACCESSORIES

HOOKS

TOOLS & KITS

TYING MATERIALS

NECKS & SADDLES

TRAVELER TYING KIT BAG

The Traveler tying kit bag is the ideal customizable tying kit bag. Our ZS2 molle design allows for internal and external attachment of a vise storage pouch (included). A unique pop-up tool caddy holds up to 22 tools on one side and zippered compartment storage on the other. This tool caddy is removable and free-standing so you feel right at home whether traveling or tying at the kitchen table.

This kit is all about organization and customization thanks to the following:

- External die-cut molle panels on each side for attachment of additional storage
- Pop-up, removable, free-standing tool caddy (14x8x1") Holds up to 22 tools on one side Six zippered mesh pockets on the other
- Thread storage (pop-up caddy holds two, 12" clear thread tubes) for up to 18 spools total
- Two removable, see-through, zippered mesh pockets for hackle and other materials (two-sided = 4 flat storage pockets)
- Internal and external flat pockets for organization
- Vise pouch specifically designed to store multiple vises and pedestal bases (14x9x1")
- Additional pouches (sold separately) can be added/attached for increased storage capacity and storage customization (i.e. saltwater or freshwater)

35238 OLIVE

\$82.49 COST
\$149.99 SRP



FRONT

PACKS, BAGS & ORGANIZERS



35239 OLIVE
\$19.24 COST
\$34.99 SRP

TYING KIT POUCH



35240 OLIVE
\$19.24 COST
\$34.99 SRP

TYING KIT TOOL STATION
TOOLS NOT INCLUDED



35242 OLIVE
\$10.99 COST
\$19.99 SRP

TYING KIT MESH ZIP POUCH



35241
\$3.84 COST
\$6.99 SRP

ZS2 THREAD TUBE

FLIES

LEADER & TIPPET

PACKS & BAGS

ACCESSORIES

HOOKS

TOOLS & KITS

TYING MATERIALS

NECKS & SADDLES

ACCESSORIES

ZS2 FOAM FLY PATCH HOLDER

A great addition to any pack, this accessory holds a ZeroSweep™ fly patch and readily attaches to any loop, D-ring or molle patch in our line. Web loop with “Natick” snap and Velcro back ensures secure attachment to all of our packs. Includes ZeroSweep™ Foam Fly Patch.



35270 OLIVE

\$10.99 COST
\$19.99 SRP

DIMENSIONS
HEIGHT 6.5 IN.
WIDTH 1.75 IN.

ZS2 GEL FLOATANT HOLDER

Holds a wide range of gel floatants and readily attaches to any loop, D-ring or molle patch in our line. Web loop with “Natick” snap ensures secure attachment to all of our packs. Perfect for Tiemco Dry Magic.

*Floatant not included



35272 OLIVE

\$5.49 COST
\$9.99 SRP

DIMENSIONS
HEIGHT 3.5 IN.
WIDTH 1 IN.

ZS2 SHIMI SHAKE FLOATANT HOLDER

If you're not familiar with Tiemco Shimazaki Dry Shake (AKA “Shimi”), then you may not understand how important it is to keep it secure and accessible. Holds a wide range of powder desiccants and readily attaches to any loop, D-ring or molle patch in our line. Web loop with “Natick” snap ensures secure attachment to all of our packs.

*Floatant not included



35274 OLIVE

\$5.49 COST
\$9.99 SRP

DIMENSIONS
HEIGHT 3 IN.
WIDTH 1.5 IN.

ZS2 GEL FLOATANT HOLDER W/ DRY MAGIC

Our ZS2 Gel floatant holder now comes with Tiemco Dry Magic inserted in and ready to apply to your dry flies. Keep your essentials close at hand on our ZS2 molle patch or attach it to any loop or D-ring. Web loop with “Natick” snap ensures secure attachment to all of our packs.



35286 OLIVE

\$14.84 COST
\$26.99 SRP

DIMENSIONS
HEIGHT 3.5 IN.
WIDTH 1 IN.

ZS2 SHIMI SHAKE FLOATANT HOLDER W/ SHIMI

Our ZS2 Dry Shake Holder now comes loaded with the best dry powder on the market Tiemco Shimazaki. Secure it to your ZS2 molle patch, loop, or D-ring on your pack to keep your shake at the ready. Web loop with “Natick” snap ensures secure attachment to all of our packs.



35287 OLIVE

\$13.74 COST
\$24.99 SRP

DIMENSIONS
HEIGHT 3 IN.
WIDTH 1.5 IN.

PACKS, BAGS & ORGANIZERS

ZS2 TIPPET HOLDER

- Keep your tippet at your finger-tips
- A great addition to any pack, this tippet holder readily holds 6 standard tippet spools and securely attaches to any loop, D-ring or molle patch in our line. Web loop with “Natick” snap with Velcro back ensures secure attachment to all of our packs.
- Aluminum post for free spool rotation
- Rubber retainers keep your tippet securely in place
- Clip-cord attachment allows easy spool changes and replacement

*Tippet not included



35275 OLIVE

\$10.99 COST
\$19.99 SRP

DIMENSIONS
HEIGHT 3.5 IN.
WIDTH 1 IN.

ZS2 WATERBOTTLE HOLDER

Will securely hold a wide range of water bottles and readily attach to many of our packs. Reinforced web loops with “Natick” snaps and web loops ensure secure attachment. Design allows for easy, one-hand access with adjustable, elastic security strap. Integrates seamlessly with the following packs:

- a. Wader BeltZS2
- b. Ledges ZS2 500 & 650 Waist Packs
- c. Steamboat ZS2 Sling
- d. Overlook ZS2 Chest Pack (to pack back)

*Bottle not included



35277 OLIVE

\$13.74 COST
\$24.99 SRP

DIMENSIONS
HEIGHT 7 IN.
WIDTH 4 IN.

ZS2 NET QUIVER

A perfect addition to our Wader BeltZS2, it just as easily attaches to both our LedgesZS2 500 and 650. Reinforced web loops with “Natick” snaps and web loops ensure secure attachment to any belt. Well-padded holster with ballistic nylon fabric for long-term durability.



35273 OLIVE

\$21.99 COST
\$39.99 SRP

DIMENSIONS
LENGTH 5 IN.
WIDTH 3 IN.
HEIGHT 7 IN.

ZS2 WATERPROOF

Keep your valuables dry and organized in this perfect balance of external functionality and internal protection. Highly structured lid supports ZS2 Fly Patch and hemostat station for easy access. YKK weather-proof zipper and internal elevated rim keeps your contents dry in the worst of squalls & splash. Perfect, snag-free design and size for moving in and out of boat deck storage.

BOAT BAG^{ZS2} MEDIUM

FEATURES

- Clear and mesh flat zippered pockets on lid underside
- Structured lid and dry-lock rim result in natural weatherproof protection even when not zipped
- ZS2 Fly Patch Station (fly patch included)
- Hypalon hemostat attachment station
- Internal dividers for easy organization
- Removable shoulder strap
- Holds up to four Bug Locker 3618s/LT Payloads/Plano 3600s
- YKK weather-proof zipper



35282 GRAY

\$120.99 COST
\$219.99 SRP

DIMENSIONS
LENGTH 13 IN.
WIDTH 9 IN.
HEIGHT 9.5 IN

PACKS, BAGS & ORGANIZERS

When you enter the land of waterproof packs, you usually enter a land of great compromise. A few welded compartments with very few additional features, if any, and very difficult access (zippers that require training and conditioning to open and close). With our new line of ZS2 waterproof packs, we have focused on access and usability. By using different closures for different purposes (zippers and roll-tops where appropriate) we believe we have created a system that can be made to work for any flyfisher's needs.

FLIES

LEADER & TIPPET

PACKS & BAGS

ACCESSORIES

HOOKS

TOOLS & KITS

TYING MATERIALS

NECKS & SADDLES



UPG FLY BOXES

Meet the next evolution of premium fly boxes.

UPG LT (LIGHT) and UPG HD (HEAVY DUTY)... Our entirely evolved line of UPG fly boxes gives any angler multiple features, options and configurations through their flexible designs.

257

FLIES

LEADER & TIPPET

PACKS & BAGS

ACCESSORIES

HOOKS

TOOLS & KITS

TYING MATERIALS

NECKS & SADDLES

UPG DIFFERENCE



Loaded Dual Essential
by Signature Tyer Lance Egan

UPG FLY BOXES

UPG FOAM BOXES

FLIES

LEADER & TIPPET

PACKS & BAGS

ACCESSORIES

HOOKS

TOOLS & KITS

TYING MATERIALS

NECKS & SADDLES

NEW**ESSENTIAL- FOAM****\$13.74****DIMENSIONS: 7.25" X 4" X 0.9"**

COLOR	INSERT CONFIGURATION	CODE	SRP
GRAY	STANDARD	30055	\$24.99
HOT ORANGE	STANDARD	30057	\$24.99

An extremely versatile, high-capacity slim box perfect for an extensive range of dries & nymphs. We called it the Essential Fly Box for a reason, every angler needs one. This box can do it all and anglers can build it anyway they like. Add a little bit of everything - dries, nymphs, buggers and head out to the water.

NEW**DUAL ESSENTIAL- FOAM****\$19.24****DIMENSIONS: 7.25" X 4" X 0.9"**

COLOR	INSERT CONFIGURATION	CODE	SRP
GRAY	STANDARD/ STANDARD	30088	\$34.99

A double-sided version of our ever-popular Essential model, this large, slim foam box will help you maximize capacity of your standard nymphs and dry flies. For anglers who want to have every variation of every size of their favorite flies the Dual Essential Large Fly Box offers maximum organization and maximum capacity. A workhorse of a fly box in a slim package that securely holds all your favorite dries and nymphs from sz 22-8.

NEW**ESSENTIAL MINI- FOAM****\$10.99****DIMENSIONS: 5.5" X 3.4" X 0.9"**

COLOR	INSERT CONFIGURATION	CODE	SRP
GRAY	MINI STANDARD	30056	\$19.99
HOT ORANGE	MINI STANDARD	30058	\$19.99

An extremely versatile, compact slim box perfect for an extensive range of dries & nymphs. Sneak out for some pre or post work fishing with the Essential Mini Fly Box. This pocket-sized box can hold all the flies you need to carry to stay organized and make the most of any time on the water.

NEW**DUAL ESSENTIAL MINI- FOAM****\$16.49****DIMENSIONS: 5.5" X 3.4" X 0.9"**

COLOR	INSERT CONFIGURATION	CODE	SRP
GRAY	MINI STANDARD/ MINI STANDARD	30089	\$29.99

A double-sided version of our ever-popular Essential model, this miniature, slim foam box will help you maximize capacity of your standard nymphs and dry flies in a smaller-than-average package. The pocket sized Dual Essential Mini Fly Box is a fantastic box for organizing a wide variety of flies for local trips or journeys deep into the backcountry.

NEW**DAYTRIPPER- FOAM****\$16.49****DIMENSIONS: 7.25" X 4" X 0.9"**

COLOR	INSERT CONFIGURATION	CODE	SRP
RED	HYBRID	30052	\$29.99

A versatile mix of foam and magnetic fly storage in a thin box fit for a range of dries, nymphs, and even small streamers. The Daytripper Large Fly Box holds a day's worth of flies for any scenario the river can throw at you. The unique mix of fly storage options makes this a great box for everyday use.

NEW**DAYTRIPPER MINI- FOAM****\$13.74****DIMENSIONS: 5.5" X 3.4" X 0.9"**

COLOR	INSERT CONFIGURATION	CODE	SRP
RED	MINI HYBRID	30053	\$24.99

This compact and slim box features micro-slit foam and a large magnetic surface for storing and organizing all your smallest bugs with ease. Designed for the adventure seeker who needs to keep their must have flies at the ready or in their pocket, The Daytripper Mini Fly Box is an angler's best friend.

UPG FOAM BOXES



WEEKENDER-FOAM

\$19.24

DIMENSIONS: 7.25" X 4" X 1"

COLOR	INSERT CONFIGURATION	CODE	SRP
OLIVE	STANDARD/ HYBRID	30069	\$34.99

A double-sided slim box with a mix of foam and magnetic fly storage perfect for many different dries, nymphs, and even small streamers. If you had to have one box that would keep you organized and ready for anything from sun up to sun down, we would choose the Weekender Fly Box. With tons of capacity and a variety of storage options this box is as diverse as the flies you loaded up on in preparation for the big trip.



WEEKENDER MINI-FOAM

\$16.49

DIMENSIONS: 5.5" X 3.4" X 0.9"

COLOR	INSERT CONFIGURATION	CODE	SRP
OLIVE	MINI STANDARD/ MINI HYBRID	30070	\$29.99

A double-sided slim compact box with a variety of slit foam and magnetic storage options to hold all your standard and micro bugs. When a day of fishing isn't enough, but you don't have all weekend, the Weekender Mini Fly Box is just the right size. It is just right for any fishing adventure or whatever fly organization needs you have.



STREAMER-FOAM

\$16.49

DIMENSIONS: 7.25" X 4" X 1"

COLOR	INSERT CONFIGURATION	CODE	SRP
OLIVE	MEGA SLIT	30067	\$29.99

A slim, single-sided box with Mega-Slit Foam perfect for when you need to take a selection of larger streamers on the go. Long, deep slits make for easy storage of articulated flies in a smaller box. For the streamer junkie who likes deep missions where other anglers don't go, pack in the Streamer Fly Box for all your large fly needs.



SALT BAITFISH-FOAM

\$13.74

DIMENSIONS: 7.25" X 4" X 1"

COLOR	INSERT CONFIGURATION	CODE	SRP
AQUA	MEGA SLIT	30051	\$24.99

A slim, single-sided box with Mega-Slit Foam capable of handling all your saltwater baitfish and large fly storage needs. The Baitfish Fly Box is the perfect box for chasing saltwater fish from flatwings for Strippers to toads for Tarpon, the see through lids make staying organized a breeze.



SALT FLATS-FOAM

\$13.74

DIMENSIONS: 7.25" X 4" X 1"

COLOR	INSERT CONFIGURATION	CODE	SRP
AQUA	FLATS	30063	\$24.99

Slim foam fly storage built for a variety of saltwater flats and larger freshwater flies with a variable insert design. The Flats Fly Box is the perfect option for holding a variety of shrimp and crab flies for Bonefish, Permit, or whatever large flies you need to organize.



MAGNETO-FOAM

\$16.49

DIMENSIONS: 7.25" X 4" X 0.75"

COLOR	INSERT CONFIGURATION	CODE	SRP
RED	MAGNETO	30065	\$29.99

A slim fly box with strong magnets great for small to tiny fly storage. Foam rims surrounding 6 separate magnetic compartments give you a place to stick go-to bugs for quick access. There is no better option for all those small flies than the Magneto, just ask tailwater junkie Pat Dorsey.

UPG FLY BOXES

NEW



MAGNETO MINI- FOAM

\$13.74

DIMENSIONS: 5.5" X 3.4" X 0.75"

COLOR	INSERT CONFIGURATION	CODE	SRP
RED	MAGNETO	30066	\$24.99

A slim and compact fly box with strong magnets great for small fly or hook storage. Foam rims surrounding 3 separate magnetic compartments give you a place to stick go-to bugs for quick access. The Magneto Mini is the perfect tailwater small fly box for cold fingers and hot fishing.

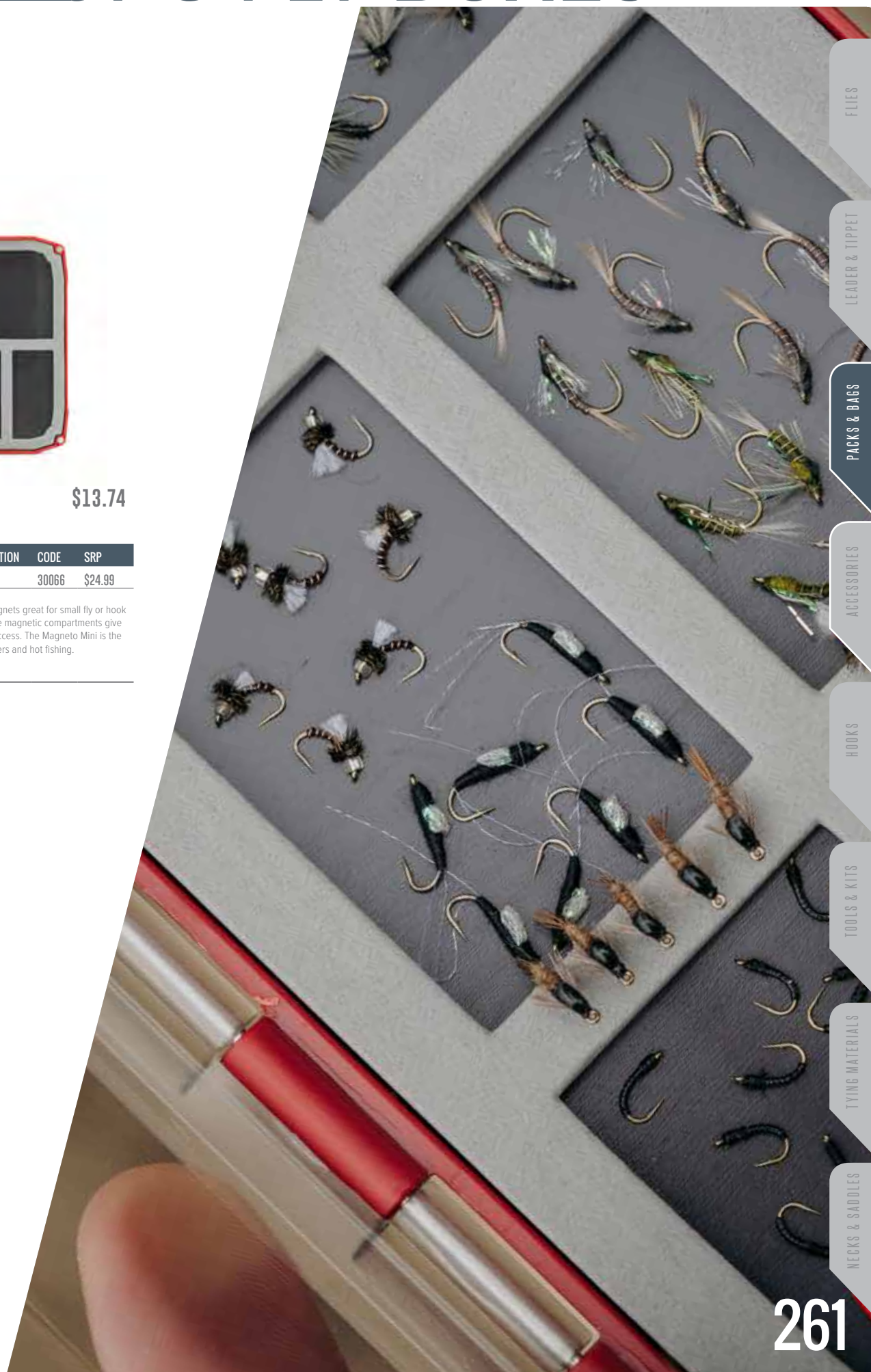

FLIES

LEADER & TIPPET

PACKS & BAGS

ACCESSORIES

HOOKS

TOOLS & KITS

TYING MATERIALS

NECKS & SADDLES

UPG WP FOAM



ESSENTIAL WATERPROOF- FOAM \$21.99

DIMENSIONS: 7.75"x4.5"x1.6"

COLOR	INSERT CONFIGURATION	CODE	SRP
GRAY	STANDARD/ STANDARD	30059	\$39.99
HOT ORANGE	STANDARD/ STANDARD	30061	\$39.99

An extremely versatile, high-capacity waterproof box perfect for an extensive range of dries & nymphs. The Waterproof Essential Large is a wonderful fly box that has a see-through lid for easy ID of your selection of flies. The FlyTrap insert allows for great storage of both fully hackled dries or rows of nymphs.



ESSENTIAL WATERPROOF MEDIUM- FOAM \$19.24

DIMENSIONS: 6.25"x4.5"x1"

COLOR	INSERT CONFIGURATION	CODE	SRP
GRAY	MED STANDARD/ MED STANDARD	30060	\$34.99
HOT ORANGE	MED STANDARD/ MED STANDARD	30062	\$34.99

An extremely versatile, medium-sized waterproof box perfect for an extensive range of dries & nymphs. The Waterproof Essential Medium Fly Box is the perfect box for summer wet wading or securely holding and organizing your flies for waters local or abroad.



DAYDRIPPER WATERPROOF- MEDIUM FOAM \$19.24

DIMENSIONS: 6.25"x4.5"x1"

COLOR	INSERT CONFIGURATION	CODE	SRP
RED	MED HYBRID/ MED STANDARD	30054	\$34.99

This box will hold all your standard and micro bugs in a variety of slit foam and magnetic storage options. The Waterproof Dayripper Medium Fly Box is built to organize your flies for a great day on the water. Perfect for building out hatch specific boxes or for anglers looking to bring the bugs they need for their favorite waters.



WEEKENDER WATERPROOF- FOAM \$24.74

DIMENSIONS: 7.75"x4.5"x1.6"

COLOR	INSERT CONFIGURATION	CODE	SRP
OLIVE	HYBRID/ STANDARD	30071	\$44.99

A versatile mix of foam and magnetic fly storage fit for a range of dries, nymphs, and even small streamers. The Waterproof Weekender Large is a great box for anglers who are looking for a super versatile box. From small flies to large streamers the Weekender keeps your flies organized and protected for wherever your adventure takes you.

UPG FLY BOXES

NEW



WALKABOUT WATERPROOF- FOAM \$30.24

DIMENSIONS: 7.75"x4.5"x1.6"

COLOR	INSERT CONFIGURATION	CODE	SRP
OLIVE	STANDARD/ STANDARD STANDARD/ HYBRID	30068	\$54.99

The perfect solution for when you need to fit your whole arsenal in a single box. Two swing leaves hold four foam/magnetic inserts to ensure you are prepared for every situation. The Waterproof Walkabout Fly Box allows you to organize all your flies for full days chasing hatches on the water. Bring 1,000 of your favorite flies with you in this high-capacity fly box.

NEW



SALT FLATS WATERPROOF- FOAM \$19.24

DIMENSIONS: 6.25"x4.5"x1"

COLOR	INSERT CONFIGURATION	CODE	SRP
AQUA	FLATS/ MEGA SLIT	30064	\$34.99

Our most secure saltwater fly box that features two different foam insert configurations for the unique storage needs that saltwater flies require. This fly box is completely waterproof to prevent flies from corrosion and the harsh environments that the flats offer.

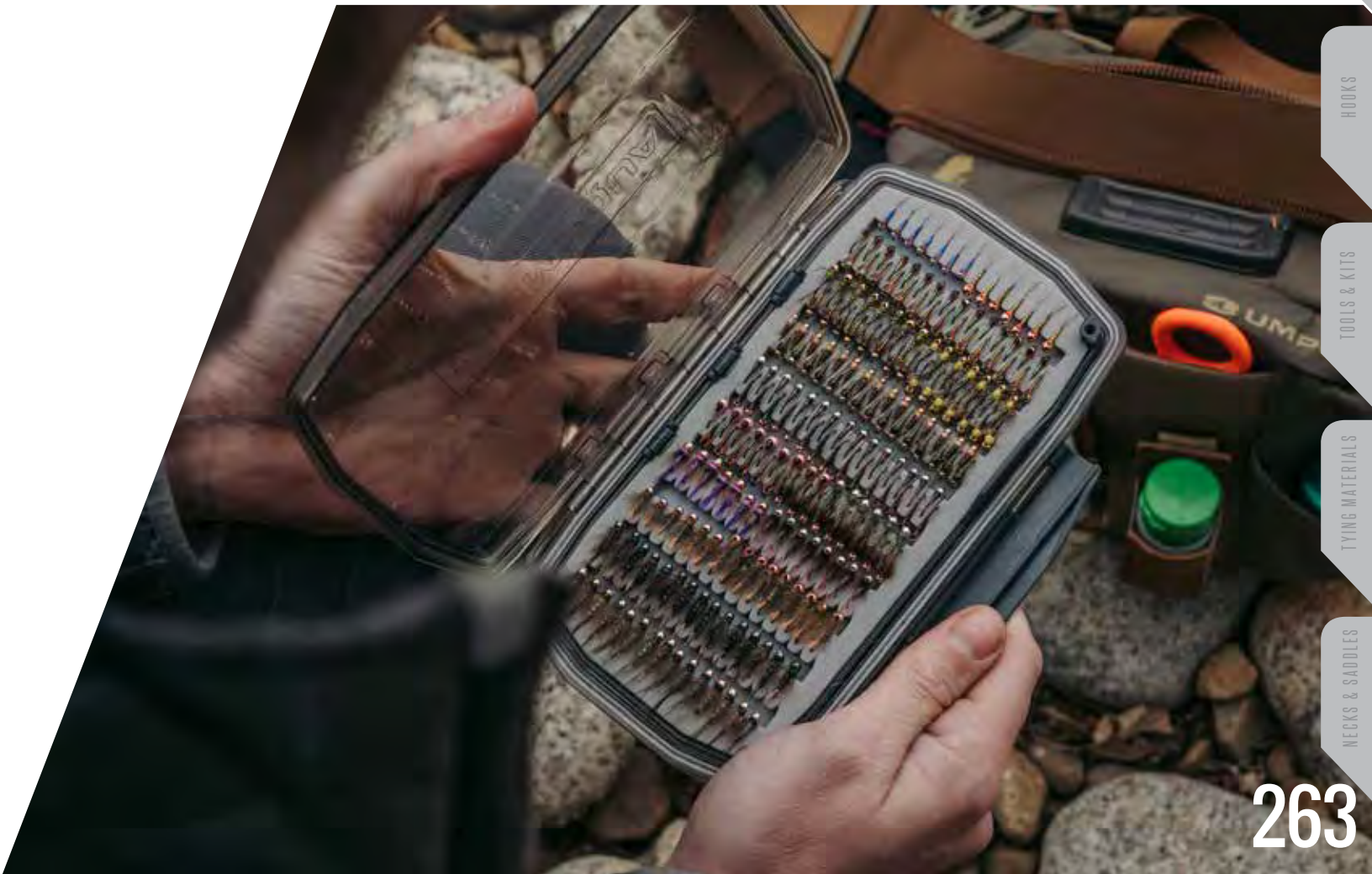

FLIES

LEADER & TIPPET

PACKS & BAGS

ACCESSORIES

HOOKS

TOOLS & KITS

TYING MATERIALS

NECKS & SADDLES

UPG SILICONE

NEW



ESSENTIAL- SILICONE

\$13.74

DIMENSIONS: 7.25" X 4" X 0.9"

COLOR	INSERT CONFIGURATION	CODE	SRP
BLUE	STANDARD	30075	\$24.99
HOT GREEN	STANDARD	30077	\$24.99

An extremely versatile, high-capacity slim box perfect for an extensive range of dries & nymphs. We called it the Essential Fly Box for a reason, every angler needs one. This box can do it all and anglers can build it anyway they like. Add a little bit of everything - dries, nymphs, buggers and head out to the water.

NEW



DUAL ESSENTIAL- SILICONE

\$19.24

DIMENSIONS: 7.25" X 4" X 0.9"

COLOR	INSERT CONFIGURATION	CODE	SRP
BLUE	STANDARD/ STANDARD	30090	\$34.99

A double-sided version of our ever-popular Essential model, this large, slim silicone box will help you maximize capacity of your standard nymphs and dry flies. For anglers who want to have every variation of every size of their favorite flies the Dual Essential Large Fly Box offers maximum organization and maximum capacity. A workhorse of a fly box in a slim package that securely holds all your favorite dries and nymphs from sz 22-8.

NEW



ESSENTIAL MINI- SILICONE

\$10.99

DIMENSIONS: 5.5" X 3.4" X 0.9"

COLOR	INSERT CONFIGURATION	CODE	SRP
BLUE	MINI STANDARD	30076	\$19.99
HOT GREEN	MINI STANDARD	30078	\$19.99

An extremely versatile, compact slim box perfect for an extensive range of dries & nymphs. Head out for some pre or post work fishing with the Essential Mini Fly Box. This pocket-sized box can hold all the flies you need to carry to stay organized and make the most of any time on the water.

NEW



DUAL ESSENTIAL MINI- SILICONE

\$16.49

DIMENSIONS: 5.5" X 3.4" X 0.9"

COLOR	INSERT CONFIGURATION	CODE	SRP
BLUE	MINI STANDARD/ MINI STANDARD	30091	\$29.99

A double-sided version of our ever-popular Essential model, this miniature, slim silicone box will help you maximize capacity of your standard nymphs and dry flies in a smaller-than-average package. The pocket sized Dual Essential Mini Fly Box is a fantastic box for organizing a wide variety of flies for local trips or journeys deep into the backcountry.

NEW



DAYTRIPPER- SILICONE

\$16.49

DIMENSIONS: 7.25" X 4" X 0.9"

COLOR	INSERT CONFIGURATION	CODE	SRP
LIME	HYBRID	30072	\$29.99

A versatile mix of silicone and magnetic fly storage in a thin box fit for a range of dries, nymphs, and even small streamers. The Daytripper Large Fly Box holds a day's worth of flies for any scenario the river can throw at you. The unique mix of fly storage options makes this a great box for everyday use.

NEW



DAYTRIPPER MINI- SILICONE

\$13.74

DIMENSIONS: 5.5" X 3.4" X 0.9"

COLOR	INSERT CONFIGURATION	CODE	SRP
LIME	MINI HYBRID	30073	\$24.99

This compact and slim box features min-slit silicone and a large magnetic surface for storing and organizing all your smallest bugs with ease. Designed for the adventure seeker who need to keep their must have flies at the ready or in their pocket, The Daytripper Mini Fly Box is an angler's best friend.

UPG FLY BOXES

NEW



WEEKENDER- SILICONE \$19.24

DIMENSIONS: 7.25" X 4" X 1"

COLOR	INSERT CONFIGURATION	CODE	SRP
CLARET	STANDARD/ HYBRID	30085	\$34.99

A versatile mix of silicone and magnetic fly storage fit for a range of dries, nymphs, and even small streamers. If you had to have one box that would keep you organized and ready for anything from sun up to sun down, we would choose the Weekender Fly Box. With tons of capacity and a variety of storage options this box is as diverse as the flies you loaded up on in preparation for the big trip.

NEW



WEEKENDER MINI- SILICONE \$16.49

DIMENSIONS: 5.5" X 3.4" X 0.9"

COLOR	INSERT CONFIGURATION	CODE	SRP
OLIVE	MINI STANDARD/ MINI HYBRID	30086	\$29.99

A double-sided slim compact box with a variety of slit silicone and magnetic storage options to hold all your standard and micro bugs. When a day of fishing isn't enough, but you don't have all weekend, the Weekender Mini Fly Box is just the right size. It is just right for any fishing adventure or whatever fly organization needs you have.

NEW



STREAMER- SILICONE \$16.49

DIMENSIONS: 7.25" X 4" X 1"

COLOR	INSERT CONFIGURATION	CODE	SRP
LIME	MEGA SLIT	30083	\$29.99

A slim, single-sided box with Mega-Slit Silicone perfect for when you need to take a selection of larger streamers on the go. Long, deep slits make for easy storage of articulated flies in a smaller box. For the streamer junkie who likes deep missions where other anglers don't go, pack in the Streamer Fly Box for all your large fly needs.

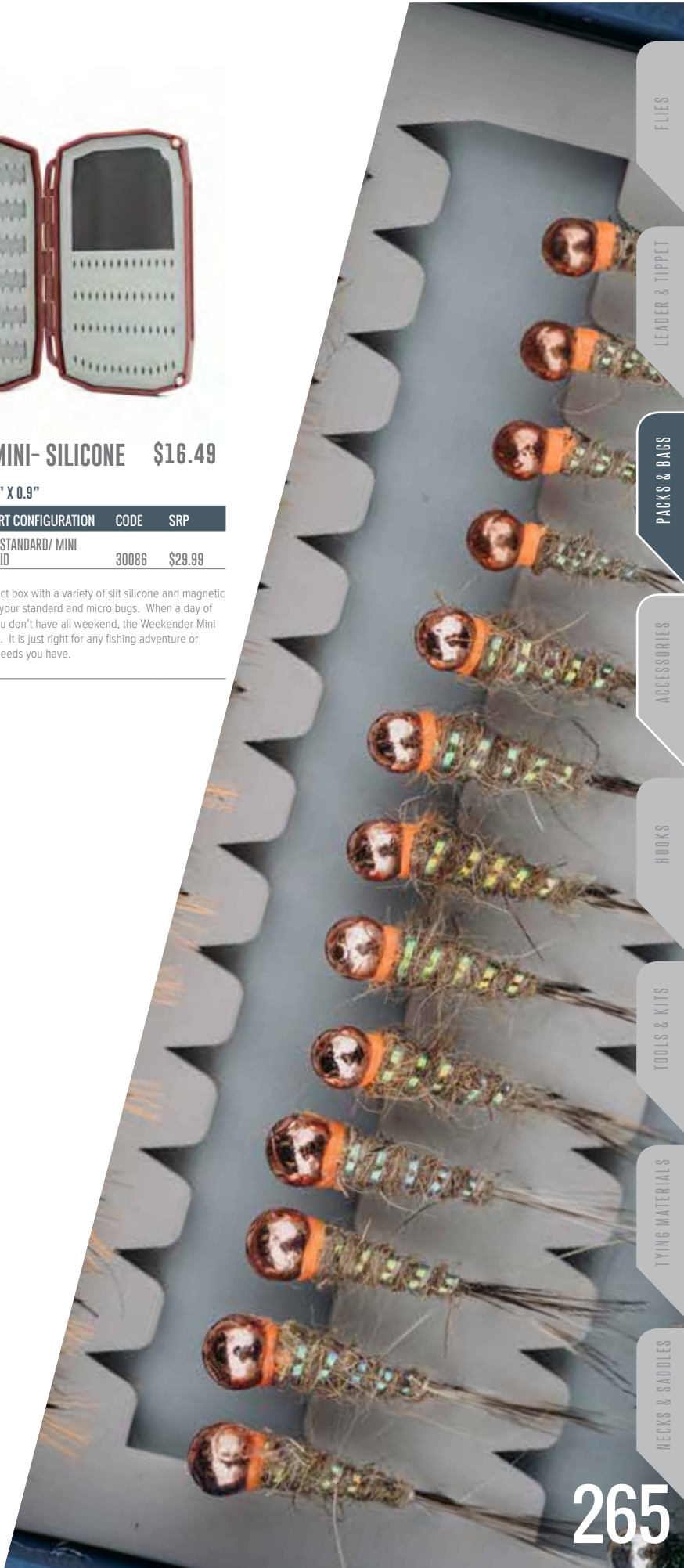

FLIES

LEADER & TIPPET

PACKS & BAGS

ACCESSORIES

HOOKS

TOOLS & KITS

TYING MATERIALS

NECKS & SADDLES

UPG WP SILICONE

NEW



ESSENTIAL WATERPROOF- SILICONE \$21.99

DIMENSIONS: 7.75"x4.5"x1.6"

COLOR	INSERT CONFIGURATION	CODE	SRP
BLUE	STANDARD/ STANDARD	30079	\$39.99
HOT GREEN	STANDARD/ STANDARD	30081	\$39.99

An extremely versatile, high-capacity waterproof box perfect for an extensive range of dries & nymphs. The Waterproof Essential Large is wonderful fly box that has a see-through lid for easy ID of your selection of flies. The FlyTrap insert allows for great storage of both fully hackled dries or rows of nymphs.

NEW



ESSENTIAL WATERPROOF MEDIUM- SILICONE \$19.24

DIMENSIONS: 6.25"x4.5"x1"

COLOR	INSERT CONFIGURATION	CODE	SRP
BLUE	MED STANDARD/ MED STANDARD	30080	\$34.99
HOT GREEN	MED STANDARD/ MED STANDARD	30082	\$34.99

An extremely versatile, medium-sized waterproof box perfect for an extensive range of dries & nymphs. The Waterproof Essential Medium Fly Box is the perfect box for summer wet wading or securely holding and organizing your flies for waters local or abroad.

NEW



DAYDRIPPER WATERPROOF-MEDIUM SILICONE \$19.24

DIMENSIONS: 6.25"x4.5"x1"

COLOR	INSERT CONFIGURATION	CODE	SRP
LIME	MED HYBRID/ MED STANDARD	30074	\$34.99

This box will hold all of your standard and micro bugs in a variety of slit silicone and magnetic storage options. The Waterproof Dayripper Medium Fly Box is built to organize the flies for a great day on the water. Perfect for building out hatch specific boxes or for anglers looking to bring the bugs they need for their favorite waters.

NEW



WEEKENDER WATERPROOF- SILICONE \$24.74

DIMENSIONS: 7.75"x4.5"x1.6"

COLOR	INSERT CONFIGURATION	CODE	SRP
CLARET	HYBRID/ STANDARD	30087	\$44.99

A versatile mix of silicone and magnetic fly storage fit for a range of dries, nymphs, and even small streamers. The Waterproof Weekender Large is a great box for anglers who are looking for a super versatile box. From small flies to large streamers the Weekender keeps your flies organized and protected for wherever your adventure takes you.

UPG FLY BOXES

NEW



WALKABOUT WATERPROOF- SILICONE \$30.24

DIMENSIONS: 7.75"x4.5"x1.6"

COLOR	INSERT CONFIGURATION	CODE	SRP
CLARET	STANDARD/ STANDARD STANDARD/ HYBRID	30084	\$54.99

The perfect solution for when you need to fit your whole arsenal in a single box. Two swing leaves hold four silicone/magnetic inserts to ensure you are prepared for every situation. The Waterproof Walkabout Fly Box allows you to organize all your flies for full days chasing hatches on the water. Bring 1,000 of your favorite flies with you in this high-capacity fly box.

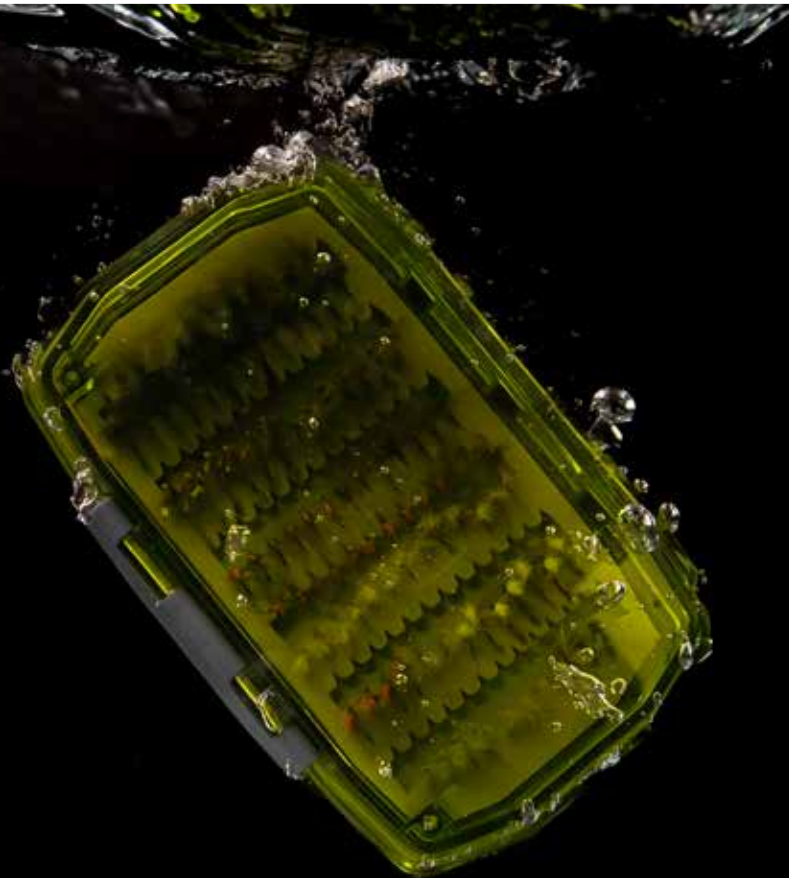

FLIES

LEADER & TIPPET

PACKS & BAGS

ACCESSORIES

HOOKS

TOOLS & KITS

TYING MATERIALS

NECKS & SADDLES

PAYLOAD BOXES



UPG LT PAYLOAD BOAT BOX SALT

A serious box for serious fly storage. This high capacity box will easily hold the largest baitfish down to your smallest flats flies with a “high” side and a “standard” side to offer appropriate headroom for any saltwater fly-fishing adventure. See-through lids allow for easy fly ID and magnetic lid and swing leaf closures offer easy access.

DIMENSIONS: 12” X 7” X 2.25”

COLOR	CODE	INSERT CONFIGURATIONS	COST	SRP
AQUA	30858	MEGASLIT FOAM	\$32.99	\$59.99



UPG LT PAYLOAD BOAT BOX FRESHWATER

Serious anglers now have serious storage. This high capacity box will easily hold your largest streamers and bass bugs down to any standard dries & nymphs with a “high” side and a “standard” side to offer appropriate headroom for any fly-fishing adventure. See-through lids allow for easy fly ID and magnetic lid and swing leaf closures offer easy access.

DIMENSIONS: 12” X 7” X 2.25”

COLOR	CODE	INSERT CONFIGURATIONS	COST	SRP
OLIVE	30859	MEGASLIT/ HYBRID FOAM	\$32.99	\$59.99

UPG FLY BOXES



FLIES

LEADER & TIPPET

PACKS & BAGS

ACCESSORIES

HOOKS

TOOLS & KITS

TYING MATERIALS

NECKS & SADDLES

BUG LOCKERS



LARGE

Our most versatile box will carry a wide range of dries and nymphs with our 3-D molded high-grip FlyTrap™ storage system.

DIMENSIONS: 14.0" X 8.5" X 2.0"

COLOR	CODE	COMPARTMENTS	COST	SRP
AQUA	33130	17	\$13.74	\$24.99
OLIVE	33131	17	\$13.74	\$24.99



MEDIUM

Our most versatile box will carry a wide range of dries and nymphs with our 3-D molded high-grip FlyTrap™ storage system.

DIMENSIONS: 10.5" X 7.0" X 1.75"

COLOR	CODE	COMPARTMENTS	COST	SRP
AQUA	33132	20	\$10.99	\$19.99
OLIVE	33133	20	\$10.99	\$19.99

FLY BOXES



BUG LOCKERS

ADJUSTABLE COMPARTMENTS

BUG LOCKER 4624

\$8.24 EACH



COLOR	DIMENSIONS	COMPARTMENTS	CODE	SRP
BLUE	14 x 8 3/4 x 1 7/8"	24	33095	\$14.99
GRAY			33096	
OLIVE			33097	

Lightweight, see-through and configurable. Insertable dividers (included) allow for maximum customization up to 24 compartments. Perfect for saltwater and larger freshwater fly storage.

BUG LOCKER 3618

\$6.59 EACH



COLOR	DIMENSIONS	COMPARTMENTS	CODE	SRP
BLUE	10 3/4 x 4 3/8 x 1 3/4"	18	33098	\$11.99
GRAY			33099	
OLIVE			33100	

Lightweight, see-through and configurable. Insertable dividers (included) allow for maximum customization up to 18 compartments. Perfect for saltwater and larger freshwater fly storage.

BUG LOCKER 3618 SM

\$5.49 EACH



COLOR	DIMENSIONS	COMPARTMENTS	CODE	SRP
BLUE	9 1/8 x 4 3/4 x 1 1/4"	18	33104	\$9.99
GRAY			33105	
OLIVE			33106	

Lightweight, see-through and configurable. Insertable dividers (included) allow for maximum customization up to 18 compartments. Perfect for varied mix of dries, nymphs and streamers.

BUG LOCKER 3412

\$5.49 EACH



COLOR	DIMENSIONS	COMPARTMENTS	CODE	SRP
BLUE	6 7/8 x 5 1/2 x 1 3/4"	12	33101	\$9.99
GRAY			33102	
OLIVE			33103	

Lightweight, see-through and configurable. Insertable dividers (included) allow for maximum customization up to 12 compartments. Perfect for saltwater and larger freshwater fly storage.

FIXED COMPARTMENTS

BUG LOCKER 169V

\$4.39 EACH



COLOR	DIMENSIONS	COMPARTMENTS	CODE	SRP
GRAY	6 3/4 x 3 3/4 x 1 1/4"	9	33107	\$7.99

Lightweight and see-through. An excellent combination of four longer compartments for streamers and 5 smaller compartments for dries/nymphs.

BUG LOCKER 259

\$3.29 EACH



COLOR	DIMENSIONS	COMPARTMENTS	CODE	SRP
OLIVE	6 x 3 1/4 x 1 1/4"	9	33108	\$5.99

Lightweight and see-through. A great combination of eight standard compartments and one longer compartment for bigger bugs.

FLY BOXES

BUG LOCKER 236

\$2.74 EACH



COLOR	DIMENSIONS	COMPARTMENTS	CODE	SRP
BLUE	4 3/4 x 3 x 1"	6	33110	\$4.99

Lightweight and see-through. Six medium compartments make this a great box for your go-to dry flies and nymphs.

BUG LOCKER 236 POP TOP

\$2.74 EACH



COLOR	DIMENSIONS	COMPARTMENTS	CODE	SRP
OLIVE	3 1/2 x 2 1/2 x 5/8"	6	33112	\$4.99

Lightweight and see-through. A perfect pocket-sized box for small dries & nymphs or hook & bead storage. Lids open independently.

BUG LOCKER 236 MINI

\$2.74 EACH



COLOR	DIMENSIONS	COMPARTMENTS	CODE	SRP
GRAY	3 1/2 x 2 1/2 x 3/4"	6	33113	\$4.99

Lightweight and see-through. A perfect pocket-sized box for small dries and nymphs.



FLIES

LEADER & TIPPET

PACKS & BAGS

ACCESSORIES

HOOKS

TOOLS & KITS

TYING MATERIALS

NECKS & SADDLES

BOAT BOXES

The Umpqua Magnum Boat Box, Ultimate Boat Box and Baby Boat Box offer the perfect solution for big fly storage. Each box features slotted foam internally on the top and bottom lid, and unlike other boxes on the market, one external slotted foam sheet for easy drying, organizing or quick access while behind the oars. The thick durable foam features fly placement guides to easily identify where the slots are located.

MAGNUM BOAT BOX



16.5" x 12.5" x 3.5"

CODE	COLOR	COST	SRP
30865	BLACK	\$41.24	\$74.99
30819	SAGE		



EXTERIOR FOAM

BOAT BOXES FEATURE UNIQUE EXTERIOR FOAM FOR QUICK FLY ACCESS.

ULTIMATE BOAT BOX



14" x 10.5" x 3.25"

CODE	COLOR	COST	SRP
30861	BLACK	\$32.99	\$59.99
30815	SAGE		



FOAM SHEET



BABY BOAT BOX



10" x 8.25" x 3"

CODE	COLOR	COST	SRP
30860	BLACK	\$24.72	\$44.99
30811	SAGE		

SIZE	CODE	COST	SRP
BABY	30862	\$6.59	\$11.99
ULTIMATE	30863	\$8.24	\$14.99
MAGNUM	30864	\$10.99	\$19.99

FLY BOXES

MYRAN FLY BOXES AND ORGANIZERS

Made from non-brittle, sturdy ABS clear plastic and boast the original brass-embedded fly box hinge. Snaps close easily and securely yet opens with ease.

Note: 2/3 means two compartments deep by three compartments long, for a total of six compartments.

TMC SMALL STREAMER BOX

\$4.94 EACH



COLOR	SIZE	CODE	SRP
SMOKE	4 3/4 x 3 x 1	30727	\$8.99

UMPQUA™ HOOK BOX

\$7.69 EACH



SIZE	CODE	SRP
	30697	\$13.99

This Umpqua™ hook box features 21 individual hook compartments with size legend. Snaps tight for easy travel and storage.

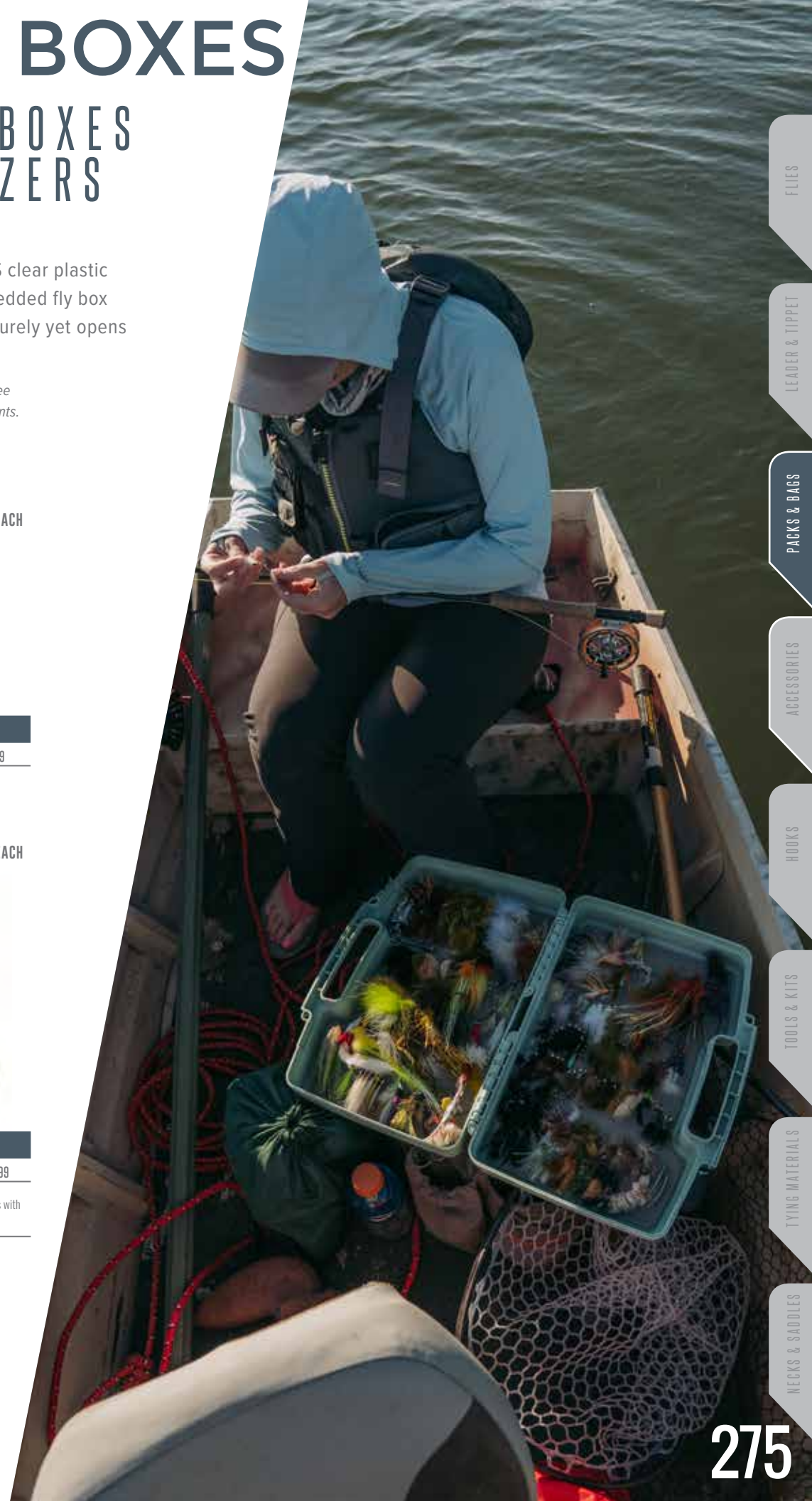

FLIES

LEADER & TIPPET

PACKS & BAGS

ACCESSORIES

HOOKS

TOOLS & KITS

TYING MATERIALS

NECKS & SADDLES



STREAMSIDE ACCESSORIES

In addition to making the world's most dependable and high-quality flies, Umpqua also carries an impressive line of angling accessories. From floatants to hemostats, we are confident that the products on the following pages will help any angler improve their game.

FLIES

LEADER & TIPPET

PACKS & BAGS

ACCESSORIES

HOOKS

TOOLS & KITS

TYING MATERIALS

NECKS & SADDLES

277

FLOATANTS

**TIEMCO™
SHIMAZAKI™
DRY SHAKE
ORIGINAL**

\$82.40/10



ITEM	CODE	COST	SRP
EACH	30253	\$8.24	\$14.99 EA
10-PACK	30252	\$82.40	\$14.99 EA

Great for drying and reconditioning flies. When your dry fly begins to sink, just put it in the dry shake container and shake it. The absorbing powder in the bottle removes the moisture from the fly and coats it with a water resistant material. Your fly will again float like new.

**TIEMCO™
SHIMAZAKI™
DRY SHAKE
LIQUID**

\$137.40/10



ITEM	CODE	COST	SRP
EACH	30257	\$13.74	\$24.99 EA
10-PACK	30272	\$137.40	\$24.99 EA

The liquid version of the Shimazaki Dry Shake. This new Liquid floatant with "Dry Shake" powder offers an easier and more effective application.

**TIEMCO
SHIMAZAKI™
DRY SHAKE
SPRAY
1.69 FL OZ CAN**

\$181.40/10



ITEM	CODE	COST	SRP
EACH	30256	\$18.14	\$32.99 EA
10-PACK	30271	\$181.40	\$32.99 EA

Experience that amazing Shimazaki buoyancy from an easy application, LPG spray. Just one quick spritz will keep your fly floating just like the real thing.

**TIEMCO™
SHIMAZAKI™
DRY SHAKE
DUN**

\$93.40/10



ITEM	CODE	COST	SRP
EACH	30255	\$9.34	\$16.99 EA
10-PACK	30254	\$93.40	\$16.99 EA

Great for drying and reconditioning your dun colored flies. When your dry fly begins to sink, just put it in the dry shake container and shake it. The absorbing powder in the bottle removes the moisture from the fly and coats it with a water resistant material. Your fly will again float like new.

**TIEMCO™
SHIMAZAKI™
DRY SHAKE
WITH APPLICATOR
BRUSH**

\$137.40/10



ITEM	CODE	COST	SRP
EACH	30297	\$13.74	\$24.99 EA
10-PACK	30298	\$137.40	\$24.99 EA

Now anglers can apply the world's best shake with an applicator brush with greater precision and control.

**TIEMCO™
SHIMAZAKI™
DRY SHAKE
REFILL**

\$137.40/10



ITEM	CODE	COST	SRP
EACH	30287	\$13.74	\$24.99 EA
10-PACK	30288	\$137.40	\$24.99 EA

Reenergize your existing Shimazaki Dry Shake Original with just the powder. This convenient container of Original Shake — minus the crystals — will let you refill that original container two times.

**TIEMCO™
DRY MAGIC**

\$93.40/10



ITEM	CODE	COST	SRP
EACH	30247	\$9.34	\$16.99 EA
10-PACK	30248	\$93.40	\$16.99 EA

A unique silicone floatant that works wonders on all dry flies, including CDC.

**UMPQUA™
BUG BUTTER**

\$96.00/25



ITEM	CODE	COST	SRP
EACH	30289	\$3.84	\$6.99 EA
25 COUNT	30290	\$96.00	\$6.99 EA

This clear floatant becomes a semi-solid when immersed in cold water, repelling moisture and keeping your dry fly floating longer. Designed not to melt in hot weather.

**BUG FLOTE
0.5 OZ BOTTLE**

\$46.13/12



CASE	CODE	COST	SRP
EACH	30295	\$3.84	\$6.99/EA
12-PACK	30251	\$46.13	\$6.99/EA

STREAMSIDE ACCESSORIES



FLIES

LEADER & TIPPET

PACKS & BAGS

ACCESSORIES

HOOKS

TOOLS & KITS

TYING MATERIALS

NECKS & SADDLES

LINE DRESSINGS & CLEANER

**TIEMCO™
LINE CLEANER**

\$93.45/10



QUANTITY	CODE	SRP
10-PACK	30490	\$16.99 EA

**GLIDE® LINE
DRESSING
WITH
APPLICATOR
BOX**

\$29.99 EACH

NEW



NOW TWICE THE VOLUME

PRODUCT	CODE	COST	SRP
DRESSING AND BOX	30633	\$16.49	\$29.99 EA
LINE DRESSING ONLY (6PK)	30495	\$82.47	\$24.99 EA
DRESSING BOX ONLY (6PK)	30630	\$23.07	\$6.99 EA

**RUSS PEAK
LINE DRESSING**

\$46.17/6



QUANTITY	CODE	SRP
6-PACK	30499	\$13.99

LEADER ACCESSORIES

**UMPQUA™
TIPPET RINGS PREMIUM
10 PACK**

\$8.24 EACH



CODE	COST	SRP
59195	\$8.24	\$14.99

The easy & effective way to connect a tippet to a leader. Simply knot your leader/tippet to the tippet ring before sliding the ring off of the wire.

- 2mm Diameter
- High Strength (26lb)
- Smooth Polish - will not weaken line
- Corrosion Resistant
- Anodized, High Grade Alloy
- Low Reflection

**UMPQUA™
TIPPET RINGS STD
10-PACK**

\$4.12 EACH

NEW



CODE	COST	SRP
59197	\$4.12	\$7.49

Simplify adjustments and replacements in your Euro-nymphing setup with these small, smooth 2mm rings. Effortlessly connect varying tippet diameters, ensuring seamless transitions and ease of use. Simply knot your leader/tippet to the tippet ring before sliding the ring off of the wire.

- 2mm Diameter
- High Strength (26lb)
- Smooth Polish - will not weaken line
- Corrosion Resistant
- Japanese Stainless Steel, Black Nickel Finish
- Low Reflection

**UMPQUA
COMBO LINE
STRAIGHTENER/
CLEANER**

\$10.99 EACH



CODE	COST	SRP
30544	\$10.99	\$19.99

This handsome combo line straightener/cleaner quickly dries fly lines and straightens leaders.

**LEADER
STRAIGHTENER**

\$3.84 EACH



CODE	SRP
30550	\$6.99

STREAMSIDE ACCESSORIES



FLIES

LEADER & TIPPET

PACKS & BAGS

ACCESSORIES

HOOKS

TOOLS & KITS

TYING MATERIALS

NECKS & SADDLES

PACK GADGETS

UMPQUA CLIP RETRACTOR SMALL

\$8.24 EACH



SIZE	CODE	COST	SRP
1.25" DIA	33060	\$8.24	\$14.99

Tired of losing your fishing gear? This Umpqua retractor makes your accessories easily accessible so everything you need is always in reach.

- Extra Long 36" Nylon Cord
- Split Ring Secure Tool Attachment
- 2 oz. Heavy Duty Retraction Force
- Secure & Easy Belt Clip On Attachment
- Tested to 1000 pulls
- 1.25" Diameter
- Lifetime Warranty

UMPQUA PIN RETRACTOR SMALL

\$8.24 EACH



SIZE	CODE	COST	SRP
1.25" DIA	31185	\$8.24	\$14.99

Small but mighty, our small pin retractors have been tested in excess of one million pulls and are the standards of excellence in small fishing zingers.

- Extra Long 36" Nylon Cord
- Split Ring Secure Tool Attachment
- 2 oz. Retraction Force
- Secure and Easy Pin On Attachment
- Tested to One Million Pulls
- 1.25" Diameter
- Lifetime Warranty

UMPQUA CARABINER RETRACTOR MEDIUM

\$10.99 EACH



SIZE	CODE	COST	SRP
1.5" DIA	31186	\$10.99	\$19.99

This medium-sized zinger uses a light-weight zinc alloy carabiner that attaches to almost anything. Comes with a heavy-duty Kevlar® cord and durable polycarbonate case.

- Heavy-Duty 24" Kevlar® Cord
- Split Ring Secure Tool Attachment
- 4 oz. Retraction Force
- Secure and Easy Carabiner Attachment
- Tested to One Million Pulls
- 1.5" Diameter
- Durable Polycarbonate Case
- Lifetime Warranty

UMPQUA CLIP RETRACTOR LARGE

\$10.99 EACH



SIZE	CODE	COST	SRP
1.75" DIA	33065	\$10.99	\$19.99

The largest of Umpqua retractors, this large zinger has a longer reach and heavier retraction force than its smaller siblings. Ideal for those larger accessories and gear that you need constant access to.

- Extra Long 36" Nylon Cord
- Split Ring Secure Tool Attachment
- 6 oz. Heavy Duty Retraction Force
- Secure & Easy Belt clip attachment
- Tested to 1000 pulls
- 1.75" Diameter
- Lifetime Warranty

ZERO SWEEP™ FOAM FLY PATCH

\$4.39 EACH



COLOR	CODE	COST	SRP
OLIVE	35271	\$4.39	\$7.99

Attach this handy foam on any of the ZS2 packs and bags for quick access to the flies you need most.

UMPQUA™ 4-WAY SPLIT SHOT ASSORTMENT LEAD

\$7.42 EACH



CASE	CODE	SRP
4-WAY ASSORTMENT	32040	\$13.49/EA

Conveniently carry split shot with Umpqua's 4-Way Split Shot Assortment. An easy-to-use rotating selector readily identifies shot size and makes selecting shot easy. Most split shot for the money of any 4-way shot dispenser!

- Following are the four different sizes and quantities
- 0 (0.48g) Quantity 30
 - 2 (0.30g) Quantity 45
 - 4 (0.20g) Quantity 60
 - 6 (0.12g) Quantity 125

STREAMSIDE ACCESSORIES

STREAM THERMOMETER

\$9.34 EACH



CODE	SRP
30960	\$16.99

TIEMCO™ CERAMIC HOOK HONE

\$12.64 EACH



CODE	SRP
30900	\$22.99

WONDER CLOTH DRY FLY PATCH

\$3.02 EACH



SIZE	CODE	SRP
7" x 3"	31100	\$5.49

Great for rejuvenating dry flies that don't float as well as they should! This cloth is able to absorb 8x its weight in moisture - which means it sucks the water right out of your fly and gets you back to fishing faster.

50 COUNT ZINGERS CLIP ON PIN ON

\$192.00/50



QTY	CODE	COST	SRP
50 COUNT CLIP ON	30751	\$192.00	\$6.99 EA
EACH CLIP ON	30753	\$3.84	\$6.99 EA
50 COUNT PIN ON	30761	\$192.00	\$6.99 EA
EACH PIN ON	30763	\$3.84	\$6.99 EA

*NEW Cardboard packaging in 2024

FLIES

LEADER & TIPPET

PACKS & BAGS

ACCESSORIES

HOOKS

TOOLS & KITS

TYING MATERIALS

NECKS & SADDLES

TOOLS

DREAM STREAM™ TOOLS

Meet our line of value, high-quality and dependable tools with great prices. All Dream Stream™ tools are made with surgical-grade Japanese stainless steel to exacting specifications for fly-fishers to ensure that every cut, crimp and clamp they make on the water are good ones.

All Dream Stream™ tools are available in either a matte black finish or a bright anodized red finish.

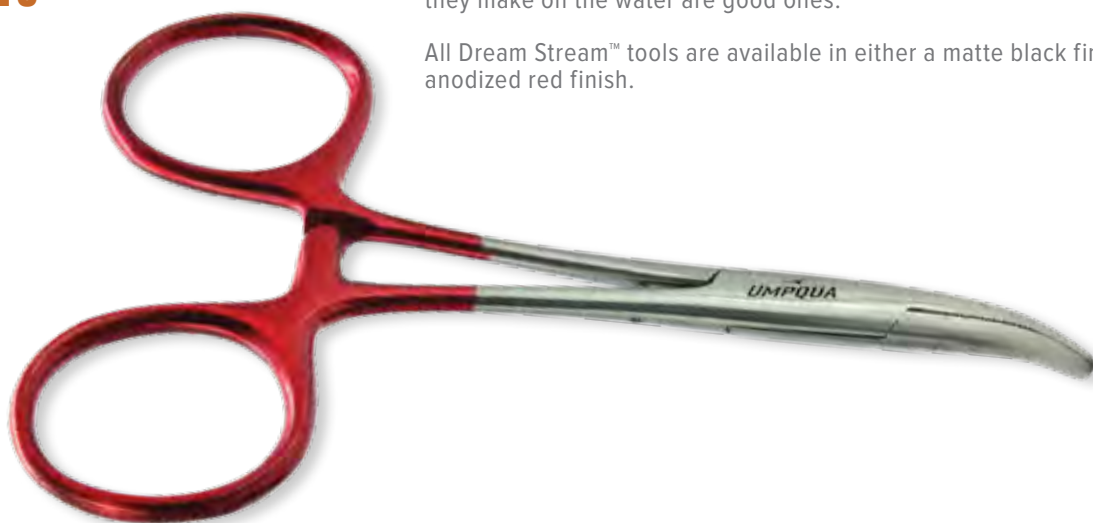

DREAM STREAM™ MAGNETIC NET RELEASE

\$10.99 EACH



CARABINER AND LANYARD NOT SHOWN

COLOR	CODE	SRP
BLACK	31151	\$19.99
RED	31152	\$19.99

Hold your net securely and access easily! Give a firm tug on your net to separate the two strong magnets, and you're good! Carabiner clips to the D-ring on your vest while using a split ring to attach to your lanyard/net.

- Powerful Magnet – 8lb/3.5kg
- Aviation Grade Aluminum
- Corrosion-Resistant Materials
- Streamlined Shape (prevents snagging)
- Includes Lanyard

DREAM STREAM™ ZINGER/NIPPER COMBO

\$6.59 EACH



COLOR	CODE	SRP
BLACK	31183	\$11.99
RED	31184	\$11.99

This kit contains two of the most important accessories any angler must have. It includes a clip-on retractor and a Dream Stream™ nipper. Simply attach the nipper to the retractor and clip to vest or pack to keep the nipper at your fingertips.

DREAM STREAM™ ZINGER/CLAMP/NIPPER KIT

\$10.99 EACH



COLOR	CODE	SRP
BLACK	30783	\$19.99
RED	30784	\$19.99

Whether tying on a new fly or releasing a fish, this kit has everything you need. Includes a clip-on retractor, nipper and 5" clamp/hemostat. Simply attach the nipper to the retractor and clip to vest or pack to keep nipper at your fingertips.

STREAMSIDE ACCESSORIES

**DREAM STREAM™
5" CLAMP
STRAIGHT** \$5.49 EACH



COLOR	CODE	SRP
BLACK	30602	\$9.99
RED	30603	\$9.99

A traditional favorite among fishermen, this half-serrated, half-smooth jawed clamp with a hook eye cleaner has everything you need and nothing more.

**DREAM STREAM™
5" CLAMP
CURVED** \$5.49 EACH



COLOR	CODE	SRP
BLACK	30604	\$9.99

Curved-jawed clamps seem to make everything easier. Half-serrated, half-smooth jaws clamp with a hook eye cleaner make this a great all-around clamp.

**DREAM STREAM™
5" SPRING CREEK
CLAMP
STRAIGHT** \$6.04 EACH



COLOR	CODE	SRP
BLACK	30606	\$10.99

A must have for tail-water anglers who fish tiny flies. The smooth jaws of this ultra-fine clamp will crimp barbs down to size #26's.

**DREAM STREAM™
NIPPER** \$2.74 EACH
\$137.00/50



COLOR	CODE	SRP
BLACK	30663	\$4.99
BUCKET ASST 50CT — BLACK & RED	30610	\$4.99

Workhorse nippers with hook eye cleaner — at a great price.

**DREAM STREAM™
HOOK FILE** \$5.49 EACH



COLOR	CODE	SRP
BLACK	30600	\$9.99

Don't neglect your hook points if you want to consistently hook and hold fish. This two-sided file has grooves for sharpening the hook's bottom and flat areas for the sides of the hook.

**DREAM STREAM™
25 CLAMPS** \$137.36/25



COLOR/QTY	CODE	SRP
MIXED 25 COUNT	31193	\$9.99 EA

All anglers can always use a spare great quality, low cost clamp... and with this bucket of Dream Stream™ clamps on the shelf or next to the register, they'll be sure to grab one.

*NEW Cardboard packaging in 2024

FLIES

LEADER & TIPPET

PACKS & BAGS

ACCESSORIES

HOOKS

TOOLS & KITS

TYING MATERIALS

NECKS & SADDLES

TOOLS

NEW

RIVER GRIP™ PS PRECISION SERIES TOOLS

RiverGrip Precision Series tools are designed with comfort and precision in mind. Dual-layered, rubberized handles allow comfortable cutting, pinching and gripping while new finely tapered jaws, finger extensions (hemostats) and ergonomic ridges/cutouts (nippers) maximize precise functionality. Made with surgical-grade Japanese steel.

RIVER GRIP™ PS ZINGER/CLAMP/ NIPPER KIT

\$15.94 EACH



COLOR	CODE	SRP
BLACK	33186	\$28.99
RED	33187	\$28.99
HOT ORANGE	33188	\$28.99

Whether tying on a new fly or releasing a fish, this kit has everything you need. Includes a clip-on retractor, nipper and 5" clamp/hemostat. Simply attach the nipper to the retractor and clip to vest or pack to keep nipper at your fingertips.

RIVER GRIP™ PS ZINGER/NIPPER COMBO

\$8.24 EACH



COLOR	CODE	SRP
BLACK	33183	\$14.99
RED	33184	\$14.99
HOT ORANGE	33185	\$14.99

Two of the most important and most-used accessories for any angler in one combo pack. Includes a clip-on retractor, and a River Grip PS Nipper. Simply attach the nipper to the retractor and clip to vest or pack to keep nipper at your fingertips.

RIVER GRIP™ PS 6" SCISSOR CLAMP STRAIGHT

\$10.99 EACH



COLOR	CODE	SRP
BLACK	33180	\$19.99
RED	33181	\$19.99
HOT ORANGE	33182	\$19.99

The workhorse and first choice of most guides, this beefy scissor clamp will crimp barbs, cut line or even a small branch to free snagged flies. Features one oversized finger loop for easy use. The jaws are half-serrated, half smooth. Precision-tip jaw and finger extension for maximum control and accuracy.

RIVER GRIP™ PS 6" SCISSOR CLAMP OPEN STRAIGHT

\$10.99 EACH



COLOR	CODE	SRP
BLACK	33175	\$19.99
RED	33176	\$19.99
HOT ORANGE	33177	\$19.99

Featuring an open-loop grip for easy operation, this workhorse scissor clamp will pinch barbs, cut line and unhook fish day-after-day. The jaws are half-serrated, half smooth. Precision-tip jaw and finger extension for maximum control and accuracy.

RIVER GRIP™ PS 6" SCISSOR CLAMP CURVED

\$10.99 EACH



COLOR	CODE	SRP
BLACK	33152	\$19.99
RED	33153	\$19.99
HOT ORANGE	33154	\$19.99

Curved-jaw clamps seem to make everything easier. This beefy scissor clamp will crimp barbs, cut line or even a small branch to free snagged flies. Features one oversized finger loop for easy use. The jaws are half-serrated, half smooth. Precision-tip jaw and finger extension for maximum control and accuracy.

RIVER GRIP™ PS 5" DEBARB PLIERS

\$7.14 EACH



COLOR	CODE	SRP
BLACK	33178	\$12.99
RED	33179	\$12.99

If you do a lot of detailed work on small flies (pinch barbs and removing small flies from hooked fish) this tool was made for you. Fine jaws and head make it easy to access what you need in these tough situations.

STREAMSIDE ACCESSORIES

RIVER GRIP™ PS 5" CLAMP CURVED

\$7.69 EACH



COLOR	CODE	SRP
BLACK	33155	\$13.99
RED	33156	\$13.99
HOT ORANGE	33157	\$13.99

Curved-jaw clamps seem to make everything easier. Half-serrated, half-smooth jaws and hook eye cleaner make this a great all-around clamp. Precision-tip jaw and finger extension for maximum control and accuracy.

RIVER GRIP™ PS 5" CLAMP STRAIGHT

\$7.69 EACH



COLOR	CODE	SRP
BLACK	33158	\$13.99
RED	33159	\$13.99
HOT ORANGE	33160	\$13.99

A long-time favorite, this half-serrated, half-smooth jawed clamp with hook-eye cleaner is all you need and nothing more. Precision-tip jaw and finger extension for maximum control and accuracy.

RIVER GRIP™ PS 4" CUT-ALL BENCH TOOL

\$5.49 EACH



COLOR	CODE	SRP
BLACK	33150	\$9.99
RED	33151	\$9.99

Don't ruin your expensive tools on wire and heavy materials. The Cut-All Bench Tool has you covered for this dirty work. You will be reaching for this one a lot!

RIVER GRIP™ PS 5.5" ULTRA MITTEN CLAMP

\$13.74 EACH



COLOR	CODE	SRP
BLACK	33164	\$24.99
RED	33165	\$24.99
HOT ORANGE	33166	\$24.99

This cold-weather favorite makes it easy to open and close with numb fingers or gloves. It requires no fingers for operation and comes with half-serrated, half smooth jaws. Precision-tip jaw and finger extension for maximum control and accuracy.



FLIES

LEADER & TIPPET

PACKS & BAGS

ACCESSORIES

HOOKS

TOOLS & KITS

TYING MATERIALS

NECKS & SADDLES

TOOLS

NEW

RIVER GRIP™ PS NIPPER

\$4.39 EACH



COLOR	CODE	SRP
BLACK	33167	\$7.99
RED	33168	\$7.99
HOT ORANGE	33169	\$7.99

Our "River Nip" Nippers are a cut above the rest with ergonomic cut-out and thumb-bump for easy handling and precision cutting.

- Pin eye-cleaner
- Free-rotating ring attachment

RIVER GRIP™ NIP PS TUNGSTEN CARBIDE

\$7.14 EACH



COLOR	CODE	SRP
BLACK	33172	\$12.99
RED	33173	\$12.99
HOT ORANGE	33174	\$12.99

Our "River Nip" tungsten nippers are a cut above the rest. Tungsten carbide construction makes this a nipper that will not only stay sharp but last long. With ergonomic cut-out and thumb-bump for easy handling and precision cutting.

- Pin eye-cleaner
- Free-rotating ring attachment

RIVER GRIP™ PS BIG NIP

\$7.14 EACH



COLOR	CODE	SRP
BLACK	33143	\$12.99
RED	33144	\$12.99
HOT ORANGE	33145	\$12.99

Our "Big Nip" Nippers are a cut above the rest with ergonomic cut-out and thumb-bump for easy handling and precision cutting.

- Pin eye-cleaner
- Free-rotating ring attachment

RIVER GRIP™ PS BIG NIP TC TUNGSTEN CARBIDE

\$10.99 EACH



COLOR	CODE	SRP
BLACK	33147	\$19.99
RED	33148	\$19.99
HOT ORANGE	33149	\$19.99

Our "Big Nip" Nippers are a cut above the rest. Tungsten carbide construction makes this a nipper that will not only stay sharp but last long. With ergonomic cut-out and thumb-bump for easy handling and precision cutting.

- Pin eye-cleaner
- Free-rotating ring attachment

RIVER GRIP™ PS NIP & LANYARD

\$7.69 EACH



COLOR	CODE	SRP
HOT ORANGE & BLACK	33170	\$13.99

Our "Big Nip" Nippers are a cut above the rest. Tungsten carbide construction makes this a nipper that will not only stay sharp but last long. With ergonomic cut-out and thumb-bump for easy handling and precision cutting. A great combination to keep your nippers handy at all times. Lanyard is slide-adjustable and includes swivel between lanyard and nipper.

- Pin eye-cleaner
- Free-rotating ring attachment

RIVER GRIP™ PS BIG NIP & LANYARD

\$10.99 EACH



COLOR	CODE	SRP
HOT ORANGE & BLACK	33146	\$19.99

Our "Big Nip" Nippers are a cut above the rest. Tungsten carbide construction makes this a nipper that will not only stay sharp but last long. With ergonomic cut-out and thumb-bump for easy handling and precision cutting. A great combination to keep your nippers handy at all times. Lanyard is slide-adjustable and includes swivel between lanyard and nipper.

- Pin eye-cleaner
- Free-rotating ring attachment

RIVER GRIP™ PS HOOK FILE

\$5.49 EACH



COLOR	CODE	SRP
BLACK	33161	\$9.99
RED	33162	\$9.99

Don't neglect your hook points if you want to consistently land fish. This two-sided file has grooves on both sides (two on one side and one on the other). Use grooves for sharpening bottom of hooks and flat surface for sharpening sides.

RIVER GRIP™ PS LANYARD

\$3.29 EACH



COLOR	CODE	SRP
BLACK	33163	\$5.99

A great combination to keep your gear handy at all times. Lanyard is slide-adjustable.

STREAMSIDE ACCESSORIES

RIVER GRIP™ PS NIP 50 COUNT \$219.73/50



COLOR	CODE	SRP
ASSORTED	33194	\$7.99 EACH

An ideal and handy way to get these great Nippers in front of every one of your customers.

RIVER GRIP™ PS BIG NIP 25 COUNT \$178.61/25



COLOR	CODE	SRP
ASSORTED	33190	\$12.99

An ideal and handy way to get these great Big Nippers in front of every one of your customers.

RIVER GRIP™ PS HEMO 5" 25 COUNT \$192.36/25



COLOR	CODE	SRP
ASSORTED	33191	\$13.99

An ideal and handy way to get these great 5" Hemos in front of every one of your customers.

RIVER GRIP™ PS NIP & LANYARD 25 COUNT \$206.11/25



COLOR	CODE	SRP
HOT ORANGE & BLACK	33192	\$13.99

An ideal and handy way to get these great Nippers with a lanyard in front of every one of your customers.

RIVER GRIP™ PS BIG NIP & ZINGER 25 COUNT \$205.98/25



COLOR	CODE	SRP
HOT ORANGE & BLACK	33193	\$14.99

An ideal and handy way to get these great Nippers complete with Umpqua Zinger in front of every one of your customers.



Umpqua is making the switch to cardboard for our counter top displays. Recyclable and eye-catching, we're excited to have our larger selections of tools at the ready in your shops.

FLIES

LEADER & TIPPET

PACKS & BAGS

ACCESSORIES

HOOKS

TOOLS & KITS

TYING MATERIALS

NECKS & SADDLES



UM

APPAREL & MERCHANDISE



291

- FLIES
- LEADER & TIPPET
- PACKS & BAGS
- ACCESSORIES
- HOOKS
- TOOLS & KITS
- TYING MATERIALS
- NECKS & SADDLES

HATS

NEW

**UFM FLYER
FLY FISHING
ROPE CAP- MESH BACK**

\$16.49 EACH



COLOR	CODE	SRP
OLIVE/ WHITE	75730	\$29.99

Guaranteed to help you cast further, hook set faster, and land you more fish... UFM Flyers*. Unstructured, Low Profile, 3D Embroidery, throw-back rope cap with mesh back panels. Let the world know you fish.

NEW

**STREAMER COWBOY
ROPE CAP- MESH BACK**

\$16.49 EACH



COLOR	CODE	SRP
BROWN/ BURNT ORANGE	75732	\$29.99

Yeehaw. Unstructured, Low Profile, Woven Patch, throw-back rope cap. Grab your biggest streamer, and see what you can lasso up.

NEW

**THUNDER THIGHS
ROPE CAP**

\$16.49 EACH



COLOR	CODE	SRP
DARK GREEN/ GOLD	75736	\$29.99

Nothing beats a summer's day on the river with the hoppers all around you. Paremore's™ Thunder Thighs can ride high with the best of them and help you land that monster. Unstructured, Low Profile, High Detail Embroidery, throw-back rope cap. Let the world know how you fish

NEW

**IT STARTS WITH THE FLY CAP
ROPE CAP**

\$16.49 EACH



COLOR	CODE	SRP
DARK GRAY/ BLACK	75737	\$29.99

Sometimes we get a new fly that feels like it's been around forever. Antonio's Emerger feels like it's part of the old guard, but with a modern bend. It starts with the fly, and ends with the best day on the water. Unstructured, Embroidery, throw-back rope cap.

APPAREL & MERCHANDISE



FLIES

LEADER & TIPPET

PACKS & BAGS

ACCESSORIES

HOOKS

TOOLS & KITS

TYING MATERIALS

NECKS & SADDLES

HATS

NEW

IT STARTS WITH THE FLY SP CAP
MESH ROPE CAP

\$16.49 EACH



COLOR	CODE	SRP
NAVY/ NAVY	75735	\$29.99

It starts with the fly, and ends with your best day on the water. Show it off. Unstructured, Low Profile, Screen Print & Embroidery, throw-back rope cap with mesh back panels.

NEW

UMPQUA PATCH
FOAM TRUCKER

\$16.49 EACH



COLOR	CODE	SRP
WHITE/ GRAY	75734	\$29.99

Commemorate a great day of fishing with a true classic. Semi-structured, Foam, Medium/high Profile, Mesh Back Trucker.

NEW

CLOUSER-CLASSIC CAP
ROPE CAP

\$16.49 EACH



COLOR	CODE	SRP
KHAKI/BLUE	75731	\$29.99

Unstructured, Low Profile, Woven Patch, throw-back rope cap. Stick to the classics with a tried and true pattern and cap. Brown underbrim to reduce glare

NEW

RETRO FLY PATCH CAP
RICHARDSON MESH TRUCKER

\$16.49 EACH



COLOR	CODE	SRP
BEIGE/ CHARCOAL/ AMBER	75733	\$29.99

Richardson 112 Trucker cap fits nearly everyone, so let's make sure y'all get one for yourself. Structured, Medium Profile, Mesh Back Trucker. A woven patch showing off a classic wetfly.

APPAREL & MERCHANDISE

NEW

CAMO LOGO EMBROIDERY CAP
RICHARDSON MESH TRUCKER

\$16.49 EACH



COLOR	CODE	SRP
BLACK CAMO/ BLACK	75760	\$29.99

Brand New Richardson 112 Trucker camo cap fits nearly everyone, so let's make sure y'all get one for yourself. Structured, Medium Profile, Mesh Back Trucker. Black on black with black, simple and effective.

NEW

IT STARTS WITH THE FLY TRUCKER CAP
RICHARDSON MESH TRUCKER

\$16.49 EACH



COLOR	CODE	SRP
DARK GRAY/ BLACK	75738	\$29.99

Structured, Medium Profile, Mesh Back Trucker - Commemorate a great day of fishing some dries, or anything else on the water.

NEW

RELAXED DRY FLY EMBROIDERY CAP
SOFT MESH CAP

\$16.49 EACH



COLOR	CODE	SRP
DARK MUSTARD/ KHAKI	75741	\$29.99

Our UFM Flyer design in a classic cap design. Unstructured, Low Profile, Relaxed fit, Soft Mesh cap - Rep the classics, and catch some big Bows this year.

NEW

SOFT MESH LOGO CAP
SOFT MESH CAP

\$16.49 EACH



COLOR	CODE	SRP
MOSS/ KHAKI	75742	\$29.99

Unstructured, Low Profile, Soft Mesh cap - Commemorate a great day of fishing with a comfy classic.

NEW

MATCH THE HATCH CAP
MINI LEECH JIG RADIANT
MESH TRUCKER

\$16.49 EACH



COLOR	CODE	SRP
HEATHER GRAY/ BLACK	75739	\$29.99

Structured, High Profile, Mesh trucker - It's always Leech Season!

NEW

MATCH THE HATCH CAP
MISSING LINK
ROPE CAP

\$16.49 EACH



COLOR	CODE	SRP
KHAKI/ BROWN	75740	\$29.99

Unstructured, Medium Profile, Rope Cap - Classic Fly, Classic Cap.

FLIES

LEADER & TIPPET

PACKS & BAGS

ACCESSORIES

HOOKS

TOOLS & KITS

TYING MATERIALS

NECKS & SADDLES

HATS

**UFM FLYER
DRY FLY
ROPE CAP**

\$16.49 EACH



COLOR	CODE	SRP
NAVY/ WHITE	75454	\$29.99

Guaranteed to help you cast further, hook set faster, and land you more fish... UFM Flyers*. Unstructured, Low Profile, 3D Embroidery, throw-back rope cap. Let the world know how you fish.

**UFM FLYER
STREAMER JUNKIE
CORDUROY ROPE CAP**

\$16.49 EACH



COLOR	CODE	SRP
GRAY/ WHITE	75452	\$29.99

Guaranteed to help you cast further, hook set faster, and land you more fish... UFM Flyers*. Unstructured, Low Profile, 3D Embroidery, throw-back corduroy rope cap. Let the world know how you fish.

**UFM FLYER
EURO NYMPH
ROPE CAP**

\$16.49 EACH



COLOR	CODE	SRP
GREEN/ WHITE	75453	\$29.99

Guaranteed to help you cast further, hook set faster, and land you more fish... UFM Flyers*. Unstructured, Low Profile, 3D Embroidery, throw-back rope cap. Let the world know how you fish.

**STIMI-CLASSIC
ROPE HAT**

\$16.49 EACH



COLOR	CODE	SRP
HONEY/ BROWN	75028	\$29.99

Structured, Low Profile, throw-back rope cap. Stick to the classics with a tried and true pattern and cap. Black underbrim to reduce glare

APPAREL & MERCHANDISE

MAYFLIER FLEX-FIT HAT

\$19.24 EACH



COLOR	CODE	SRP
BLACK	75027	\$34.99

Structured, Medium Profile, flex-fit cap. Gotta love those bugs.



FLIES

LEADER & TIPPET

PACKS & BAGS

ACCESSORIES

HOOKS

TOOLS & KITS

TYING MATERIALS

NECKS & SADDLES

HATS

OG EMBROIDERY CAP

\$16.49 EACH



COLOR	CODE	SRP
NAVY	75455	\$29.99

Unstructured, Low Profile, Metal clasp cap- Rep the classics, and catch some big Bows this year.

STONEFLY CRAWLER MESH TRUCKER

\$16.49 EACH



COLOR	CODE	SRP
KHAKI/ BLAZE ORANGE	75458	\$29.99

Structured, Medium Profile, Mesh Back Trucker - Commemorate a great day of fishing what some call "The Hatch"

MODERN CLASSIC CAP MESH RICHARDSON 112 CAP

\$16.49 EACH



COLOR	CODE	SRP
BLACK/ BLACK	75029	\$29.99

Structured, Medium Profile, Mesh-back Richardson 112 Trucker. - A tight woven patch to let those fish know who's boss.

CADDIS FLOAT LEATHER PATCH CAP MESH TRUCKER

\$16.49 EACH



COLOR	CODE	SRP
TAN/ BROWN	75459	\$29.99

Structured, Medium Profile, Mesh Back Trucker. A classic leather patch showing off the classic hatch.

APPAREL & MERCHANDISE

MATCH THE HATCH NO HACKLE

\$16.49 EACH



COLOR	CODE	SRP
CYPRESS/COFFEE	75403	\$29.99

Structured, Low Profile, Canvas/Mesh Back Trucker - A sweet and stealthy lid great for sneaking up on trout or ducking into the local watering hole.

MATCH THE HATCH HIPPIE STOMPER

\$16.49 EACH



COLOR	CODE	SRP
MARSALA/GREY	75404	\$29.99

Structured, Low Profile, Canvas/Mesh Back Trucker - A sweet and stealthy lid great for sneaking up on trout or ducking into the local watering hole.

CLASSIC CAP

\$16.49 EACH



COLOR	CODE	SRP
WHISKEY	75025	\$29.99

Part-structured, Low Profile, Cap, Leather closure - Show your love for Nymphing and a great CDC collar.

MATCH THE HATCH SPARKLE DUN

\$16.49 EACH



COLOR	CODE	SRP
OLIVE/BLACK	75405	\$29.99

Structured, Low Profile, Canvas/Mesh Back Trucker - A sweet and stealthy lid great for sneaking up on trout or ducking into the local watering hole.

CLASSIC CAP

\$16.49 EACH



COLOR	CODE	SRP
WHISKEY	75398	\$29.99

Structured, Low Profile, Canvas Trucker - Clean and strong design

CLASSIC MESH CAP MESH CAP

\$16.49 EACH



COLOR	CODE	SRP
HARBOR/ KHAKI	75399	\$29.99

Slightly curved brim Brim, Medium profile Corduroy cap, Trucker - Clean and strong design

FLIES

LEADER & TIPPET

PACKS & BAGS

ACCESSORIES

HOOKS

TOOLS & KITS

TYING MATERIALS

NECKS & SADDLES

SHIRTS

NEW

STREAMER COWBOY TEE

\$16.49 EACH



COLOR	SIZE	CODE	PRICE	SRP
CREAM	S	75724	\$16.49	\$29.99
	M	75725	\$16.49	\$29.99
	L	75726	\$16.49	\$29.99
	XL	75727	\$16.49	\$29.99
	XXL	75728	\$18.14	\$32.99
	XXXL	75729	\$19.24	\$34.99

Men's Vintage Short Sleeve Tee- Show off your fly choice, give those fish some Streamer action and let everyone know you're a fly fisher.

NEW

TROUT COUNTRY TEE

\$16.49 EACH



COLOR	SIZE	CODE	PRICE	SRP
DARK HEATHER	S	75718	\$16.49	\$29.99
	M	75719	\$16.49	\$29.99
	L	75720	\$16.49	\$29.99
	XL	75721	\$16.49	\$29.99
	XXL	75722	\$18.14	\$32.99
	XXXL	75723	\$19.24	\$34.99

Men's Vintage Short Sleeve Tee- We're all together living in the same world, Trout Country.

NEW



IT STARTS WITH THE FLY TEE

\$16.49 EACH

COLOR	SIZE	CODE	PRICE	SRP
MILITARY GREEN	S	75712	\$16.49	\$29.99
	M	75713	\$16.49	\$29.99
	L	75714	\$16.49	\$29.99
	XL	75715	\$16.49	\$29.99
	XXL	75716	\$18.14	\$32.99
	XXXL	75717	\$19.24	\$34.99

Men's Vintage Short Sleeve Tee- Dry fly enthusiasts, nymph fans, streamer junkies; we all know it starts with the fly. Share your love.

APPAREL & MERCHANDISE

LOGO TEE



COLOR	SIZE	CODE	PRICE	SRP
BLACK	M	75526	\$16.49	\$29.99
	L	75527		
	XL	75528		
	XXL	75529		
PREMIUM HEATHER	M	75530		\$29.99
	L	75531		
	XL	75532		
	XXL	75533		

Men's Vintage Short Sleeve Tee- You can never go wrong with the basics. Umpqua Gear for the Umpqua Lover

NEW

PREMIUM LOGO HOODIE

\$32.99-35.74 EACH



COLOR	SIZE	CODE	PRICE	SRP
DARK GRAY/ PREMIUM HEATHER	S	75754	\$32.99	\$58.99
	M	75755		
	L	75756		
	XL	75757		
	XXL	75758	\$35.74	\$64.99
	XXXL	75759		

Premium lined Hoodie - You can never go wrong with the basics. Umpqua Gear for the Umpqua Lover



THE FEATHER MERCHANT PUB

\$16.49 EACH

COLOR	SIZE	CODE	SRP
HEATHER RED	SM	75701	\$29.99
	M	75702	
	L	75703	
	XL	75704	
	XXL	75705	
NAVY	SM	75706	\$29.99
	M	75707	
	L	75708	
	XL	75709	
	XXL	75710	

Men's Vintage Short Sleeve Tee - Come on down to the local watering hole. Tie one on while you're there, and let's share good stories and a good time.

FLIES

LEADER & TIPPET

PACKS & BAGS

ACCESSORIES

HOOKS

TOOLS & KITS

TYING MATERIALS

NECKS & SADDLES

STICKERS

UMPQUA 6-PACK OF STICKERS

\$9.34 PACK



NEW

UMPQUA 6-PACK OF OBX STICKERS

\$8.24 PACK



CODE	SRP
75297	\$2.49 EA

Six stickers to share your love of life on the water. To be sold together or individually.

CODE	SRP
75768	\$2.49 EA

Six stickers to share your love of life on the water. To be sold together or individually.

NOW AVAILABLE INDIVIDUALLY- 10 PACKS

NEW

UMPQUA 10-PACK OF STREAMER COWBOY STICKERS

\$21.99 PACK



CODE	SRP
75296-10	\$3.99 EA

Ten stickers to share your love of life on the water. To be sold together or individually. 6" x 4"

NEW

UMPQUA 10-PACK OF TARPON SURFER STICKERS

\$21.99 PACK



CODE	SRP
75767-10	\$3.99 EA

Ten stickers to share your love of life on the water. To be sold together or individually. 6" x 3.5"- Tarpon Toad II peels out as second sticker.

APPAREL & MERCHANDISE

NEW

UMPQUA 10-PACK OF OBX DRY FLY STICKERS

\$13.74 PACK



CODE	SRP
75762-10	\$2.49 EA

Ten stickers to share your love of life on the water. To be sold together or individually. 5" x 3"

NEW

UMPQUA 10-PACK OF OBX STREAMER JUNKIE STICKERS

\$13.74 PACK



CODE	SRP
75761-10	\$2.49 EA

Ten stickers to share your love of life on the water. To be sold together or individually. 5" x 3"

NEW

UMPQUA 10-PACK OF OBX EURO NYMPH STICKERS

\$13.74 PACK



CODE	SRP
75763-10	\$2.49 EA

Ten stickers to share your love of life on the water. To be sold together or individually. 5" x 3"

NEW

UMPQUA 10-PACK OF OBX FLY FISH STICKERS

\$13.74 PACK



CODE	SRP
75292-10	\$2.49 EA

Ten stickers to share your love of life on the water. To be sold together or individually. 5" x 3"

NEW

UMPQUA 10-PACK OF OBX BASS POPPER STICKERS

\$13.74 PACK



CODE	SRP
75764-10	\$2.49 EA

Ten stickers to share your love of life on the water. To be sold together or individually. 5" x 3"

NEW

UMPQUA 10-PACK OF OBX FLATS CRAB STICKERS

\$13.74 PACK



CODE	SRP
75765-10	\$2.49 EA

Ten stickers to share your love of life on the water. To be sold together or individually. 5" x 3"

NEW

UMPQUA 10-PACK OF JAWS STICKERS

\$13.74 PACK



CODE	SRP
75291-10	\$2.49 EA

Ten stickers to share your love of life on the water. To be sold together or individually. 2.5" x 5"

NEW

UMPQUA 10-PACK OF BLACK STREAMER STICKERS

\$13.74 PACK

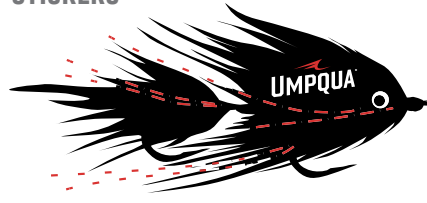

CODE	SRP
75294-10	\$2.49 EA

Ten stickers to share your love of life on the water. To be sold together or individually. 6" x 2.8"

NEW

UMPQUA 10-PACK OF RED MAYFLY STICKERS

\$10.99 PACK

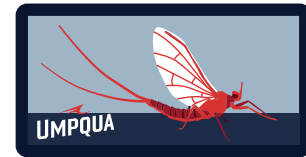

CODE	SRP
75766-10	\$1.99 EA

Ten stickers to share your love of life on the water. To be sold together or individually. 4" x 2"

NEW

UMPQUA 10-PACK OF UMPQUA HOOK STICKERS

\$10.99 PACK



CODE	SRP
75293-10	\$1.99 EA

Ten stickers to share your love of life on the water. To be sold together or individually. 3" x 1.5"

NEW

UMPQUA 10-PACK OF BLACK LOGO STICKERS

\$13.74 PACK



CODE	SRP
75295-10	\$2.49 EA

Ten stickers to share your love of life on the water. To be sold together or individually. 3.4" x 1.9"

FLIES

LEADER & TIPPET

PACKS & BAGS

ACCESSORIES

HOOKS

TOOLS & KITS

TYING MATERIALS

NECKS & SADDLES



NP	NICKEL PLATED
DS	DOUBLE SHANK
BLJ	BARBLESS BLACK JIG
Y	YAMAME/ JAPANESE TROUT (GENERALLY A LIGHT WIRE)
TR	TROUT
S	SALTWATER/ STAINLESS
BL	BARBLESS
SP	SUPER POINT
SP-BL	SUPER POINT AND BARBLESS
H	HEAVY WIRE
SP-BLB	SUPER POINT, BARBLESS + BLACK

TIEMCO™ HOOKS

“Just 5 flies tied on the real thing fish better than two dozen on imitations.”
-KEN SHIMAZAKI

Tiemco hooks were first made in 1984. That year was also during an American clamor to boycott Japanese products and buy American. Within a couple years the term “Japan bashing” was coined and Americans set upon Japanese cars. It was not an auspicious time to introduce Japanese hooks to the U.S. Undeterred, Umpqua’s founder, Dennis Black, one of America’s greatest commercial tiers, tested these new hooks, and with a simple handshake with Tiemco’s Toshi Shimoda, agreed to distribute them in the U.S. With that courageous decision, fly tying – and fly fishing – would be changed forever.

Tiemco’s hook designer, Ken Shimazaki, insisted on the most stringent quality control, using only the very best Japanese steel within tolerances measured in the 1/100 th of a millimeter. His designs were intended solely for fly tying and were the very first to be perfectly tempered, the first to offer chemically sharpened needle points and the first to introduce micro barbs. The first four models, TMC 100, 101, 200 and 300, were all of such a superior quality they ended the need for tiers to ever again have to inspect hooks for closed eyes or to tediously sharpen points before seating in the vise.

Tiemco quickly added the now familiar TMC 102Y, 5263, 3769 and 3761. These inspired hook designs were introduced to America in Umpqua’s 1985 catalog in a space that measured a mere 5 square inches—no explanation, no copy, just “Tiemco Hooks” and a small silhouette of each model.

It would take several years before American tiers would readily accept these Japanese imports. Nonetheless, American fly fishermen – and their fishing success – benefited quickly as Dennis Black started using Tiemco hooks in Umpqua’s fly production in Asia. Improvements in new fly design soon resulted as Dennis gave these first hooks to some of America’s best tiers and fly designers, introducing classic new patterns like Randall Kaufmann’s Stimulator, tied on the elegant TMC 200. With the initial manufacture of the first Tiemco hooks, fly tying, fly design, and fly fishing itself would all change...for the better.

Twenty-nine years later, Tiemco continues to be the standard against which all other fly tying hooks are compared and measured. Currently there are many claiming to compete with Tiemco, but Ken Shimazaki’s hook designs were so cutting edge that most simply copied Tiemco’s models, and some even plagiarized their model numbers. But as Ken would say, “Just 5 flies tied on the real thing (Tiemco) fish better than two dozen on imitations”.

305

FLIES

LEADER & TIPPET

PACKS & BAGS

ACCESSORIES

HOOKS

TOOLS & KITS

TYING MATERIALS

NECKS & SADDLES

DRY FLY HOOKS

TMC 100



Down Eye, 1X Fine, Wide Gape Forged, Bronze

QUANTITY	SIZE	CODE	COST	SRP
100PK	8	41006	\$18.42	\$33.50
	10	41007		
	12	41008		
	14	41009		
	16	41010		
	18	41011		
	20	41012		
	22	41013		
	24	41014		
	26	41015		
25PK	8	42006	\$5.44	\$9.90
	10	42007		
	12	42008		
	14	42009		
	16	42010		
	18	42011		
	20	42012		
	22	42013		
	24	42014		
	26	42015		

TMC100B



Down Eye, 1X Fine, Wide Gape Forged, Black

QUANTITY	SIZE	CODE	COST	SRP
25PK	10	42000	\$5.44	\$9.90
	12	42001		
	14	42002		
	16	42003		
	18	42004		
	20	42005		

TMC101



Straight Eye, 1X Fine, Wide Gape, Forged, Bronze

QUANTITY	SIZE	CODE	COST	SRP	
100PK	12	41036	\$18.42	\$33.50	
	14	41037			
	16	41038			
	18	41039			
	20	41040			
	22	41041			
	24	41042			
	25PK	12	42036	\$5.44	\$9.90
		14	42037		
		16	42038		
18		42039			
20		42040			
22		42041			

TMC102Y



Down Eye, 1X Fine, Wide Gape, Forged, Black

QUANTITY	SIZE	CODE	COST	SRP
100PK	11	41050	\$19.52	\$35.50
	13	41051		
	15	41052		
	17	41053		
	19	41054		
25PK	11	42050	\$5.81	\$10.55
	13	42051		
	15	42052		
	17	42053		
	19	42054		

TMC2312



— Caddis, Hoppers, Stoneflies & Terrestrials

QUANTITY	SIZE	CODE	COST	SRP
25PK	6	42110	\$6.88	\$12.50
	8	42111		
	10	42112	\$5.81	\$10.55
	12	42113		
	14	42114		
	16	42534		

TMC5212



Perfect Bend, Down Eye, 1X Fine, 2X Long, Forged, Bronze —
Caddis, Hoppers, Stoneflies & Terrestrials

QUANTITY	SIZE	CODE	COST	SRP
100PK	6	41097	\$19.46	\$35.40
	8	41098		
	10	41099		
	12	41100		
	14	41101		
	25PK	6	42097	\$5.73
8		42098		
10		42099		
12		42100		
14		42101		



DRY FLY HOOKS

BARBLESS

TMC921



Down Eye, 1X Fine, 2X Short, Forged, Bronze — *Parachutes & Thorax*

QUANTITY	SIZE	CODE	COST	SRP
25PK	14	42303	\$6.34	\$11.55
	16	42304		
	18	42305		

TMC9300

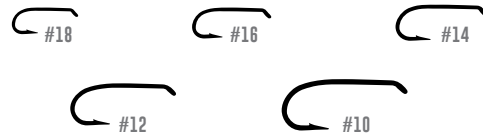

Down Eye, 1X Heavy, Wide Gape, Forged, Bronze — *Dry & Wet Flies*

QUANTITY	SIZE	CODE	COST	SRP
25PK	10	42045	\$5.44	\$9.90
	12	42046		
	14	42047		
	16	42048		
	18	42049		

TMC100BL



Down Eye, 1X Fine, Wide Gape, Forged, Barbless, Bronze — *Dry Flies*

QUANTITY	SIZE	CODE	COST	SRP
100PK	12	41021	\$18.42	\$33.50
	14	41022		
	16	41023		
	18	41024		
	20	41025		
	22	41026		
25PK	12	42021	\$5.44	\$9.90
	14	42022		
	16	42023		
	18	42024		
	20	42025		
	22	42026		

TMC103BL



Down Eye, Extra Fine Wire, Wide Gape, Forged, Barbless, Black — *Dry Flies*

QUANTITY	SIZE	CODE	COST	SRP
25PK	13	42381	\$8.01	\$14.55
	15	42382		
	17	42383		
	19	42384		

HOOKS

TMC100SP-BL

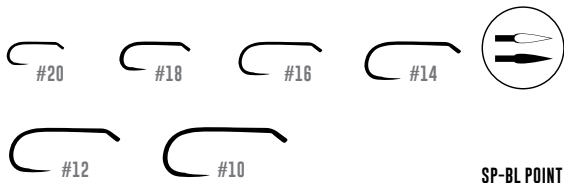

SP-BL POINT

Super Point, Straight, Down Eye, 1X Heavy, 1.5 Wide, Forged, Bronze, Barbless — *Dry Flies*

QUANTITY	SIZE	CODE	COST	SRP
100PK	10	41421	\$27.16	\$49.40
	12	41422		
	14	41423		
	16	41424		
	18	41425		
	20	41426		
25PK	10	42421	\$8.01	\$14.55
	12	42422		
	14	42423		
	16	42424		
	18	42425		
	20	42426		

TMC900BL

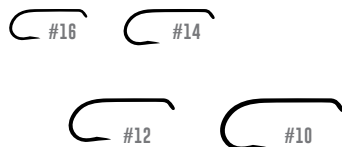

Down Eye, Extra Fine Wire, Wide Gape, Forged, Barbless, Black — *Dry Flies*

QUANTITY	SIZE	CODE	COST	SRP
25PK	10	42071	\$5.81	\$10.55
	12	42072		
	14	42073		
	16	42074		



- FLIES
- LEADER & TIPPET
- PACKS & BAGS
- ACCESSORIES
- HOOKS
- TOOLS & KITS
- TYING MATERIALS
- NECKS & SADDLES

NYMPH HOOKS

TMC200R

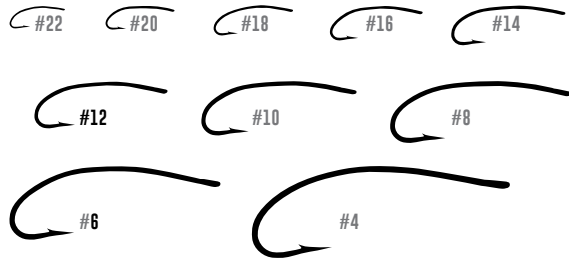

Straight Eye, Standard Wire, 3X Long, Semi-Dropped Point, Forged, Bronze — *Nymphs & Dry Flies*

QUANTITY	SIZE	CODE	COST	SRP
100PK	4	41501	\$21.56	\$39.20
	6	41502		
	8	41503		
	10	41504		
	12	41505		
	14	41506		
	16	41507		
	18	41508		
	20	41509		
	22	41510		
25PK	4	42501	\$6.34	\$11.55
	6	42502		
	8	42503		
	10	42504		
	12	42505		
	14	42506		
	16	42507		
	18	42508		
	20	42509		
	22	42510		

TMC2302



Slightly Humped Shank, Down Eye, Standard Wire, 2X Long, Forged, Bronze — *Caddis, Hoppers, Stoneflies & Terrestrials*

QUANTITY	SIZE	CODE	COST	SRP
25PK	6	42123	\$6.77	\$12.30
	8	42124		
	10	42125	\$6.34	\$11.55
	12	42126		
	14	42127		
	16	42128		

TMC2457



Down Eye, 2X Heavy, 2X Wide, 2X Short, Forged, Bronze — *Caddis Pupa & Shrimp*

QUANTITY	SIZE	CODE	COST	SRP
100PK	6	41116	\$22.92	\$41.75
	8	41117		
	10	41118	\$21.56	\$39.20
	12	41119		
	14	41120		
	16	41121		
	18	41122		
	25PK	6	42116	\$6.77
8		42117		
10		42118	\$6.34	\$11.55
12		42119		
14		42120		
16		42121		
18		42122		

HOOKS

TMC2487

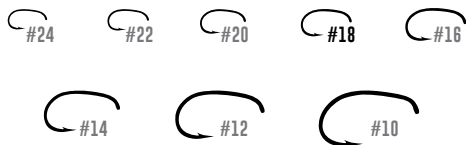

Down Eye, Fine Wire, 2X Wide, 2X Short, Forged, Bronze — *Caddis Pupa, Emergers & Shrimp*

QUANTITY	SIZE	CODE	COST	SRP
100PK	10	41130	\$18.95	\$34.45
	12	41131		
	14	41132		
	16	41133		
	18	41134		
	20	41135		
	22	41143		
	24	41129		
25PK	10	42130	\$5.58	\$10.15
	12	42131		
	14	42132		
	16	42133		
	18	42134		
	20	42135		
	22	42143		
	24	42129		

TMC2488



Straight Eye, 3X Wide, 2X Short, Curved Shank, Fine Wire, Bronze

QUANTITY	SIZE	CODE	COST	SRP
100PK	10	41165	\$20.34	\$37.00
	12	41166		
	14	41167		
	16	41168		
	18	41169		
	20	41170		
	22	41171		
	24	41172		
	26	41180		
	25PK	10	42165	\$5.97
12		42166		
14		42167		
16		42168		
18		42169		
20		42170		
22		42171		
24		42172		
26		42180		

TMC2488H



Nymph, Straight Eye, 3X Wide, 2X Short, Curved Shank, 2X Heavy, Forged, Bronze

QUANTITY	SIZE	CODE	COST	SRP
100PK	12	41185	\$22.27	\$40.50
	14	41186		
	16	41187		
	18	41188		
	20	41189		
	22	41190		
25PK	12	42185	\$6.54	\$11.90
	14	42186		
	16	42187		
	18	42188		
	20	42189		
	22	42190		

FLIES

LEADER & TIPPET

PACKS & BAGS

ACCESSORIES

HOOKS

TOOLS & KITS

TYING MATERIALS

NECKS & SADDLES

NYMPH HOOKS

TMC3761



Sproat Bend, Down Eye, 2X Heavy, 1X Long, Forged, Bronze — *Nymphs & Wet Flies*

QUANTITY	SIZE	CODE	COST	SRP
100PK	10	41145	\$18.69	\$34.00
	12	41146		
	14	41147		
	16	41148		
	18	41149		
25PK	6	42163	\$5.95	\$10.80
	8	42144		
	10	42145	\$5.47	\$9.95
	12	42146		
	14	42147		
	16	42148		
	20	42160		

TMC3769



Sproat Bend, Down Eye, 2X Heavy, Forged, Bronze — *Nymphs & Wet Flies*

QUANTITY	SIZE	CODE	COST	SRP
100PK	10	41138	\$18.78	\$34.15
	12	41139		
	14	41140		
	16	41141		
	18	41142		
25PK	6	42136	\$5.52	\$10.05
	8	42137		
	10	42138		
	12	42139		
	14	42140		
	18	42142		

TMC 413J



60 Degree Jig Hook, Wide Gape, Medium Wire, Bronze - Nymphs

QUANTITY	SIZE	CODE	COST	SRP
100PK	8	41430	\$31.75	\$57.75
	10	41431		
	12	41432		
	14	41433		
	16	41434		
	18	41435		
25PK	8	42430	\$9.35	\$17.00
	10	42431		
	12	42432		
	14	42433		
	16	42434		
	18	42435		

HOOKS

TMC5262

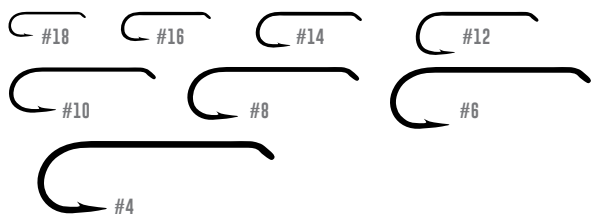

Perfect Bend, Down Eye 2X Long, Forged, Bronze — *Nymphs & Streamers*

QUANTITY	SIZE	CODE	COST	SRP
100PK	4	41200	\$24.42	\$44.40
	6	41201		
	8	41202		
	10	41203	\$21.56	\$39.20
	12	41204		
	14	41205		
	16	41206		
	18	41207		
25PK	4	42200	\$7.17	\$13.05
	6	42201		
	8	42202		
	10	42203	\$6.34	\$11.55
	12	42204		
	14	42205		
	16	42206		
	18	42207		

TMC5263

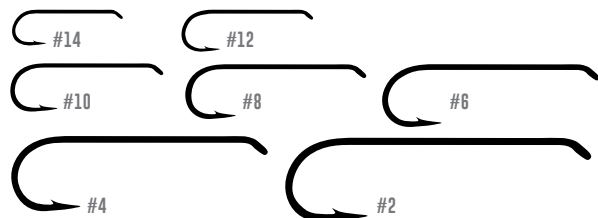

Perfect Bend, Down Eye, 2X Heavy, 3X Long, Forged, Bronze — *Nymphs & Streamers*

QUANTITY	SIZE	CODE	COST	SRP
100PK	2	41227	\$24.42	\$44.40
	4	41228		
	6	41229		
	8	41230		
	10	41231	\$21.56	\$39.20
	12	41232		
	14	41233		
	25PK	2	42227	\$7.17
4		42228		
6		42229		
8		42230		
10		42231	\$6.34	\$11.55
12		42232		
14		42233		

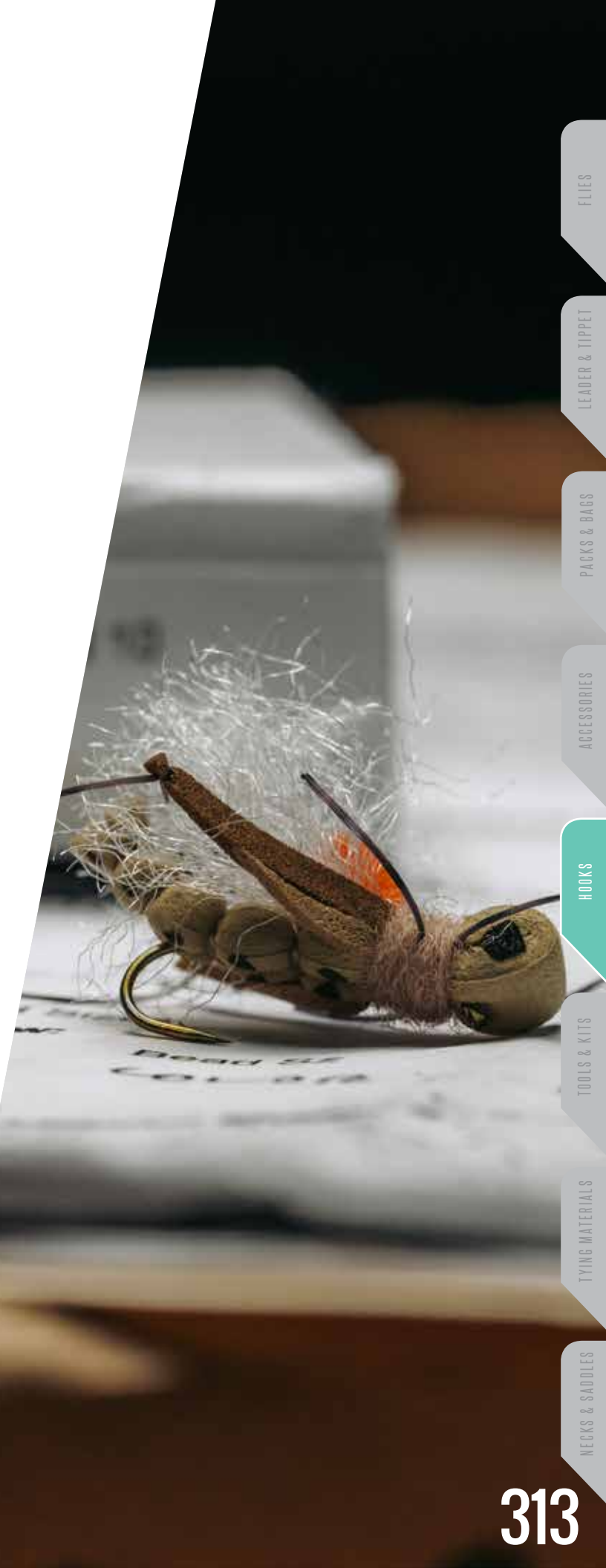

FLIES

LEADER & TIPPET

PACKS & BAGS

ACCESSORIES

HOOKS

TOOLS & KITS

TYING MATERIALS

NECKS & SADDLES

NYMPH HOOKS

BARBLESS

TMC206BL

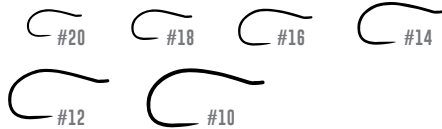

Curved Shank, Fine Wire, 2X Short, Forged, Super Fine, Super Fine Barbless Point, Black
— Caddis Larvae & Emergers

QUANTITY	SIZE	CODE	COST	SRP
25PK	10	42337	\$6.34	\$11.55
	12	42338		
	14	42339		
	16	42340		
	18	42341		
	20	42342		

TMC2499SP-BL

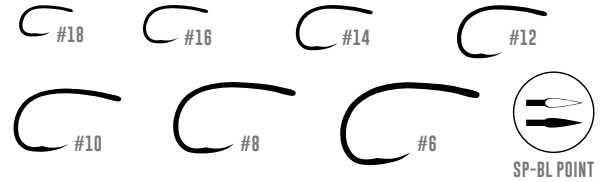

Super Point, Round, Straight Eye, 2X Heavy, 3X Wide, 2X Short, Curved Shank, Forged, Barbless, Bronze

QUANTITY	SIZE	CODE	COST	SRP
100PK	6	41440	\$31.75	\$57.75
	8	41441		
	10	41442		
	12	41443	\$30.36	\$55.20
	14	41444		
	16	41445		
	18	41446		
25PK	6	42440	\$9.35	\$17.00
	8	42441		
	10	42442		
	12	42443	\$8.92	\$16.20
	14	42444		
	16	42445		
	18	42446		

TMC2487BL



Down Eye, Fine Wire, 2X Wide, 2X Short, Forged, Barbless, Bronze
— Caddis Pupa, Emergers & Shrimp

QUANTITY	SIZE	CODE	COST	SRP
100PK	12	41588	\$18.95	\$34.45
	14	41589		
	16	41590		
	18	41591		
25PK	12	42588	\$5.58	\$10.15
	14	42589		
	16	42590		
	18	42591		

TMC403BLJ



60 Degree Jig Hook, Wide Gape, Medium Wire, Super Fine Barbless Point, Black

QUANTITY	SIZE	CODE	COST	SRP
100PK	8	41755	\$31.75	\$57.75
	10	41756		
	12	41757		
	14	41758		
	16	41759		
	18	41760		
25PK	8	42755	\$9.35	\$17.00
	10	42756		
	12	42757		
	14	42758		
	16	42759		
	18	42760		

TMC226BL



1XF, Up Eye, Organic Bend, Barbless, Bronze — Caddis/Emerger, Parachute

QUANTITY	SIZE	CODE	COST	SRP
25PK	8	42852	\$8.92	\$16.20
	10	42853		
	12	42854	\$8.01	\$14.55
	14	42855		
	16	42856		
	18	42857		
	20	42858		
	22	42859		

TMC3761SP-BL



SP-BL POINT

Super Point, Down Eye, 2X Heavy, 1X Long, Sproat Bend, Barbless, Bronze — Nymphs & Wet Flies

QUANTITY	SIZE	CODE	COST	SRP
25PK	12	42711	\$8.53	\$15.50
	14	42712		
	16	42713		

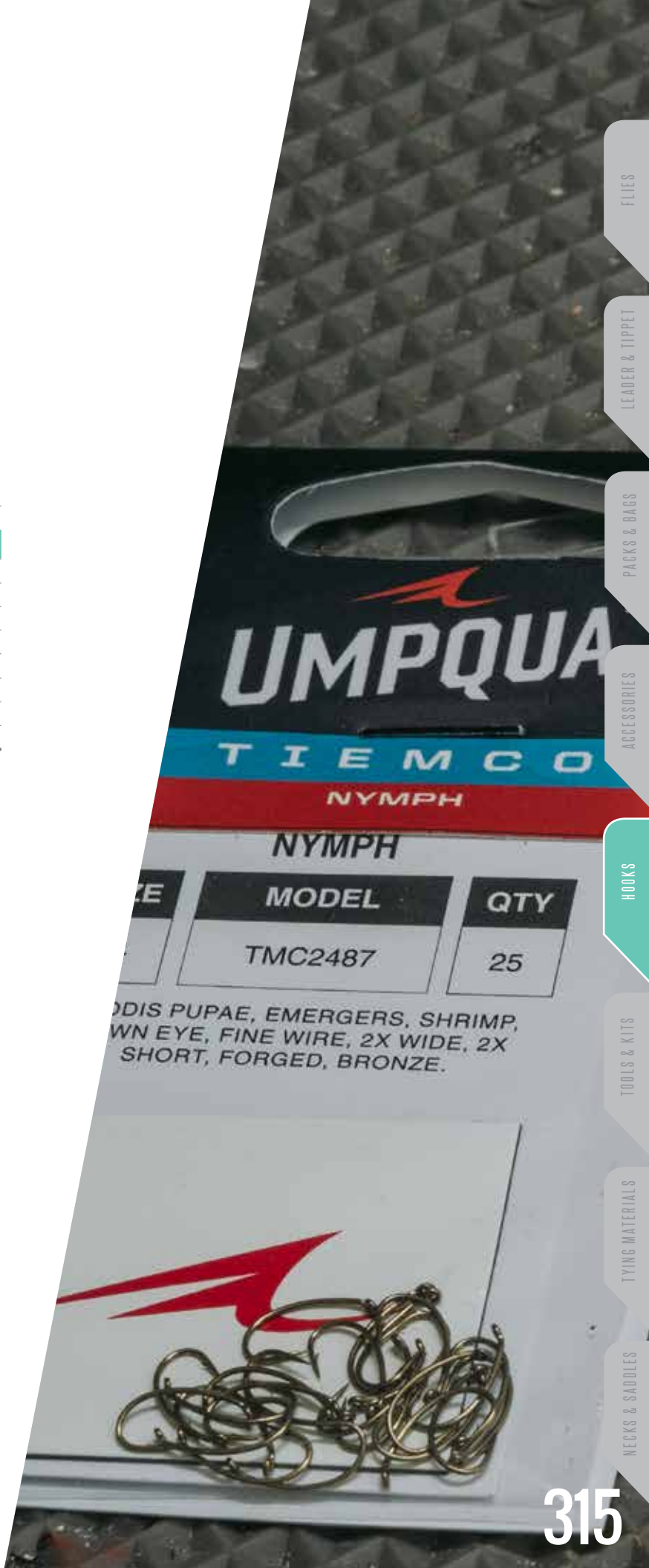

FLIES

LEADER & TIPPET

PACKS & BAGS

ACCESSORIES

HOOKS

TOOLS & KITS

TYING MATERIALS

NECKS & SADDLES

SALTWATER & SPECIALTY USE HOOKS

TMC600SP

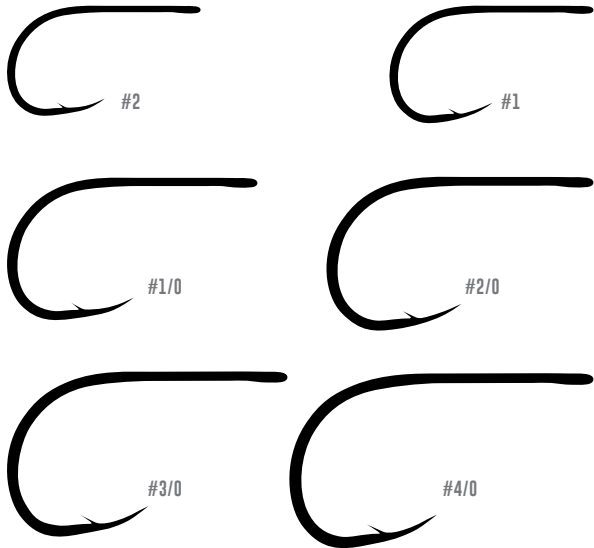

Super Point, 3XH, 2XS, 3XW, Forged, Black Nickel

QUANTITY	SIZE	CODE	COST	SRP
LARGE PACK				
22 PCS	4/0	47013	\$38.47	\$69.95
25 PCS	3/0	47012		
27 PCS	2/0	47011		
29 PCS	1/0	47010		
31 PCS	1	47008	\$35.38	\$64.35
31 PCS	2	47009		
SMALL PACK				
8 PCS	4/0	47003	\$16.28	\$29.60
9 PCS	3/0	47002		
10 PCS	2/0	47001		
12 PCS	1/0	47000	\$17.22	\$31.30
14 PCS	1	46998	\$18.78	\$34.15
14 PCS	2	46999		

TMC811S

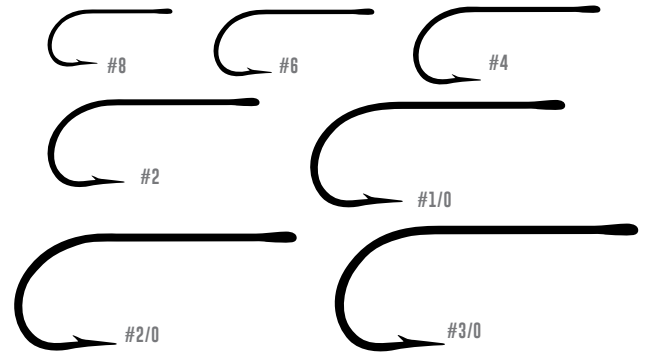

Straight Eye, Standard Length, Extra Strong, Forged, Stainless

QUANTITY	SIZE	CODE	COST	SRP
100PK	3/0	41667	\$64.53	\$117.35
	2/0	41668		
	1/0	41669		
	2	41671	\$57.30	\$104.20
	4	41672	\$46.08	\$83.80
	6	41673		
	8	41674		
25PK	3/0	42667	\$18.95	\$34.45
	2/0	42668		
	1/0	42669		
	2	42671	\$16.83	\$30.60
	4	42672	\$13.54	\$24.60
	6	42673		
	8	42674		

HOOKS

TMC105



Straight Eye, Reversed Bend. 2X Heavy, 5X Short, Forged, Bronze — *Egg Flies & Glow Bugs*

QUANTITY	SIZE	CODE	COST	SRP
25PK	4	42175	\$7.95	\$14.45
	6	42176	\$7.65	\$13.90
	8	42177	\$7.10	\$12.90
	10	42178	\$6.52	\$11.85

TMC800S

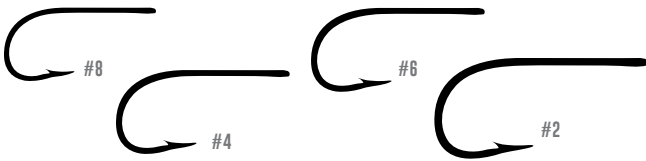

Straight Eye, Heavy Wire, Semi-Dropped Point, Forged, Stainless

QUANTITY	SIZE	CODE	COST	SRP
25PK	2	42634	\$13.54	\$24.60
	4	42635		
	6	42636		
	8	42637		

TMC8089

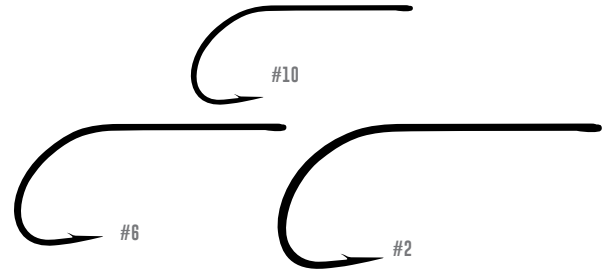

Straight Eye, Fine Wire, Wide Gape, Forged, Bronze. Bass Bugs

QUANTITY	SIZE	CODE	COST	SRP
25PK	2	42625	\$9.01	\$16.40
	6	42627	\$8.53	\$15.50
	10	42629	\$7.25	\$13.20

TMC8089NP



Same as TMC8089, Nickel Plated

QUANTITY	SIZE	CODE	COST	SRP
25PK	2	42660	\$9.01	\$16.40
	6	42661	\$8.53	\$15.50

FLIES

LEADER & TIPPET

PACKS & BAGS

ACCESSORIES

HOOKS

TOOLS & KITS

TYING MATERIALS

NECKS & SADDLES

STEELHEAD/ SALMON

TMC7999

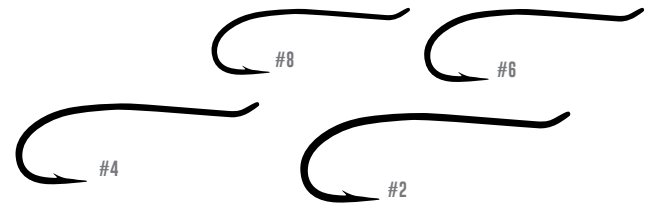

Upturned Tapered Loop-Eye, Heavy Wire, Forged, Black — *Steelhead & Salmon Flies, Dry Flies*

QUANTITY	SIZE	CODE	COST	SRP
25PK	2	42615	\$13.71	\$24.95
	4	42616	\$12.89	\$23.45
	6	42617		
	8	42618		

STREAMER HOOKS

TMC300

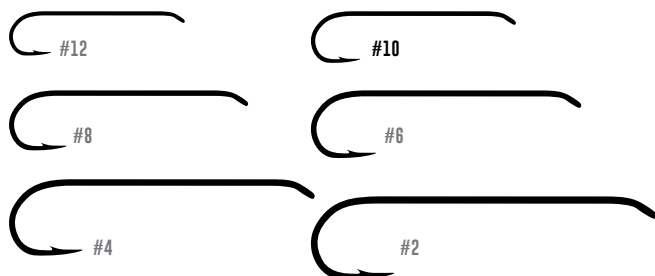

Down Eye, Heavy Wire, 6X Long, Forged, Bronze

QUANTITY	SIZE	CODE	COST	SRP
25PK	2	42526	\$7.33	\$13.35
	4	42527		
	6	42528		
	8	42529		
	10	42530		

TMC9395

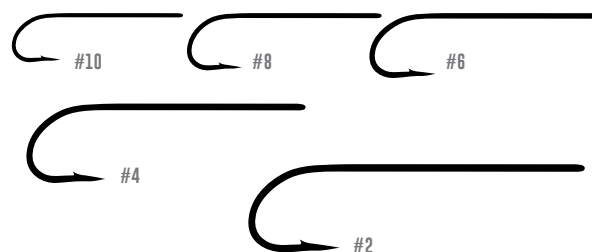

Straight Eye, 3X Heavy, 4X Long, Forged, Bronze

QUANTITY	SIZE	CODE	COST	SRP
25PK	2	42511	\$8.01	\$14.55
	4	42512		
	6	42513	\$7.25	\$13.20
	8	42514		
	10	42515		

TMC9394

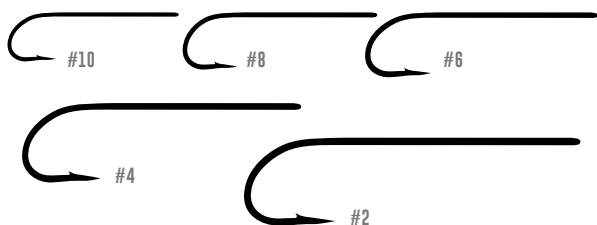

Straight Eye, 3X Heavy, 4X Long, Forged, Nickel Plated

QUANTITY	SIZE	CODE	COST	SRP
25PK	2	42516	\$8.01	\$14.55
	4	42517		
	6	42518	\$7.25	\$13.20
	8	42519		
	10	42520		

TMC708



40 Degree Keel/Jig Streamer, Variable Shank (3XL-1.5XL), 2X Heavy, Wide Gape, Forged, Bronze.

QUANTITY	SIZE	CODE	COST	SRP
25PK	6	42538	\$10.96	\$19.95
	8	42539		
	10	42540		

SUPER POINT SERIES

SUPER POINT SERIES

In addition to our outstanding, standard hook points, we are proud to offer the innovative Super Point Hook Series. This Super Point Series features a hollowed curve point with triangulated edges that sharpen easily. The “slow-tapered” point lowers the resistance of penetration, resulting in accelerated hook sets and better holding ability, especially in barbless versions.

To fit the needs of your customers, Tiemco® SP Hooks are available in a variety of popular models, including saltwater, streamer, dry and nymph hooks.

TMC100SP-BL

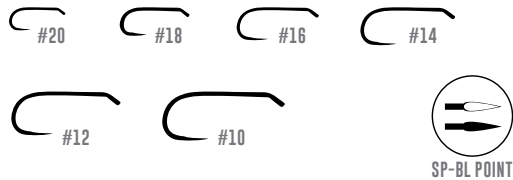

Super Point, Straight, Down Eye, 1X Heavy, 1.5 Wide, Forged, Barbless, Bronze — Dry Flies

QUANTITY	SIZE	CODE	COST	SRP
100PK	10	41421	\$27.16	\$49.40
	12	41422		
	14	41423		
	16	41424		
	18	41425		
	20	41426		
25PK	10	42421	\$8.01	\$14.45
	12	42422		
	14	42423		
	16	42424		
	18	42425		
	20	42426		

TMC2499SP-BL

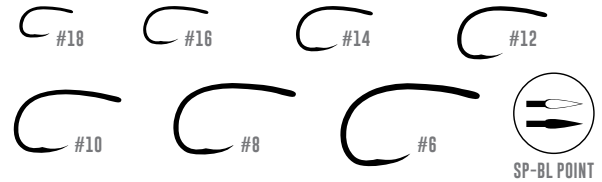

Super Point, Round, Straight Eye, 2X Heavy, 3X Wide, 2X Short, Curved Shank, Forged, Barbless, Bronze

QUANTITY	SIZE	CODE	COST	SRP
100PK	6	41440	\$31.75	\$57.75
	8	41441		
	10	41442		
	12	41443	\$30.36	\$55.20
	14	41444		
	16	41445		
	18	41446		
25PK	6	42440	\$9.35	\$17.00
	8	42441		
	10	42442		
	12	42443	\$8.92	\$16.20
	14	42444		
	16	42445		
	18	42446		

TMC2499SP-BLB

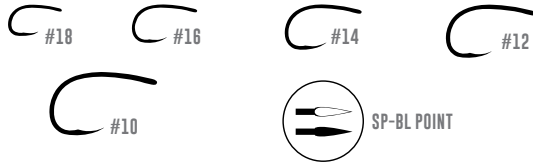

Super Point, Round, Straight Eye, 2X Heavy, 3X Wide, 2X Short, Curved Shank, Forged, Barbless, Black

QUANTITY	SIZE	CODE	COST	SRP
25PK	10	42735	\$9.35	\$17.00
	12	42736	\$8.92	\$16.20
	14	42737		
	16	42738		
	18	42739		

TMC3761SP-BL



Super Point, Down Eye, 2X Heavy, 1X Long, Sproat Bend, Barbless, Bronze — *Nymphs & Wet Flies*

QUANTITY	SIZE	CODE	COST	SRP
25PK	12	42711	\$8.28	\$15.05
	14	42712		
	16	42713		

TMC600SP

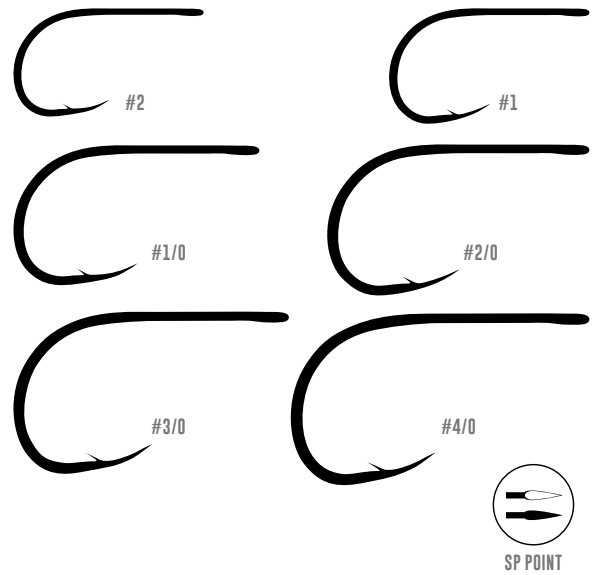

Super Point, 3XH, 2XS, 3XW, Forged, Black Nickel

QUANTITY	SIZE	CODE	COST	SRP
LARGE PACK				
22 PCS	4/0	47013	\$37.35	\$67.90
25 PCS	3/0	47012		
27 PCS	2/0	47011		
29 PCS	1/0	47010		
31 PCS	1	47008	\$34.35	\$62.45
31 PCS	2	47009		
SMALL PACK				
8 PCS	4/0	47003	\$15.81	\$28.75
9 PCS	3/0	47002		
10 PCS	2/0	47001		
12 PCS	1/0	47000	\$16.72	\$30.40
14 PCS	1	46998	\$18.23	\$33.15
14 PCS	2	46999		

PURE INNOVATION
THE ALL NEW X SERIES



X-SERIES HOOKS

COMPETITION/SPECIALTY

Fly fishing has evolved. Flies have become more specialized and so have the hooks they're tied on. Our new X-Series hooks represent the increasing styles of unique and specialized hooks customers need and demand. These models are hand-picked by our fly development team to assure we're leading the market with the most innovative and effective hooks and flies on the market.

X-Series Features

V-LOCK BEND – only available from Umpqua, the angular V shaped bend creates a “locking” angle after the hook penetrates past the barb, resulting in more landed fish.

Micro Barbs – the perfect balance of maximizing easy penetration and holding functionality. Combining micro-barbs with V-Lock design results in the best of both worlds

BN5X Finish – stands for “black nickel 5 times” meaning it provides extreme corrosion resistance along with an extremely smooth finish which improves hook penetration.

Forged Bend – compressing the steel wire at the bend (the location where most of the pressure/leverage is put on a hook) increases the density and strength of the steel resulting in a stronger hook

High Carbon Steel – because carbon enhances iron strength during the tempering process, the higher the carbon content, the stronger the hook and the sharper the point.

323

DRY FLY HOOKS

NEW

XC110BL-BN

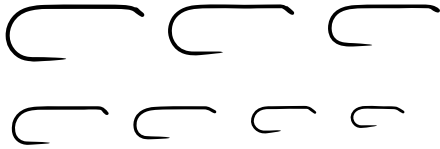

Standard Dry, Barbless, Down Eye, Straight Shank, 1XF, Wide Gape, Black Nickel

QUANTITY	SIZE	CODE	COST	SRP
25PK	08	47305	\$5.23	\$9.50
	10	47306		
	12	47307		
	14	47308		
	16	47309		
	18	47310		
	20	47311		

NEW

XC120BL-BN

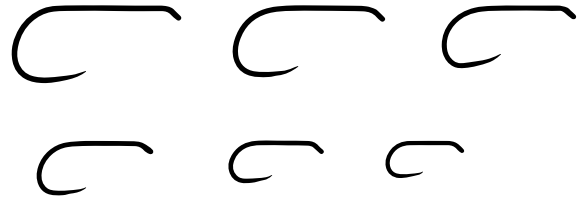

X-wide Gap Dry, Barbless, Down Eye, Straight Shank, 1XF, X-Wide Gape, Black Nickel

QUANTITY	SIZE	CODE	COST	SRP
25PK	10	47314	\$5.23	\$9.50
	12	47315		
	14	47316		
	16	47317		
	18	47318		
	20	47319		

NEW

XC130BL-BN

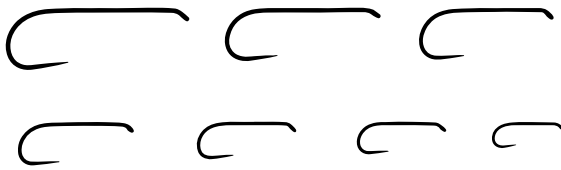

Long Shank Dry, Barbless, Down Eye, Straight/1X-Long Shank, 1XF, Black Nickel

QUANTITY	SIZE	CODE	COST	SRP
25PK	08	47322	\$5.23	\$9.50
	10	47323		
	12	47324		
	14	47325		
	16	47326		
	18	47327		
	20	47328		

NEW

XC220BL-BN

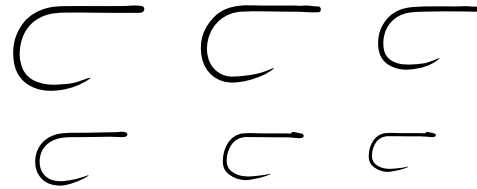

Dry/Nymph/Emerger Short Shank, Barbless, Straight Eye, Straight/X-Short Shank, X-Wide Gape, Black Nickel

QUANTITY	SIZE	CODE	COST	SRP
25PK	10	47331	\$5.23	\$9.50
	12	47332		
	14	47333		
	16	47334		
	18	47335		
	20	47336		

NEW

XC240BL-BN



Dry/Nymph/Emerger Curved Shank, Barbless, Curved Shank, X-Wide Gape, Black Nickel

QUANTITY	SIZE	CODE	COST	SRP
25PK	08	47339	\$5.23	\$9.50
	10	47340		
	12	47341		
	14	47342		
	16	47343		
	18	47344		
	20	47345		

X- SERIES HOOKS

XC-COMPETITION HOOKS

With the Competition Series, Umpqua offers the models the best fly fishermen in the world use and trust. Designed in cooperation with individual and team world champions, these high carbon steel fly hooks have large gapes for superior hooking, black nickel finish for increased stealth, and barbless extra-long needle points to hold fish with minimal impact.

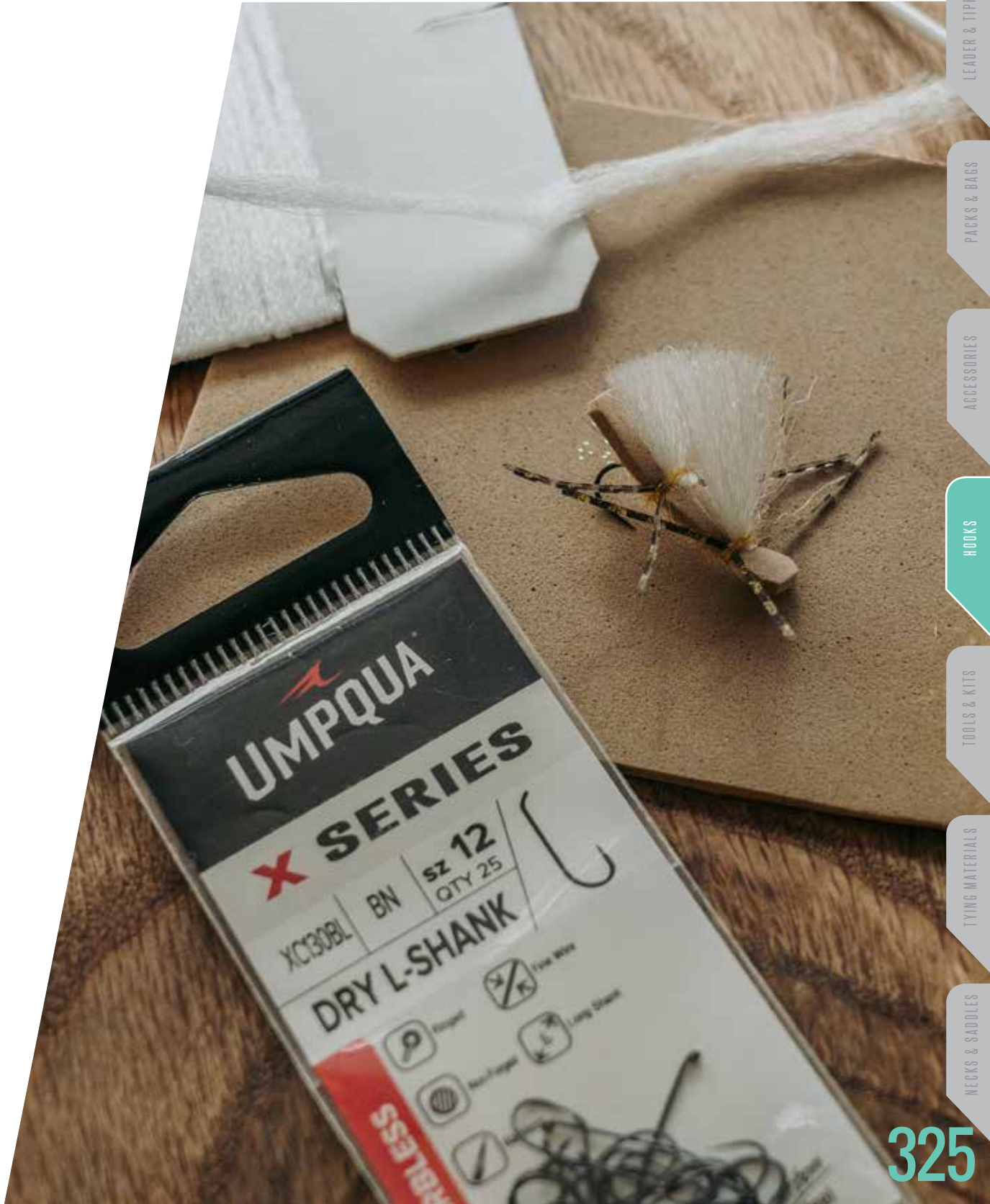

FLIES

LEADER & TIPPET

PACKS & BAGS

ACCESSORIES

HOOKS

TOOLS & KITS

TYING MATERIALS

NECKS & SADDLES

NYMPH HOOKS

COMPETITION HOOKS

XC-COMPETITION HOOKS

With the Competition Series, Umpqua offers the models the best fly fishermen in the world use and trust. Designed in cooperation with individual and team world champions, these high carbon steel fly hooks have large gapes for superior hooking, black nickel finish for increased stealth, and barbless extra-long needle points to hold fish with minimal impact.

XC210BL-BN

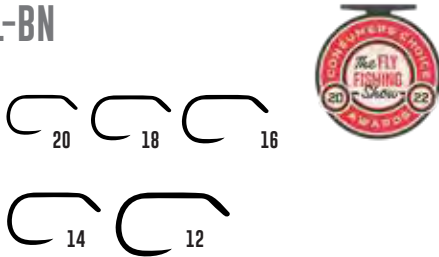

1x Short, 3x Mega-Gape, 1x Heavy, PerdiJig Hook

QUANTITY	SIZE	CODE	COST	SRP
25PK	12	47190	\$5.23	\$9.50
	14	47191		
	16	47192		
	18	47193		
	20	47194		

XC290BL-BN

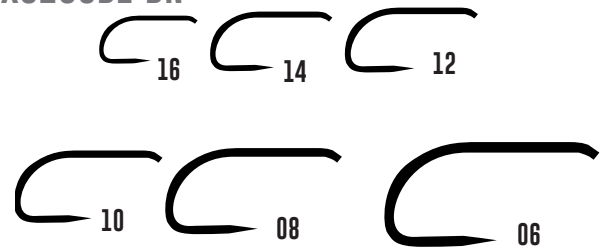

Streamer, Wet- Barbless, Heavy, Wide gape, Extended point, DE, Limerick bend, BN finish

QUANTITY	SIZE	CODE	COST	SRP
25PK	06	47200	\$5.23	\$9.50
	08	47201		
	10	47202		
	12	47203		
	14	47204		
	16	47205		

XC400BL-BN

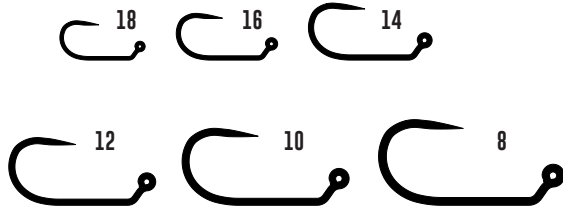

Nymph Super- Barbless, 60 Degree jig, Heavy, Wide gape, XL Needle point, BN finish

QUANTITY	SIZE	CODE	COST	SRP
25PK	08	47210	\$5.23	\$9.50
	10	47211		
	12	47212		
	14	47213		
	16	47214		
	18	47215		

XC450BL-BN



Super-Gap Jig- Barbless, 60 Degree jig, Heavy, XX Wide gape, XL Needle point, BN finish

QUANTITY	SIZE	CODE	COST	SRP
25PK	10	47230	\$5.23	\$9.50
	12	47231		
	14	47232		
	16	47233		
	18	47234		

X-SERIES HOOKS



FLIES

LEADER & TIPPET

PACKS & BAGS

ACCESSORIES

HOOKS

TOOLS & KITS

TYING MATERIALS

NECKS & SADDLES

XC2

DR

SALTWATER HOOKS

XS410 NI5X

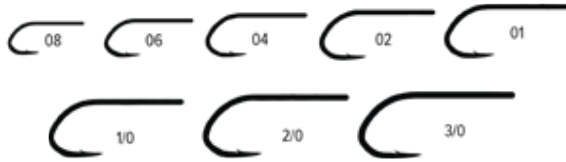

ALL PURPOSE SALTWATER

Straight eye, wide gap, variable length, X-Strong, forged bend, V-Lock bend, micro-barb, BN5X finish.

Simplify your salt, big-game and flats tying with this great all-around hook. With variable shank length and wire strength (optimized for size), this hook is perfect for flats flies in sizes 2-10 (Gotchas, etc.), 1/0-2 permit flies (crab patterns), and baitfish up to 4/0 (i.e. Deceivers)

QUANTITY	SIZE	CODE	COST	SRP
10PK	3/0	47121	\$6.79	\$12.35
12PK	2/0	47122		
15PK	1/0	47123		
20PK	01	47124		
	02	47125		
	04	47126		
	06	47127		
	08	47128		

XS415 BN5X

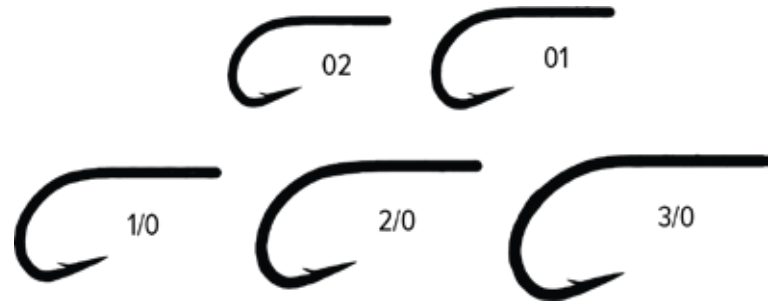

SALTWATER BACKCOUNTRY

Hook and hold the toughest of saltwater fish. While specifically designed for Tarpon, this is a great all-around saltwater hook (think Deceivers and Clousers) that consistently gets big fish to the net. A large gap, sticky point and special BN5X finish put this hook above the competition. Only from Umpqua, the BN5X black nickel finish is up to 5X more corrosion resistant than standard BN finishes.

Straight Eye, Wide Gape, Extra Strong, Needle Point, BN5X finish (super corrosion-resistant black nickel)

QUANTITY	SIZE	CODE	COST	SRP
10PK	3/0	47170	\$6.16	\$11.20
12PK	2/0	47171		
15PK	1/0	47172		
20PK	01	47173		
	02	47174		

XS415H BN5X

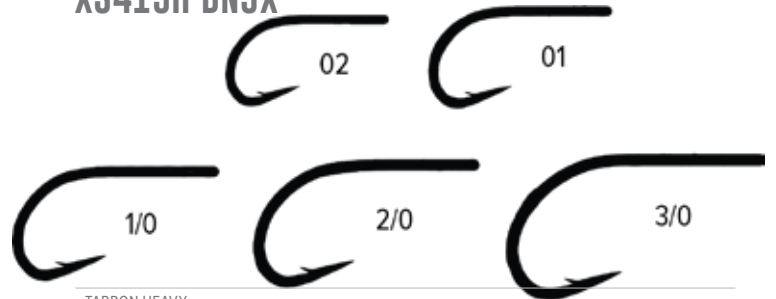

TARPON HEAVY

Straight eye, wide gap, X-heavy, forged bend, micro-barb, BN5X finish

A heavy-duty forged bend and extra-strong wire result in a hook you can trust when chasing big tarpon. A micro-barb, smooth BN5X finish and unique bend/point configuration result in easy penetration and reliable hold.

QUANTITY	SIZE	CODE	COST	SRP
10PK	3/0	47100	\$6.79	\$12.35
12PK	2/0	47101		
15PK	1/0	47102		
20PK	01	47103		
	02	47104		

X- SERIES HOOKS

XS420 BN5X

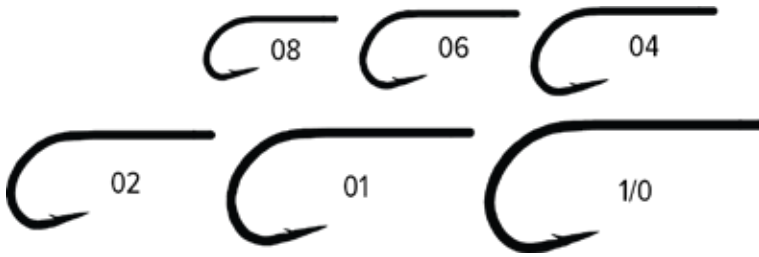

SALTWATER FLATS

A new standard for flats flies, the XS420 is the ideal hook to update and improve your version of any Gotcha, Charlie, Scampi, etc.. A unique bend holds fish like a vise and our proprietary BN5X finish (up to 5x more corrosion resistant than standard black nickel) sets this hook apart. Only from Umpqua, the BN5X black nickel finish is up to 5X more corrosion resistant than standard BN finishes.

Straight Eye, Standard Length, Extra Strong, Needle Point, BN5X finish (super corrosion-resistant black nickel)

QUANTITY	SIZE	CODE	COST	SRP
15PK	1/0	47110	\$8.20	\$14.90
20PK	01	47111		
	02	47112		
	04	47113		
	06	47114		
	08	47115		
	10	47116		

XS435 BN5X BENDBACK

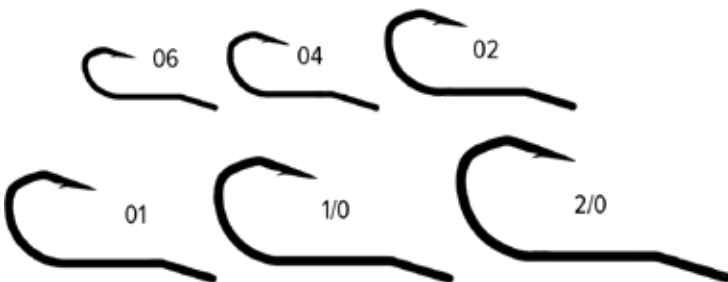

BENDBACK

Bendback, straight eye, strong, forged bend, micro-barb, V-Lock bend, BN5X

We believe the Bendback deserves a long overdue comeback! Baitfish and shrimp patterns tied on the XS435 are naturally weedless without the typical compromise in gap. The V-Lock bend results in hook holding never before available in this style.

QUANTITY	SIZE	CODE	COST	SRP
12PK	2/0	47144	\$8.20	\$14.90
15PK	1/0	47145		
20PK	01	47146		
	02	47147		
	04	47148		
	06	47149		

XS425 BN5X

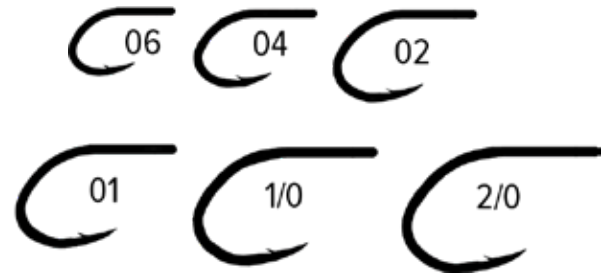

BAITFISH / STINGER

Stinger, straight eye, wide gap, forged bend, micro-barb, V-Lock bend, BN5X

The XS425's combination of short shank, wide gap and V-Lock bend make for an incredible fish-holding hook. Perfect for any short-shank minnow/baitfish/streamer patterns.

QUANTITY	SIZE	CODE	COST	SRP
12 PK	2/0	47130	\$6.16	\$11.20
15 PK	1/0	47131		
20 PK	01	47132		
	02	47133		
	04	47134		
	06	47135		

XS425 RN5X (RED)

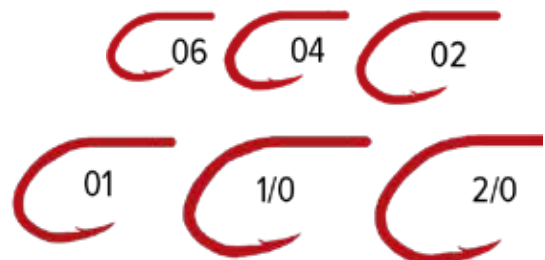

BAITFISH / STINGER

Stinger, straight eye, wide gap, forged bend, micro-barb, V-Lock bend, RN5X

The XS425's combination of short shank, wide gap and V-Lock bend make for an incredible fish-holding hook. Perfect for any short-shank minnow/baitfish/streamer patterns.

QUANTITY	SIZE	CODE	COST	SRP
12 PK	2/0	47136	\$5.42	\$9.85
15 PK	1/0	47137		
20 PK	01	47138		
	02	47139		
	04	47140		
	06	47141		

FLIES

LEADER & TIPPET

PACKS & BAGS

ACCESSORIES

HOOKS

TOOLS & KITS

TYING MATERIALS

NECKS & SADDLES

SALTWATER HOOKS

XBG580 BLACK BEAST

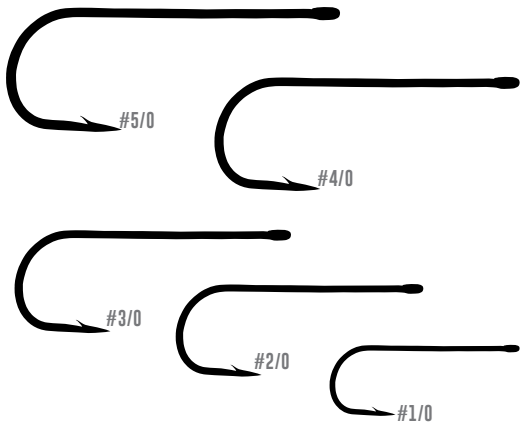

BEAST HOOK

Straight eye, heavy wire, round bend, forged bend, black nickel

Big flies for big fish require a big hook. The XBG580 name pretty much says it all...BEAST!

QUANTITY	SIZE	CODE	COST	SRP
10PK	5/0	47034	\$7.48	\$13.60
	4/0	47033		
	3/0	47032		
12PK	2/0	47031		
15PK	1/0	47030		

XS506 JIG

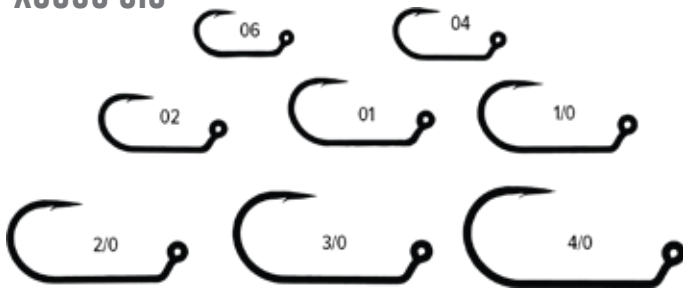

60 DEGREE JIG

Strong, micro-barb, black nickel

A great all-purpose 60 degree jig hook ideal for larger freshwater fish (think streamers & carp flies) and saltwater bottom feeding fish (i.e. bonefish & redfish). The 60 degree jig results in a great up/down "jigging" motion that consistently triggers eats and greatly improves straight "tracking".

* Image not to scale.

QUANTITY	SIZE	CODE	COST	SRP
10PK	4/0	47160	\$6.79	\$12.35
	3/0	47161		
	2/0	47162		
15PK	1/0	47163		
20PK	01	47164		
	02	47165		
	04	47166		
	06	47167		

X- SERIES HOOKS

TROUT HOOKS

XS506H JIG

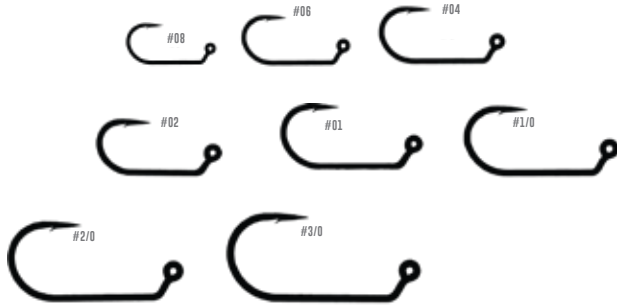

60 DEGREE JIG / EXTRA STRONG
Micro-barb, black nickel

Enhance the effectiveness of your big baitfish/streamer patterns as well as any permit crab/shrimp with the beefy jig hook. The 60 degree jig results in a great up/down "jigging" motion that consistently triggers eats and greatly improves straight "tracking".

*Image not to scale

QUANTITY	SIZE	CODE	COST	SRP
10PK	3/0	47150	\$7.48	\$13.60
12PK	2/0	47151		
15PK	1/0	47152		
20PK	01	47153		
	02	47154		
	04	47155		
	06	47156		
	08	47157		

XT500 BN JIG

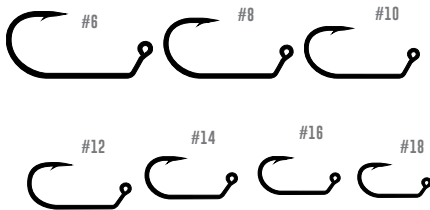

60 DEGREE JIG

Finally, a high quality, barbed jig hook for all of your nymph patterns. A 60 degree jig minimizes snagging and a 1x long shank gives the perfect amount of room for the most important nymph patterns. A low profile barb makes for excellent penetration and easy de-barbing.

60 Degree Jig, 1X Heavy, Micro Barb, Black Nickel

QUANTITY	SIZE	CODE	COST	SRP
25PK	6	47060	\$5.23	\$9.50
	8	47061		
	10	47062		
	12	47063		
	14	47064		
	16	47065		
	18	47066		

XT050 STUBBY T



Now you can tie your favorite foam terrestrials and bushy dries smaller without sacrificing gap. Great for "stubby" Chubbies and any high-floating dry fly. New V-Lock bend will ensure you hold them after the inevitable eat.

Down eye, 1/2X heavy, Wide Gap, Forged bend, micro-barb, V-Lock bend, BN5X finish

QUANTITY	SIZE	CODE	COST	SRP
25PK	10	47049	\$5.23	\$9.50
	12	47050		
	14	47051		
	16	47052		
	18	47053		

FLIES

LEADER & TIPPET

PACKS & BAGS

ACCESSORIES

HOOKS

TOOLS & KITS

TYING MATERIALS

NECKS & SADDLES



U-SERIES HOOKS



A quality product at a terrific price.

UMPQUA offers the serious fly tier a value-based hook alternative to the current offerings on the market, with a broad range of the most desirable hook styles. After extensive product research, we deliver a quality product at a terrific price. Umpqua U-series hooks feature; high grade carbon steel, chemically sharpened points, micro barbs for easy penetration and easy de-barbing, along with a logical numbering system for hook use identification.

U0XX — DRY FLY HOOKS

U1XX — NYMPH HOOKS

U2XX — CURVED HOOKS

U3XX — STREAMER HOOKS

U4XX — SALTWATER HOOKS

U5XX — SPECIALTY HOOKS

U6XX — COMPETITION HOOKS

333

DRY FLY HOOKS

U001

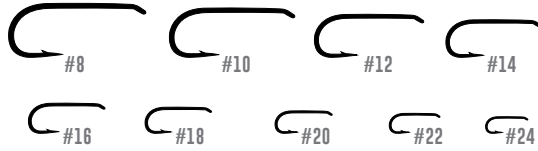

Standard Wire, Down Eye, 1X Long, Bronze — Dry Flies

QUANTITY	SIZE	CODE	COST	SRP
50PK	8	45001	\$4.18	\$7.60
	10	45002		
	12	45003		
	14	45004		
	16	45005		
	18	45006		
	20	45007		
	22	45008		
	24	45009		

U002

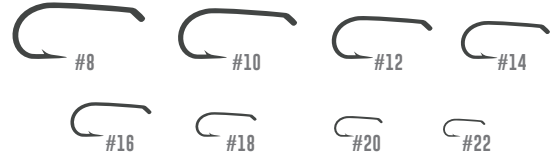

Standard Wire, Down Eye — Dry Flies

QUANTITY	SIZE	CODE	COST	SRP
50PK	8	45011	\$4.18	\$7.60
	10	45012		
	12	45013		
	14	45014		
	16	45015		
	18	45016		
	20	45017		
	22	45018		

U003



Standard Wire, Straight Eye — Dry Flies

QUANTITY	SIZE	CODE	COST	SRP
50 PK	16	45020	\$4.18	\$7.60
	18	45021		
	20	45022		
	22	45023		

U- SERIES HOOKS



FLIES

LEADER & TIPPET

PACKS & BAGS

ACCESSORIES

HOOKS

TOOLS & KITS

TYING MATERIALS

NECKS & SADDLES

NYMPH HOOKS

U101

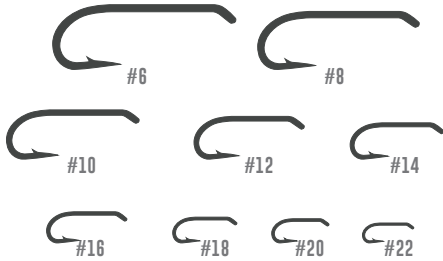

Sproat, 1X Long, 1X Strong — Nymphs

QUANTITY	SIZE	CODE	COST	SRP
50PK	6	45101	\$4.95	\$9.00
	8	45102		
	10	45103		
	12	45104		
	14	45105		
	16	45106		
	18	45107		
	20	45108		
	22	45109		

U103

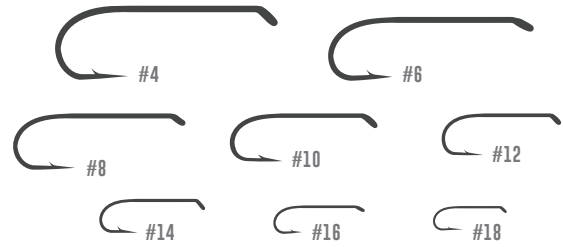

1X Strong Wire, 2XL — Nymphs & Streamers

QUANTITY	SIZE	CODE	COST	SRP
50PK	4	45120	\$5.53	\$10.05
	6	45121		
	8	45122		
	10	45123	\$4.95	\$9.00
	12	45124		
	14	45125		
	16	45126		
	18	45127		

U102

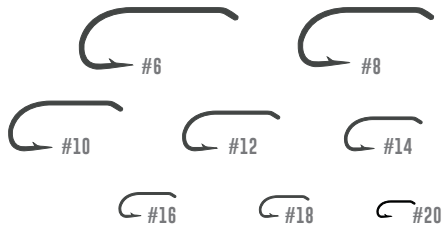

1X Fine Wire, Sproat — Wet Flies & Nymphs

QUANTITY	SIZE	CODE	COST	SRP
50PK	6	45111	\$4.73	\$8.60
	8	45112		
	10	45113		
	12	45114		
	14	45115		
	16	45116		
	18	45117		
	20	45118		

U104

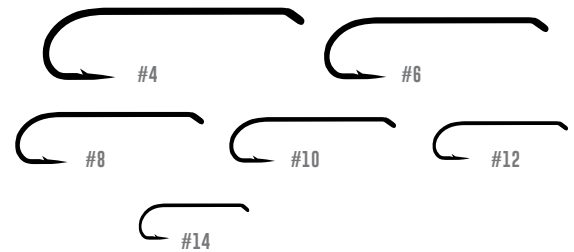

Down Eye, Standard Wire, 3X Long, Sproat Bend, Bronze — Nymphs & Streamers

QUANTITY	SIZE	CODE	COST	SRP
50PK	4	45129	\$5.64	\$10.25
	6	45130		
	8	45131		
	10	45132	\$4.73	\$8.60
	12	45133		
	14	45134		

U- SERIES HOOKS

U105



Down Eye, 2X Strong Wire, 1X Short, Sproat Bend, Bronze — *Nymphs & Wet Flies*

QUANTITY	SIZE	CODE	COST	SRP
50PK	10	45143	\$4.37	\$7.95
	12	45144		
	14	45145		
	16	45146		
	18	45147		
	20	45148		

U106



Down Eye, 1X Strong Wire, 4X Long, Round Bend, Bronze — *Nymphs & Streamers*

QUANTITY	SIZE	CODE	COST	SRP
50PK	4	45151	\$8.91	\$16.20
	6	45152	\$7.18	\$13.05
	8	45153		
	10	45154	\$4.95	\$9.00
	12	45155		

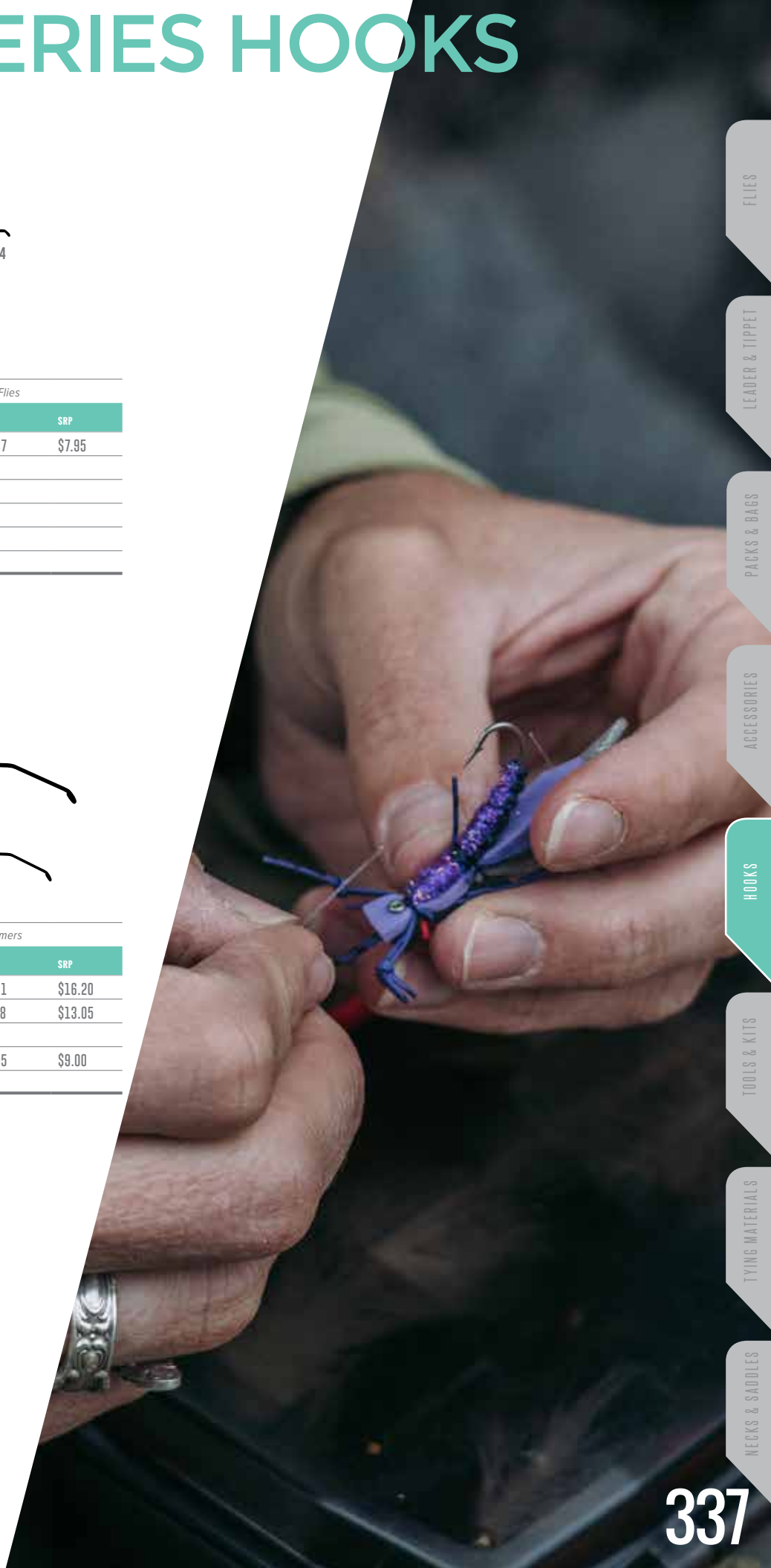

FLIES

LEADER & TIPPET

PACKS & BAGS

ACCESSORIES

HOOKS

TOOLS & KITS

TYING MATERIALS

NECKS & SADDLES

CURVED HOOKS

U201



Curved, Straight Eye, 2X Short, Reversed Bend

QUANTITY	SIZE	CODE	COST	SRP
50PK	12	45201	\$4.73	\$8.60
	14	45202		
	16	45203		
	18	45204		
	20	45205		
	22	45206		
	24	45207		

U202

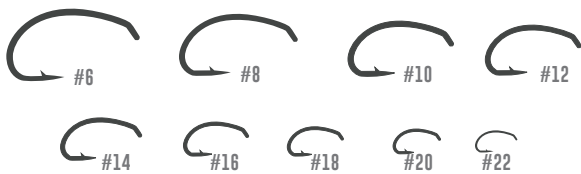

Curved, 1X Short, 1X Strong, Bronze — *Worms, Scuds, Eggs, Caddis Pupae*

QUANTITY	SIZE	CODE	COST	SRP
50PK	6	45209	\$4.73	\$8.60
	8	45210		
	10	45211		
	12	45212		
	14	45213		
	16	45214		
	18	45215		
	20	45216		
	22	45217		

U202RED

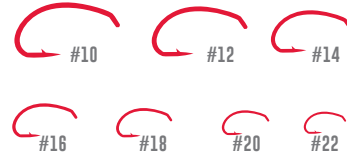

— *Worms, Scuds, Eggs, Caddis Pupae*

QUANTITY	SIZE	CODE	COST	SRP
50PK	10	45846	\$5.89	\$10.70
	12	45847		
	14	45848		
	16	45849		
	18	45850		
	20	45851		
	22	45852		

U203

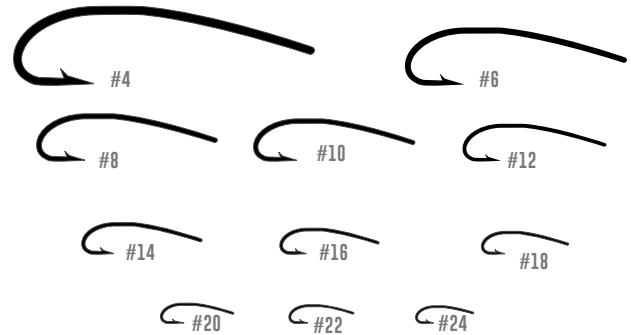

Curved, Straight Eye, 3X Long, Bronze — *Streamers, Leeches, Stonefly Nymphs and Worms*

QUANTITY	SIZE	CODE	COST	SRP
50PK	4	45219	\$5.64	\$10.25
	6	45220		
	8	45221	\$4.73	\$8.60
	10	45222		
	12	45223		
	14	45224		
	16	45225		
	18	45226		
	20	45227		
	22	45228		
	24	45229		

U- SERIES HOOKS

U204

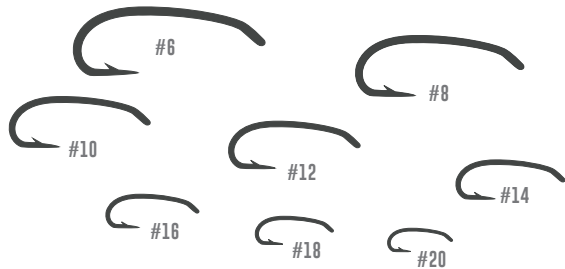

Curved, Down Eye, 2XL

QUANTITY	SIZE	CODE	COST	SRP
50PK	6	45231	\$4.73	\$8.60
	8	45232		
	10	45233		
	12	45234		
	14	45235		
	16	45236		
	18	45237		
	20	45238		

U205



Down Eye, Heavy Wire, 3X Long, Bronze

QUANTITY	SIZE	CODE	COST	SRP
50PK	8	45241	\$4.95	\$9.00
	10	45242		
	12	45243		
	14	45244		
	16	45245		
	18	45246		



FLIES

LEADER & TIPPET

PACKS & BAGS

ACCESSORIES

HOOKS

TOOLS & KITS

TYING MATERIALS

NECKS & SADDLES

STREAMER & SALTWATER HOOKS

U301

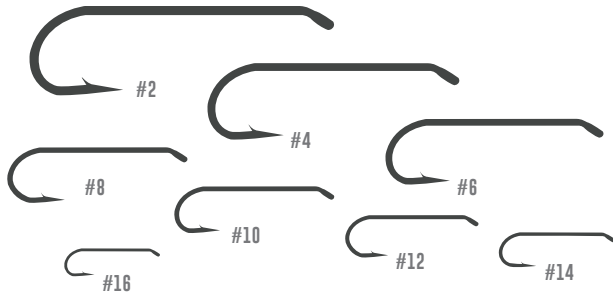

Streamer, Down Eye, 1X Strong, 3X Long, Bronze

QUANTITY	SIZE	CODE	COST	SRP
50PK	2	45301	\$6.99	\$12.70
	4	45302		
	6	45303		
	8	45304	\$5.03	\$9.15
	10	45305		
	12	45306		
	14	45307		
	16	45308		

U401

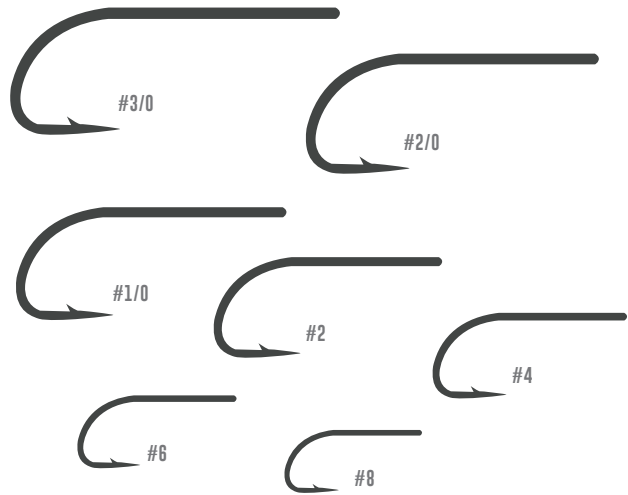

Saltwater/Stainless, Straight Eye, 1X Strong

QUANTITY	SIZE	CODE	COST	SRP
25PK	3/0	45401	\$7.45	\$13.55
	2/0	45402		
	1/0	45403		
	2	45404	\$4.90	\$8.90
	4	45405		
	6	45406		
	8	45407		

U302

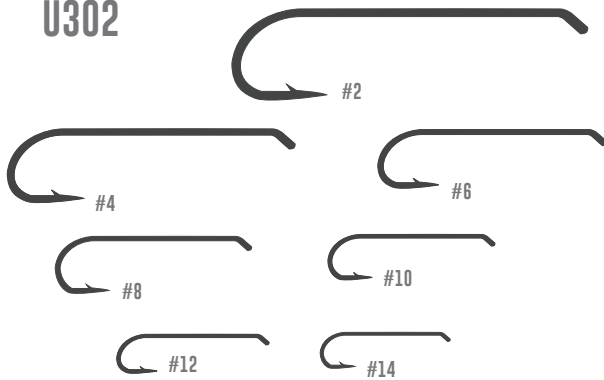

Streamer, Down Eye, 1X Strong, 4XL

QUANTITY	SIZE	CODE	COST	SRP
50PK	2	45310	\$6.99	\$12.70
	4	45311		
	6	45312		
	8	45313	\$4.95	\$9.00
	10	45314		
	12	45315		
	14	45316		

U- SERIES HOOKS

SPECIALTY HOOKS

U501



Egg, Straight Eye, 2X Strong, 5X Short

QUANTITY	SIZE	CODE	COST	SRP
50PK	6	45501	\$4.95	\$9.00
	8	45502		
	10	45503		

U502

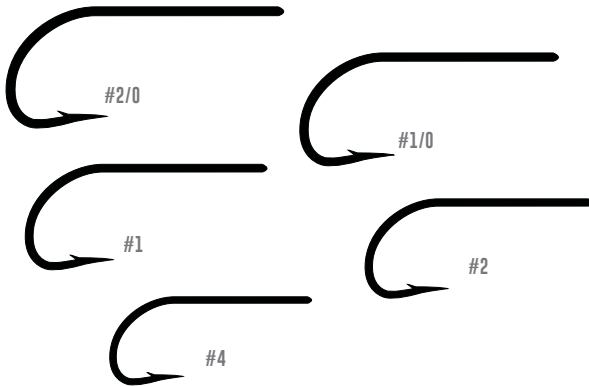

Straight Eye, 1X Strong — Bass

QUANTITY	SIZE	CODE	COST	SRP
25PK	2/0	45505	\$7.18	\$13.05
	1/0	45506		
	1	45507	\$4.90	\$8.90
	2	45508		
	4	45509		

U503

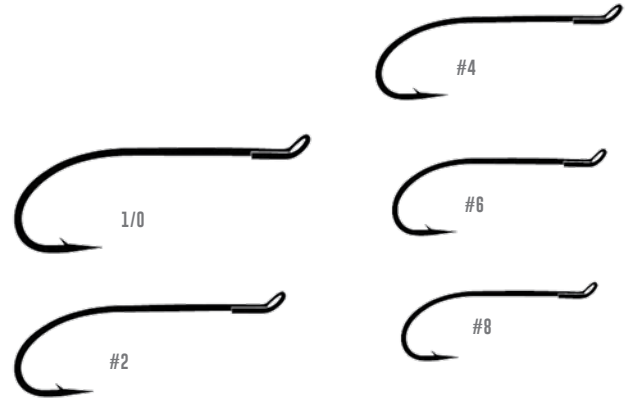

Salmon/Steelhead, Turned Up Loop Eye, Heavy Wire, Salmon Bend, Black

QUANTITY	SIZE	CODE	COST	SRP
25PK	1/0	45512	\$8.77	\$15.95
	2	45513	\$7.56	\$13.75
	4	45514	\$6.77	\$12.30
	6	45515	\$5.89	\$10.70
	8	45516	\$5.53	\$10.05

U504

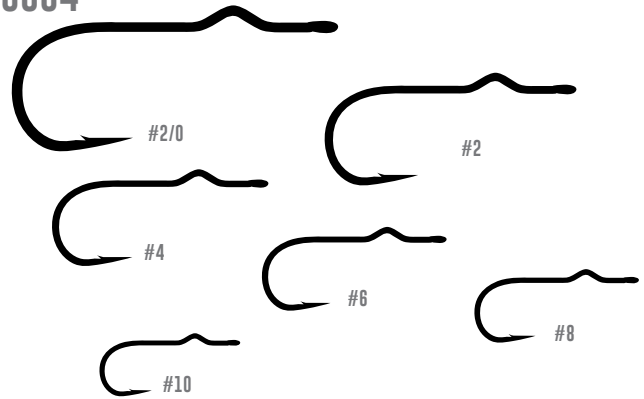

Popper Hook, Standard Wire, 2X Long, Kink Shank, Bronze

QUANTITY	SIZE	CODE	COST	SRP
25PK	2/0	45518	\$9.74	\$17.70
	2	45519	\$6.44	\$11.70
50PK	4	45520	\$8.42	\$15.30
	6	45521	\$8.22	\$14.95
	8	45522	\$8.22	\$14.95
	10	45523	\$8.03	\$14.60

FLIES

LEADER & TIPPET

PACKS & BAGS

ACCESSORIES

HOOKS

TOOLS & KITS

TYING MATERIALS

NECKS & SADDLES

SPECIALTY HOOKS & SHANKS

U505

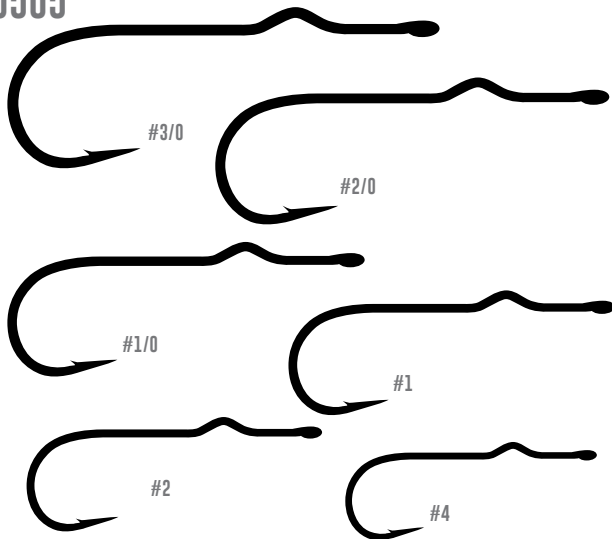

Saltwater Popper Hook, 2X Heavy, 4X Long, Kink Shank, Stainless

QUANTITY	SIZE	CODE	COST	SRP
25PK	3/0	45526	\$8.42	\$15.30
	2/0	45527	\$8.42	\$15.30
	1/0	45528	\$7.89	\$14.35
	1	45529	\$7.51	\$13.65
	2	45530	\$7.29	\$13.25
	4	45531	\$7.29	\$13.25

U555

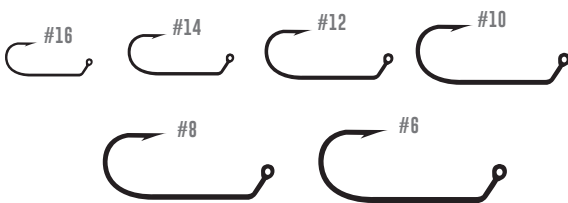

60 Degree Jig, Straight, Medium Wire, Bronze

QUANTITY	SIZE	CODE	COST	SRP
50PK	6	45684	\$8.09	\$14.70
	8	45685		
	10	45686		
	12	45687		
	14	45688		
	16	45689		

TROUT SHANKS

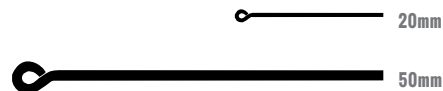

Standard Wire, Straight Eye, Shank, Bronze — Articulated Trout Flies

QUANTITY	SIZE	CODE	COST	SRP
25PK	20MM	45544	\$5.28	\$9.60
	50MM	45545		

WADDINGTON SHANK

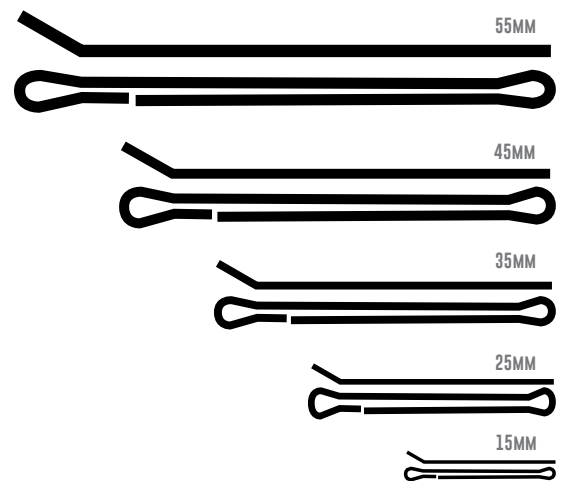

Stainless, Heavy Wire, Double Shank, Up-Turn Leading Eye
— Salmon/Steelhead, Saltwater, Articulated Streamer

QUANTITY	SIZE	CODE	COST	SRP
25PK	55MM	45543	\$7.43	\$13.50
	45MM	45542		
	35MM	45541		
	25MM	45540		
	15MM	45539		

U- SERIES HOOKS



FLIES

LEADER & TIPPET

PACKS & BAGS

ACCESSORIES

HOOKS

TOOLS & KITS

TYING MATERIALS

NECKS & SADDLES

COMPETITION HOOKS

Our collection of UC competition hooks offer up an unbeatable value for tyers who are looking for shapes that hook and hold fish. This collection has a hook for every type of fly that you can dream up. As a reminder these great hooks come in a 50 pack.

UC600BL-BN

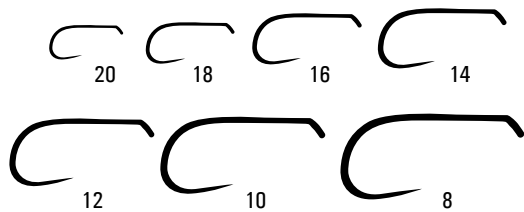

Dry Flies- Barbless, Standard wire, Wide gape, Straight shank, Up-turned point, DE, Black Nickel

QUANTITY	SIZE	CODE	COST	SRP
50PK	8	47257	\$7.07	\$12.85
	10	47258		
	12	47259		
	14	47260		
	16	47261		
	18	47262		
	20	47263		

UC608BL-BN

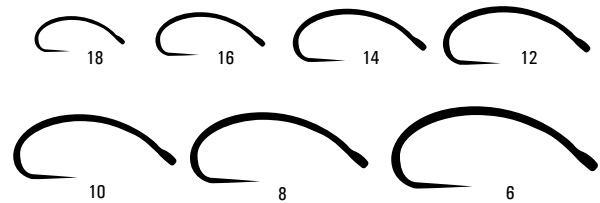

Stonefly, Caddis- Barbless, 1X Heavy, Curved, 2X Long, Straight eye, Black Nickel

QUANTITY	SIZE	CODE	COST	SRP
50PK	6	47264	\$7.07	\$12.85
	8	47265		
	10	47266		
	12	47267		
	14	47268		
	16	47269		
	18	47270		

UC610BL-BN

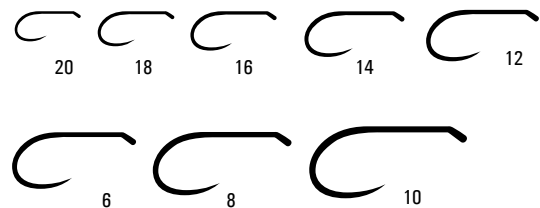

Nymphs- Barbless, 1X Strong, Straight shank, DE, Black Nickel

QUANTITY	SIZE	CODE	COST	SRP
50PK	6	47271	\$7.07	\$12.85
	8	47272		
	10	47273		
	12	47274		
	14	47275		
	16	47276		
	18	47277		
	20	47278		

U- SERIES HOOKS

UC620BL-BN

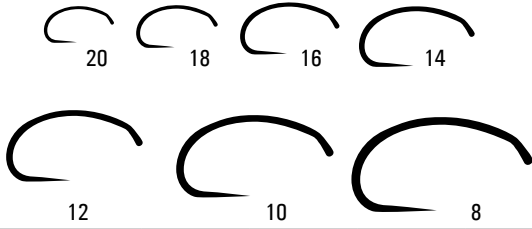

Scuds, Czech Nymphs- Barbless, Curved, Heavy, 1X short, Straight point, DE, Black Nickel

QUANTITY	SIZE	CODE	COST	SRP
50PK	8	47285	\$7.07	\$12.85
	10	47286		
	12	47287		
	14	47288		
	16	47289		
	18	47290		
	20	47291		

UC625BL-BN

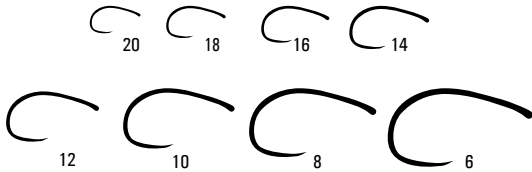

Shrimp, Caddis- Barbless, Curved, 3X Gape, 1X fine, 1X short, Straight eye, Black Nickel

QUANTITY	SIZE	CODE	COST	SRP
50PK	6	47292	\$7.07	\$12.85
	8	47293		
	10	47294		
	12	47295		
	14	47296		
	16	47297		
	18	47298		
	20	47299		

UC655BL-BN

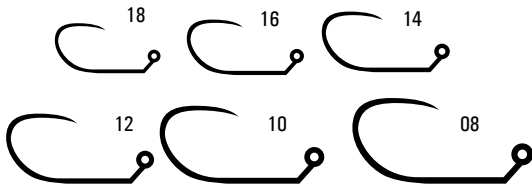

Jiggles Nymphs- Barbless, 60 Degree Jig, Medium wire, Wide Gape, Up-turned point, Black Nickel

QUANTITY	SIZE	CODE	COST	SRP
50PK	8	47245	\$7.07	\$12.85
	10	47246		
	12	47247		
	14	47248		
	16	47249		
	18	47250		

UC650BL-BN

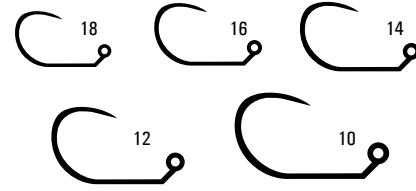

Heavy Weight Jigs- Barbless, 60 Degree Jig, Heavy extra wide gape, Black Nickel

QUANTITY	SIZE	CODE	COST	SRP
50PK	10	47240	\$7.07	\$12.85
	12	47241		
	14	47242		
	16	47243		
	18	47244		

UC660BL-BN

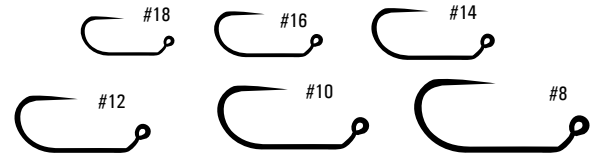

Jiggled Nymphs- Barbless, 60 Degree Jig, Medium wire, Wide Gape, Straight point, Black Nickel

QUANTITY	SIZE	CODE	COST	SRP
50PK	8	47251	\$7.07	\$12.85
	10	47252		
	12	47253		
	14	47254		
	16	47255		
	18	47256		

UC680BL-BN

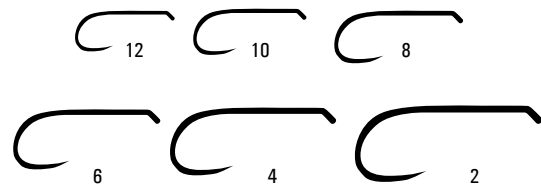

Streamers- Barbless, Straight-shank, Wide Gape, 2X Strong, 2X Long, DE, Black Nickel

QUANTITY	SIZE	CODE	COST	SRP
50PK	2	47279	\$7.07	\$12.85
	4	47280		
	6	47281		
	8	47282		
	10	47283		
	12	47284		

FLIES

LEADER & TIPPET

PACKS & BAGS

ACCESSORIES

HOOKS

TOOLS & KITS

TYING MATERIALS

NECKS & SADDLES

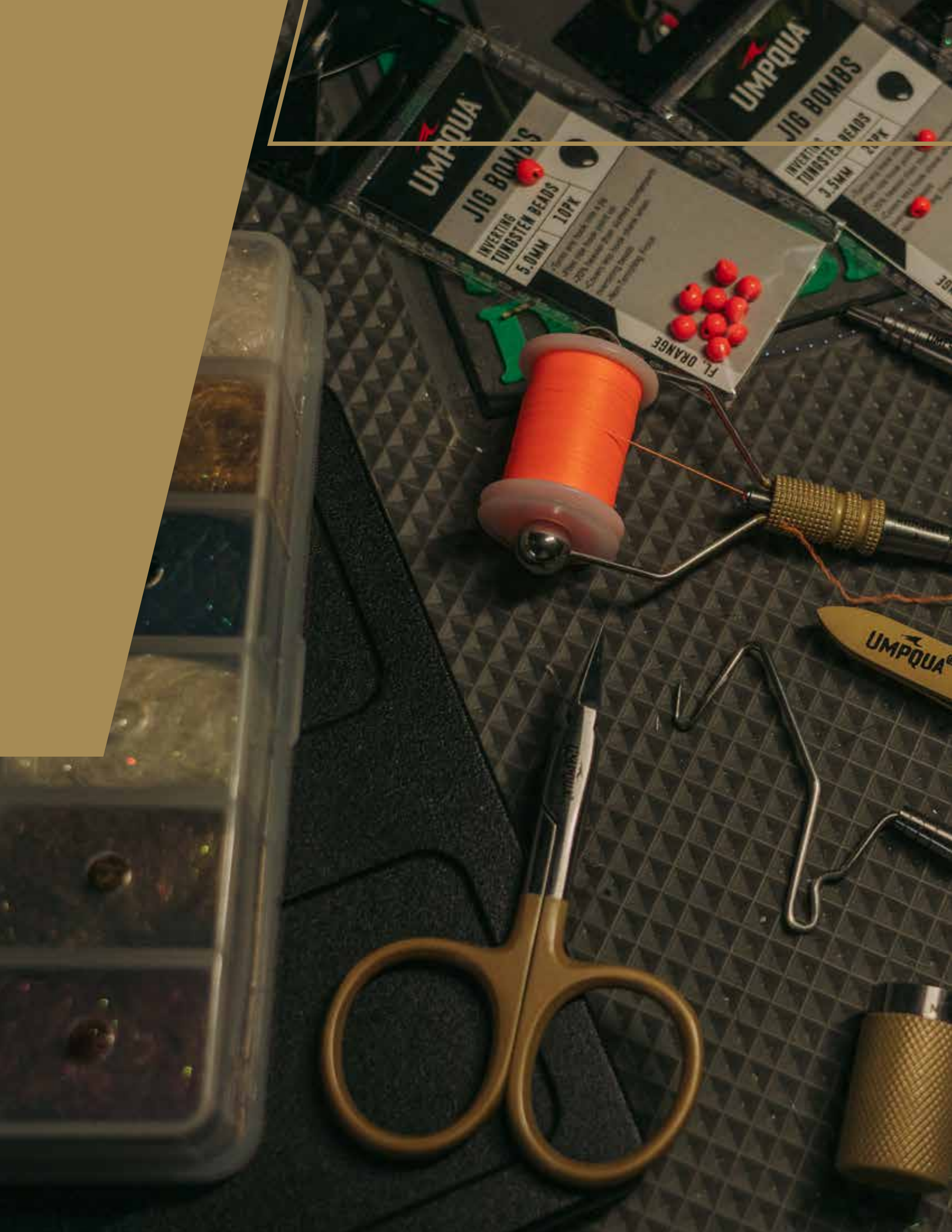

TOOLS & KITS

Over the past four decades, UMPQUA has offered and continues to offer the absolute best in fly tying materials and tools. Our Tiemco™, Metz® and UMPQUA™ products within this section represent the industry's best and provide fly tyers with what they need to create their own unique masterpieces.

347

FLIES

LEADER & TIPPET

PACKS & BAGS

ACCESSORIES

HOOKS

TOOLS & KITS

TYING MATERIALS

NECKS & SADDLES

KITS

UMPQUA™ BEGINNERS FLY TYING KIT

New to tying, and ready to get started? This kit has it all, from Metz™ Hackle, Tiemco™ Hooks, materials, instructions and the tools to get started right, the Beginner's Fly Tying Kit is your ready-to-go set up. With 22 pieces included, open it up and let your bobbin spin. **SRP \$159.99 EA**



35050 \$87.99 EA

DREAM STREAM™ PLUS 7 PIECE KIT

SRP \$84.99 EA



	BLUE	33126	\$46.74 EA
NEW	TAN	33136	\$46.74 EA

All of your essential tying tools in one great travel case. Includes the following Dream Stream + tools: Bobbin, Bodkin, Threader, Whip-finish Tool, Hackle Plier, 5" Scissor & Hair Stacker. Everything you need including a carry case!

DREAM STREAM™ PLUS MASTER TYING TOOL KIT- 12 PIECE

SRP \$124.99 EA



	BLUE	31201	\$68.74 EA
NEW	TAN	33137	\$68.74 EA

Our most popular and essential Dreamstream+ tying tools now available in one great travel kit at one great price. Kit includes: Bobbin, Whip Finish Tool, Bodkin, Hackle Plier, Dubbing Loop Spinner, Dubbing Brush, Standard Hair Stacker, XL Hair Stacker, Bobbin Threader, Dubbing Loop Tweezer, 3.5" Arrow Point Scissor, 4.75" Hair Scissor.

NEW

DREAM STREAM™ PLUS 5 PIECE KIT

SRP \$64.99 EA



	BLUE	33138	\$35.74 EA
	TAN	33139	\$35.74 EA

All of your essential tying tools in one great travel case.

Includes the following Dream Stream + tools: standard bobbin, bodkin, whip-finish tool, hackle plier, and 3.5" arrow point scissor. Everything you need including a carry case!

All scissors are made with surgical-grade Japanese steel and all blades have micro-serrated cutting edges to assure blades both grab and cut.

TOOLS & KITS

DREAM STREAM™ PLUS 3 PIECE SCISSOR KIT



SRP \$38.99 EA

BLUE 33142 \$21.44 EA

One kit that covers all of your cutting needs.

Includes:

3.5" Arrow-Point Scissor

4" All-Purpose Scissor

5.0" Hair Scissor

All scissors are made with surgical-grade Japanese steel and all blades have micro-serrated cutting edges to assure blades both grab and cut.

DREAM STREAM™ 7 PIECE TIE SET



SRP \$54.99 EA



RED 30788 \$30.24 EA

Set Includes: Straight Scissors, Hackle Pliers, Medium Bobbin, Hair Stacker, Threader, Whip Finish Tool, Bodkin



FLIES

LEADER & TIPPET

PACKS & BAGS

ACCESSORIES

HOOKS

TOOLS & KITS

TYING MATERIALS

NECKS & SADDLES

DREAM STREAM

Made with the same surgical-grade Japanese stainless steel as our streamside tools, these tools will make your time at the tying bench easier and more enjoyable. All Dream Stream Tools are available in a red anodized finish. Great looking and performing tools at a great price.

DREAM STREAM™ HAIR STACKER

SRP \$17.99 EA



RED 30798 \$9.89 EA

DREAM STREAM™ CERAMIC BOBBIN

SRP \$14.99 EA



RED 30855 \$8.24 EA

DREAM STREAM™ WHIP FINISHER

SRP \$7.99 EA



RED 30800 \$4.39 EA

DREAM STREAM™ MEDIUM BOBBIN

SRP \$8.99 EA



RED 30794 \$4.94 EA

TOOLS & KITS

DREAM STREAM™ BODKIN WITH HALF-HITCH

SRP \$7.99 EA



RED 30790 \$4.39 EA

DREAM STREAM™ THREADER WITH HALF-HITCH

SRP \$7.99 EA



RED 30792 \$4.39 EA

DREAM STREAM™ 3.5" STANDARD SCISSORS

SRP \$10.99 EA



RED STRAIGHT 30802 \$6.04 EA
RED CURVED 30851 \$6.04 EA

DREAM STREAM™ 3.5" TUNGSTEN CARBIDE SCISSORS

SRP \$21.99 EA



RED STRAIGHT 30853 \$12.09 EA

DREAM STREAM™ HACKLE PLIERS

SRP \$7.99 EA



RED 30796 \$4.39 EA

DREAM STREAM™ 7 PIECE TIE SET

SRP \$54.99 EA



RED 30788 \$30.24 EA

Set Includes: Straight Scissors, Hackle Pliers, Medium Bobbin, Hair Stacker, Threader, Whip Finish Tool, Bodkin

FLIES

LEADER & TIPPET

PACKS & BAGS

ACCESSORIES

HOOKS

TOOLS & KITS

TYING MATERIALS

NECKS & SADDLES

DREAM STREAM PLUS

Umpqua's Dream Stream™ PLUS tying scissors are designed with special care for the discerning fly tyer. The surgical grade Japanese stainless steel micro-serrated blades are shaped and hand set to cut smoothly and crisply through the whole length of the blades.

DREAM STREAM™ PLUS 6 INCH HD SCISSOR

SRP \$24.99 EA



Longer, heavier blades and oversized handles make these scissors ideal for cutting bigger, thicker materials (particularly synthetics). Micro-serrated blades allow for excellent material "grip" and cutting and surgical grade Japanese steel results in long-lasting sharpness. Save your fine-tipped scissors for the finish work and make your material prep easier with these heavy duty (HD) scissors.

BLUE 31200 \$13.74 EA

DREAM STREAM™ PLUS 4.75" HAIR SCISSORS

SRP \$17.99 EA



Ideal for natural materials. Long, heavy, micro-serrated blades grab and cut deer and elk hair easily and precisely. A great all-purpose workhorse for any tyer that spends a lot of time tying big, bushy bugs.

BLUE 31162 \$9.89 EA

DREAM STREAM™ PLUS 3.5" ARROW POINT SCISSORS

SRP \$15.99 EA



Shorter, thinner, micro-serrated blades make this a great precision scissor when tying smaller flies. Sharp, serrated blades grab and cut a wide variety of natural and synthetic materials.

BLUE 31166 \$8.79 EA

DREAM STREAM™ PLUS 4" RAZOR SCISSORS

SRP \$25.99 EA



Ultra thin, razor-sharp, micro-serrated blades made of J2-grade Japanese stainless steel allow you to cut through almost any fly-tying material with ease and accuracy. Tensioner allows for adjusting and tightening blades as desired.

BLUE 31160 \$14.29 EA

DREAM STREAM™ PLUS 4" ALL PURPOSE SCISSORS

SRP \$16.99 EA



Medium length, micro-serrated blades make these a great all-purpose scissor. Sharp, serrated blades grab and cut a wide variety of natural and synthetic materials for all-around use.

BLUE 31164 \$9.34 EA

DREAM STREAM™ PLUS 4.5" SQUIZZORS

SRP \$15.99 EA



Unique squeeze cutting-action allows for a very narrow and streamlined profile that can be held easily in the palm while tying. Short, thin, micro-serrated blades make this a great precision scissor when tying smaller flies. Sharp, serrated blades grab and cut a wide variety of natural and synthetic materials.

BLUE 31168 \$8.79 EA

TOOLS & KITS

DREAM STREAM™ PLUS HD BOBBIN

SRP \$19.99 EA



33124 \$10.99 EA

This heavy duty bobbin allows for even stronger tension control (by bending arms), silky thread-feed and smooth steel tube (minimize thread-breakage). Make sure you have a few of these with your favorite thread colors and Standard Bobbins handy.

DREAM STREAM™ PLUS STANDARD BOBBIN

SRP \$10.99 EA



33129 \$6.04 EA

A workhorse bobbin allows for excellent tension control (by bending arms), silky thread-feed and smooth steel tube (minimize thread-breakage). Make sure you have a few of these with your favorite thread colors handy.

DREAM STREAM™ PLUS DUBBING LOOP SPINNER

SRP \$13.99 EA



BLUE 33123 \$7.69 EA

An invaluable tool if you like to create long, large, complex and durable dubbed bodies. Simply create a thread loop, attach spinner to bottom, place dubbing mix on one side of thread (inside) and spin.

DREAM STREAM™ PLUS TREADER

SRP \$10.99 EA



BLUE 33120 \$6.04 EA

If you are regularly swapping out thread from your bobbin and are tired of hassling with threading and sucking your thread through the tube...this is your tool. The handle "bump" prevents this great tool from rolling off your desk.

DREAM STREAM™ PLUS TYING PICK

SRP \$9.99 EA



BLUE 33119 \$5.49EA

Great for picking out accidentally trapped material or heavily dubbed bodies for maximum "buggy'ness". The handle "bump" prevents this great tool from rolling off your desk.

DREAM STREAM™ PLUS DUBBING BRUSH

SRP \$10.99 EA



BLUE 33116 \$6.04 EA

Enhance the "buggy'ness" of any dubbed body with this unique tool. Great for brushing out palmered buggers or any fly after completion. The handle "bump" prevents this great tool from rolling off your desk.

DREAM STREAM™ PLUS BODKIN

SRP \$10.99 EA



BLUE 33118 \$6.04 EA

No tying bench is complete with out a few of these. Great for picking out a trapped hackle or applying head cement. The Handle "bump" prevents this great tool from rolling off your desk.

DREAM STREAM™ PLUS HALF HITCH TOOL

SRP \$8.99 EA



BLUE 33117 \$4.94 EA

Simple and effective tool for finishing the thread head of any fly or securing thread when changing colors or denier. The handle "bump" prevents this great tool from rolling off your desk.

DREAM STREAM™ PLUS DUB LOOP TWEEZER

SRP \$13.99 EA



BLUE 33141 \$7.69 EA

A versatile, large tweezer which is ideal for creating your own custom dubbing/composite loops and brushes. It can also be used for picking up and placing difficult-to-handle beads, hooks and eyes. The 3.75" tip has a ruler printed on it to help you determine and repeat the correct length every time.

DREAM STREAM™ PLUS WHIP FINISH TOOL

SRP \$13.99 EA



BLUE 33115 \$7.69 EA

Smooth rotation and finish along with an easy-to-grip handle make this the ideal tool to put the finishing touch on any fly.

FLIES

LEADER & TIPPET

PACKS & BAGS

ACCESSORIES

HOOKS

TOOLS & KITS

TYING MATERIALS

NECKS & SADDLES

DREAM STREAM™ PLUS

DREAM STREAM™ PLUS HAIR STACKER



BLUE SMALL	33121	\$8.24	\$14.99
BLUE LARGE	33122	\$10.99	\$19.99

Quickly and easily even the tips of elk, deer, calftail, etc.,. Simply cut clump of hair, brush out any fine underfur and place clump in stacker tips first...bang on desk 5-10 times, turn stacker level, pull tube slowly out of base and grab even tips for tie-in.

DREAM STREAM™ PLUS XL HAIR STACKER



SRP \$21.99 EA

BLUE	33140	\$12.09EA
------	-------	-----------

Ideal when tying large hair-wing flies. A wide, flared opening and smooth machined surface allows for easy loading and removal of hair bundle.

DREAM STREAM™ PLUS HACKLE PLIER



SRP \$10.99 EA

BLUE	33125	\$6.04 EA
------	-------	-----------

Provides excellent grip for both your hand and your hackle. Simply grab hackle-tip in between rubber tips, put finger inside tool and wrap.

DREAM STREAM™ 3 PLUS PIECE SCISSOR KIT



SRP \$38.99 EA

BLUE	33142	\$21.44 EA
------	-------	------------

One kit that covers all of you cutting needs.

Includes:

3.5" Arrow-Point Scissor

4" All-Purpose Scissor

5.0" Hair Scissor

All scissors are made with surgical-grade Japanese steel and all blades have micro-serrated cutting edges to assure blades both grab and cut.

TOOLS & KITS

FLIES

LEADER & TIPPET

PACKS & BAGS

ACCESSORIES

HOOKS

TOOLS & KITS

TYING MATERIALS

NECKS & SADDLES

TIEMCO™ TOOLS

TIEMCO™ RAZOR SCISSORS



SRP \$82.99 EA

STANDARD 30980 \$45.64EA



SRP \$88.99 EA

SERRATED 30995 \$48.94 EA



SRP \$114.99 EA

TUNGSTEN CARBIDE BLADES 30981 \$63.24 EA

TIEMCO™ CERAMIC BOBBIN



NAME	CODE	COST	SRP
STANDARD/STRAIGHT	30901	\$23.09 EA	\$41.99EA
STANDARD/CURVED	30902	\$24.74 EA	\$44.99 EA
HEAVY/STRAIGHT	30903	\$26.39 EA	\$47.99 EA
HEAVY/CURVED	30904	\$26.39 EA	\$47.99 EA
FINE/ STRAIGHT	30920	\$23.09 EA	\$41.99 EA
FINE/ CURVED	30921	\$24.74 EA	\$44.99 EA

TIEMCO™ EVO CERAMIC BOBBIN



NAME	CODE	COST	SRP
STANDARD/STRAIGHT	30922	\$28.59 EA	\$51.99EA
STANDARD/CURVED	30923	\$28.59 EA	\$51.99 EA
HEAVY/STRAIGHT	30924	\$30.24 EA	\$54.99 EA
HEAVY/CURVED	30930	\$30.24 EA	\$54.99 EA

TIEMCO™ ADJUSTABLE DOUBLE ARM BOBBIN

A simple and elegant masterpiece. Tiemco's Double-arm bobbin has a vertically adjustable ceramic tube and two arms on each side to stabilize. Make life at the vise a joy and protect those fine threads. In standard and heavy-duty.

SRP \$87.99 EA



STANDARD	30955	\$48.39 EA
HEAVY DUTY	30956	\$48.39 EA
FINE	30961	\$48.39 EA

TOOLS & KITS

TIEMCO™ TYING NEEDLE

The steep tapered needle does not bend and offers the precision to handle in comfort. This will make the dubbing teasing and other detailed processes an easy task. A half hitcher is included on the other end.

SRP \$41.99 EA



30997 \$23.09 EA

TIEMCO™ WHIP FINISH TOOL — MIDGE

SRP \$30.99 EA



30919 \$17.04 EA

TIEMCO™ BOBBIN THREADER

SRP \$22.99 EA



30915 \$12.64 EA

TIEMCO™ HAIR STACKERS



SRP \$49.99 EA
SRP \$54.99 EA
SRP \$59.99 EA

MICRO	30927	\$27.49EA
SMALL	30928	\$30.24EA
MEDIUM	30929	\$32.99EA

TIEMCO™ RETRACTABLE DUBBING BRUSH

A great tool to control the “bugginess” of your fly bodies. Simply twist the collar to extend or retract the dubbing brush.

SRP \$58.99 EA



30958 \$32.44 EA

TIEMCO™ DUAL FINISHER — WHIP/HALFHITCH MIDGE

The two most common styles of finishing a fly are now available in one fine tool. The perfect finisher for trout flies!

SRP \$58.99 EA



30957 \$32.44 EA

TIEMCO™ DUAL FINISHER- WHIP/HALFHITCH STANDARD

The two most common styles of finishing a fly are now available in one fine tool. The perfect finisher for trout flies!

SRP \$66.99 EA



30962 \$36.84 EA

FLIES

LEADER & TIPPET

PACKS & BAGS

ACCESSORIES

HOOKS

TOOLS & KITS

TYING MATERIALS

NECKS & SADDLES

TIEMCO™ TOOLS

TIEMCO™ TWIN HACKLE GAUGE



SRP \$43.99 EA

30986 \$24.19 EA

TIEMCO™ HACKLE PLIERS



SRP \$9.99 EA

SMALL	30906	\$5.49 EA
STANDARD	30907	

TIEMCO™ SPINNING HACKLE PLIERS

Tiemco Spinning Hackle Pliers are a combination of the pliers and the handle bar connected by a universal joint. They keep hackle perpendicular to hook shanks when wrapping hackles. They also prevent hackle from twisting or breaking. They can be used for tying midge patterns to big flies. These pliers have a silicon soft tip.

SRP \$41.99 EA



LONG 30911 \$22.09 EA



SRP \$39.99 EA

SHORT 30996 \$21.99 EA

TOOLS & KITS



FLIES

LEADER & TIPPET

PACKS & BAGS

ACCESSORIES

HOOKS

TOOLS & KITS

TYING MATERIALS

NECKS & SADDLES



FLY TYING MATERIALS



361

FLIES

LEADER & TIPPET

PACKS & BAGS

ACCESSORIES

HOOKS

TOOLS & KITS

TYING MATERIALS

NECKS & SADDLES

TUNGSTEN JIG BOMBS



Jig Bombs are the solution to add more weight to your flies. The trend of oversizing beads to add more weight means that tyers lose shank length and are limited to what hooks they can use. The unique teardrop shape of the Bomb's means they are about 20% heavier than a standard slotted bead while keeping 15% more hook shank to create a body with. All of this means that flies maintain great proportions and drop into the zone and stay there.

The unique design of the Jig Bomb's will flip any hook and turn it into a Jig and of course it works beautifully on all jig hooks. These Bombs are built into our specialized collection of flats flies called Survive Entry, so the sky is the limit with creativity. Available in 2.5mm-5.0mm and a rainbow of colors.

Jig Bombs are the standard to which all other beads are measured against.

Bead Size	Hook Size	Weight
2.5mm	16-20	2.1 grains
3.0mm	14-18	3.7 grains
3.5mm	10-14	6.0 grains
4.0mm	08-12	9.3 grains
5.0mm	04-10	14.6 grains

COLOR	SIZE	CODE	COLOR	SIZE	CODE
GOLD	2.5 MM	86754	PAINTED BLACK	2.5 MM	86794
	3.0 MM	86755		3.0 MM	86795
	3.5 MM	86756		3.5 MM	86796
	4.0 MM	86757		4.0 MM	86797
	5.0 MM	86758		5.0 MM	86798
SILVER	2.5 MM	86759	PAINTED FL ORANGE	2.5 MM	86799
	3.0 MM	86760		3.0 MM	86800
	3.5 MM	86761		3.5 MM	86801
	4.0 MM	86762		4.0 MM	86802
	5.0 MM	86763		5.0 MM	86803
COPPER	2.5 MM	86764	RADIANT LT PINK	2.5 MM	86774
	3.0 MM	86765		3.0 MM	86775
	3.5 MM	86766		3.5 MM	86776
	4.0 MM	86767		4.0 MM	86777
	5.0 MM	86768		5.0 MM	86778
BLACK NICKEL	2.5 MM	86769	RADIANT BROWN	2.5 MM	86779
	3.0 MM	86770		3.0 MM	86780
	3.5 MM	86771		3.5 MM	86781
	4.0 MM	86772		4.0 MM	86782
	5.0 MM	86773		5.0 MM	86783
PAINTED PINK	2.5 MM	86789	RADIANT ORANGE	2.5 MM	86784
	3.0 MM	86790		3.0 MM	86785
	3.5 MM	86791		3.5 MM	86786
	4.0 MM	86792		4.0 MM	86787
	5.0 MM	86793		5.0 MM	86788

	SIZE	COST	SRP
PAINTED	2.5-3.5MM (20 PK)	\$6.04	\$10.99
	4.0MM (15 PK)	\$7.14	\$12.99
	5.0MM (10 PK)	\$7.14	\$12.99
RADIANT	2.5-3.5MM (20 PK)	\$7.69	\$13.99
	4.0MM (15 PK)	\$8.24	\$14.99
	5.0MM (10 PK)	\$8.24	\$14.99

FLY TYING MATERIALS



FLIES

LEADER & TIPPET

PACKS & BAGS

ACCESSORIES

HOOKS

TOOLS & KITS

TYING MATERIALS

NECKS & SADDLES

EURO LEA

ADHESIVES & BRASS BEADS

ADHESIVES

ZAP-A-GAP™

1/4 oz

30281

12 PK

\$62.56 (SRP\$9.48)



BEAD/HOOK SIZING GUIDE

INCHES	MILLIMETERS	HOOK SIZE
1/16"	1.5 mm	#20-24
5/64"	2.0 mm	#18-22
3/32"	2.3 mm	#14-18
7/64"	2.8 mm	#14-16
1/8"	3.3 mm	#10-14
5/32"	3.8 mm	#10-12
3/16"	4.5 mm	#4-8
7/32"	4.8 mm	#2-8
1/4"	5.3 mm	#2-4

Note - above are guidelines only. Some hook styles may require upsizing to get bead around bend.

FLY TYING MATERIALS

CONEHEADS (20 per pkg)



Gold	3.8 mm	86170	PKG \$4.32/ \$7.85
	4.5 mm	86171	
	4.8 mm	86172	
	5.3 mm	86173	

High quality brass coneheads. Polished and plated. Adds taper and weight to your fly.

HOT BEAD PRICING GUIDE

SIZE	COST	SRP
1.5-3.0MM	\$3.29	\$5.99
4.0-4.5MM	\$3.58	\$6.50

HOT BEADS (24 per pkg)

Chartreuse	1.5mm	86715
	2.0mm	86716
	2.4mm	86717
	2.8mm	86718
	3.0mm	86660
Orange	4.0mm	86661
	4.5mm	86662
	1.5mm	87300
	2.0mm	87301
	2.4mm	87302
Red	2.8 mm	87303
	3.0 mm	86655
	4.0 mm	86656
	4.5 mm	86657
	1.5 mm	87305
Salmon	2.0mm	87306
	2.4mm	87307
	2.8mm	87308
	3.0mm	86665
	4.0mm	86666
White	4.5mm	86667
	1.5mm	87310
	2.0mm	87311
	2.4mm	87312
	2.8mm	87313
Pearl	3.0mm	86645
	4.0mm	86646
	4.5mm	86647
	1.5mm	87315
	2.0mm	87316
	2.4mm	87317
	2.8mm	87318
	3.0mm	87319
	4.0mm	87320
	4.5mm	87321
	1.5mm	87322
	2.0mm	87323
	2.4mm	87324
	2.8mm	87325
	3.0mm	87326
	4.0mm	87327
	4.5mm	87328

Non toxic brass bead in bright, bold colors. Baked on enamel.

BRASS BEADS

COUNTER-SUNK BEADS

24 per pkg,
18 per pkg in 4.6mm



Copper	1.5mm	86427	PKG \$2.17/\$3.95
	2.0mm	86414	
	2.3mm	86415	
	2.8mm	86416	
	3.3mm	86417	
Gold	3.8mm	86418	\$2.34/\$4.25
	1.5mm	86428	\$2.17/\$3.95
	2.0mm	86419	
	2.3mm	86420	
	2.8mm	86421	
Silver	3.3mm	86422	\$2.34/\$4.25
	3.8mm	86423	
	4.6mm	86424	
	1.5mm	86438	\$2.17/\$3.95
	2.0mm	86429	
Black Nickel	2.3mm	86430	
	2.8mm	86431	
	3.3mm	86432	\$2.34/\$4.25
	3.8mm	86433	
	4.6mm	86434	
Black Nickel	1.5mm	86440	\$2.17/\$3.95
	2.0mm	86409	
	2.3mm	86410	
	2.8mm	86411	
	3.3mm	86412	\$2.34/\$4.25
	3.8mm	86413	

This metal bead features a two diameter hole that will fit snugly at the hook eye but have enough clearance to slip over the bend of a variety of hook styles and sizes.

RADIANT BRASS BEADS

20 per pkg



Purple	2.0mm	87840
	2.4mm	87841
	2.8mm	87842
	3.2mm	87843
	3.8mm	87844
Red	2.0mm	87845
	2.4mm	87846
	2.8mm	87847
	3.2mm	87848
	3.8mm	87849
Orange	2.0mm	87850
	2.4mm	87851
	2.8mm	87852
	3.2mm	87853
	3.8mm	87854
Brown	2.0mm	87855
	2.4mm	87856
	2.8mm	87857
	3.2mm	87858
	3.8mm	87859
Olive	2.0mm	87860
	2.4mm	87861
	2.8mm	87862
	3.2mm	87863
	3.8mm	87864
Light Pink	2.0mm	87865
	2.4mm	87866
	2.8mm	87867
	3.2mm	87868
	3.8mm	87869

RADIANT BEAD PRICING GUIDE

SIZE	COST	SRP
2.0- 2.8MM	\$2.56	\$4.65
3.2- 3.8MM	\$2.89	\$5.25

Radiant beads are extremely bright, anodized beads in colors historically not available to fly tiers. Electroplated anodizing results in vivid colors that are extremely scratch and chip resistant. All six colors are available in brass, tungsten and tungsten slotted beads (standard & faceted) make updating and improving existing patterns as simple as sliding on a Radiant Bead. Colors: Purple, Red, Orange, Brown, Olive & Light Pink.

TUNGSTEN BEADS

TUNGSTEN BEADS

20 per pkg, except 12 in 3.8 mm pkg.	Black	2.0 mm	86512	\$4.15	\$7.55
		2.3 mm	86513		
		2.8 mm	86514		
		3.3 mm	86515		
		3.8 mm	86511		
	Copper	2.0 mm	86521		
		2.3 mm	86522		
		2.8 mm	86523		
		3.3 mm	86524		
		3.8 mm	86525		
	Gold	2.0 mm	86529		
		2.3 mm	86530		
		2.8 mm	86531		
		3.3 mm	86532		
	Silver	3.8 mm	86533		
2.0 mm		86535			
2.3 mm		86536			
2.8 mm		86537			
3.8 mm		86538			

High-quality beads that are twice as heavy as brass beads.

TUNGSTEN TARNISHED BEADS

20 per pkg, 3.8 mm pkg.	Gold	2.0 mm	86237	PKG	\$4.15/\$7.55
		2.3 mm	86238		
		2.8 mm	86239		
		3.3 mm	86240		
		3.8 mm	86241		

2.0mm = 5/64"
2.3mm = 3/32"
2.8mm = 7/64"
3.3mm = 1/8"
3.8mm = 5/32"



Twice as heavy as brass with a dull finish that will not spook fish.

RADIANT TUNGSTEN BEADS

20 per pkg	Purple	1.5mm	87875
		2.0mm	87876
		2.4mm	87877
		2.8mm	87878
		3.2mm	87879
		3.8mm	87880
	Red	1.5mm	87881
		2.0mm	87882
		2.4mm	87883
		2.8mm	87884
		3.2mm	87885
		3.8mm	87886
	Orange	1.5mm	87887
		2.0mm	87888
		2.4mm	87889
		2.8mm	87890
		3.2mm	87891
		3.8mm	87892
	Brown	1.5mm	87893
		2.0mm	87894
		2.4mm	87895
		2.8mm	87896
		3.2mm	87897
		3.8mm	87898
	Olive	1.5mm	87899
		2.0mm	87900
		2.4mm	87901
		2.8mm	87902
		3.2mm	87903
		3.8mm	87904
Light Pink	1.5mm	87905	
	2.0mm	87906	
	2.4mm	87907	
	2.8mm	87908	
	3.2mm	87909	
	3.8mm	87910	



MICRO MAYFLY TUNGSTEN
MERCER'S™

SIZE	COST	SRP
1.5-2.4MM	\$4.39	\$7.99
2.8-3.8MM	\$4.94	\$8.99

FLY TYING MATERIALS

TUNGSTEN SLOTTED BEADS

These slotted tungsten beads are ideal on both the Umpqua Competition Series C400 Jig Hook and the Tiemco Jig Hooks. The slot on these beads allows them to pass easily over tight hook gaps while increasing the amount of weight per bead. Considering the increased use of small jig hooks for competition fishing, and the resulting growing interest in tying flies on these hooks, slotted tungsten is almost mandatory as the bead of choice.

TUNGSTEN SLOTTED BEADS 10 PACK

Ideal for use with competition c400 jig hook.



SLOTTED FACETED PRICING

SIZE	COST	SRP
2.0-3.5 MM	\$2.72	\$4.95
4.0 MM	\$3.03	\$5.50
4.5 MM	\$3.49	\$6.35

SLOTTED PRICING

SIZE	COST	SRP
2.0-3.3 MM	\$2.72	\$4.95
3.8MM	\$3.03	\$5.50
4.6 MM	\$3.49	\$6.35

HOOK BEAD CHART

	SIZE	JIG SIZE 16	14	12	10	8
SLOTTED STANDARD	2.3mm	✓				
SLOTTED FACETED	2.5mm	✓				
SLOTTED STANDARD	2.8mm	✓	✓			
SLOTTED FACETED	3.0mm	✓	✓			
SLOTTED STANDARD	3.3mm		✓	✓		
SLOTTED FACETED	3.5mm		✓	✓		
SLOTTED STANDARD	3.8mm			✓	✓	
SLOTTED FACETED	4.0mm			✓	✓	
SLOTTED FACETED	4.5mm				✓	✓
SLOTTED STANDARD	4.6mm				✓	✓

	COLOR	SIZE	CODE
SLOTTED FACETED	GOLD	2.0 MM	86750
		2.5 MM	86676
		3.0 MM	86677
		3.5 MM	86678
		4.0 MM	86679
		4.5 MM	86680
	BLACK	2.0 MM	86751
		2.5 MM	86682
		3.0 MM	86683
		3.5 MM	86684
		4.0 MM	86685
		4.5 MM	86686
	SILVER	2.0 MM	86752
		2.5 MM	86688
		3.0 MM	86689
		3.5 MM	86690
		4.0 MM	86691
		4.5 MM	86692
	COPPER	2.0 MM	86753
		2.5 MM	86694
		3.0 MM	86695
		3.5 MM	86696
		4.0 MM	86697
		4.5 MM	86698

	COLOR	SIZE	CODE
SLOTTED	GOLD	2.0 MM	86744
		2.3 MM	86721
		2.8 MM	86722
		3.3 MM	86723
		3.8 MM	86724
		4.6 MM	86725
	BLACK	2.0 MM	86745
		2.3 MM	86727
		2.8 MM	86728
		3.3 MM	86729
		3.8 MM	86730
		4.6 MM	86731
	SILVER	2.0 MM	86746
		2.3 MM	86733
		2.8 MM	86734
		3.3 MM	86735
		3.8 MM	86736
		4.6 MM	86737
	COPPER	2.0 MM	86747
		2.3 MM	86739
		2.8 MM	86740
		3.3 MM	86741
		3.8 MM	86742
		4.6 MM	86743

FLIES

LEADER & TIPPET

PACKS & BAGS

ACCESSORIES

HOOKS

TOOLS & KITS

TYING MATERIALS

NECKS & SADDLES

TUNGSTEN SLOTTED BEADS

RADIANT TUNGSTEN SLOTTED BEADS

10 PACK

	COLOR	SIZE	CODE
SLOTTED FACETED	PURPLE	2.0 MM	87915
		2.5 MM	87916
		3.0 MM	87917
		3.5 MM	87918
		4.0 MM	87919
		4.6 MM	87920
	RED	2.0 MM	87921
		2.5 MM	87922
		3.0 MM	87923
		3.5 MM	87924
		4.0 MM	87925
		4.5 MM	87926
	ORANGE	2.0 MM	87927
		2.5 MM	87928
		3.0 MM	87929
		3.5 MM	87930
		4.0 MM	87931
		4.6 MM	87932
	BROWN	2.0 MM	87933
		2.5 MM	87934
		3.0 MM	87935
		3.5 MM	87936
		4.0 MM	87937
		4.6 MM	87938
OLIVE	2.0 MM	87939	
	2.5 MM	87940	
	3.0 MM	87941	
	3.5 MM	87942	
	4.0 MM	87943	
	4.6 MM	87944	
LIGHT PINK	2.0 MM	87945	
	2.5 MM	87946	
	3.0 MM	87947	
	3.5 MM	87948	
	4.0 MM	87949	
	4.6 MM	87950	

	COLOR	SIZE	CODE
SLOTTED	PURPLE	2.0 MM	87951
		2.3 MM	87952
		2.8 MM	87953
		3.3 MM	87954
		3.8 MM	87955
		4.6 MM	87956
	RED	2.0 MM	87957
		2.3 MM	87958
		2.8 MM	87959
		3.3 MM	87960
		3.8 MM	87961
		4.6 MM	87962
	ORANGE	2.0 MM	87963
		2.3 MM	87964
		2.8 MM	87965
		3.3 MM	87966
		3.8 MM	87967
		4.6 MM	87968
	BROWN	2.0 MM	87969
		2.3 MM	87970
		2.8 MM	87971
		3.3 MM	87972
		3.8 MM	87973
		4.6 MM	87974
	OLIVE	2.0 MM	87975
		2.3 MM	87976
		2.8 MM	87977
		3.3 MM	87978
		3.8 MM	87979
		4.6 MM	87980
LIGHT PINK	2.0 MM	87981	
	2.3 MM	87982	
	2.8 MM	87983	
	3.3 MM	87984	
	3.8 MM	87985	
	4.6 MM	87986	

SIZE	COST	SRP
2.0-3.5MM	\$3.03	\$5.50
4.0MM	\$3.38	\$6.15
4.6MM	\$3.66	\$6.65

SIZE	COST	SRP
2.0-3.3MM	\$3.03	\$5.50
3.8MM	\$3.38	\$6.15
4.6MM	\$3.66	\$6.65

FLY TYING MATERIALS

FLIES

LEADER & TIPPET

PACKS & BAGS

ACCESSORIES

HOOKS

TOOLS & KITS

TYING MATERIALS

NECKS & SADDLES

TAILING FIBERS

BETTS' TAILING FIBERS



Brown	88001	PKG	\$2.50 // \$4.55
Cream	88002		
Dark Dun	88003		
Ginger	88004		
Mahogany	88005		
Medium Dun	88006		
Olive	88007		
White	88008		

Nylon tail material that is thinner than hackle stems and practically unbreakable. Ultra thin, they have a fine tapered point. Perfect for tailing mayflies but also can be used as antennae.

BETTS' TAILING FIBERS



Assortment 88010 EA \$17.59 // \$31.99

Cream
Dark Dun
Ginger
Mahogany
Medium Dun
Olive
White

Color assortment of the tailing fibers described above.

BETTS' STANDARD Z-LON™



Amber	88119	PKG	\$4.39 // \$7.99
Black	88118		
Brown	88101		
Cream	88102		
Dark Dun	88103		
Dark Olive	88113		
Dun	88104		
Ginger	88105		
Green	88111		
Light Dun	88106		
Light Olive	88112		
Olive Brown	88107		
Orange	88116		
Red	88114		
White	88108		
Yellow	88115		

Z-lon is a synthetic material that has many uses. Long and straight Z-lon can be used on spinner wings, sparkle dun shucks, caddis emerger cases and tails. Can be used as a replacement for antron.

BETTS' STANDARD Z-LON™ ASSORTMENT KITS

Insect Colors 88147 EA \$10.44 // \$18.99

Color assortment of the Z-Lon for insect patterns.

BETTS' Z-LON™, KINKY



Amber	88130	PKG	\$4.39 // \$7.99
Black	88129		
Brown	88121		
Cream	88122		
Dark Dun	88123		
Dark Olive	88133		
Dun	88124		
Ginger	88125		
Light Dun	88126		
Light Olive	88132		
Olive Brown	88127		
White	88128		
Gold Ginger	88131		
Yellow	88135		

Kinky Z-lon is a synthetic material that has many uses. Very crinkly it can be used as wing material or as a very coarse dubbing. Makes nice emergent caddis pupae, shucks, tails, and wings.

FLY TYING MATERIALS



FLIES

LEADER & TIPPET

PACKS & BAGS

ACCESSORIES

HOOKS

TOOLS & KITS

TYING MATERIALS

NECKS & SADDLES



METZ[®] SADDLES & NECKS



FLIES

LEADER & TIPPET

PACKS & BAGS

ACCESSORIES

HOOKS

TOOLS & KITS

TYING MATERIALS

NECKS & SADDLES

373

HACKLE NECKS

METZ® HACKLE NECKS



NOTE: PLEASE NOTE THAT PRICES ARE SUBJECT TO CHANGE WITHOUT NOTICE DUE TO UNFORESEEN INCREASES IN FEED COSTS, CORN, AND FUEL CHARGES.

METZ® SADDLES & NECKS



MORE FEATHERS:



SHOULDERS / SPADE HACKLE IS NO LONGER GOING TO BE TRIMMED AWAY.

THIS MEANS YOU GET A HUGE INCREASE IN USE-ABLE FEATHERS, (THE BEST DRY FLY TAILING MATERIAL THERE IS) AT NO ADDITIONAL COST.

THESE ARE THE FEATHERS THAT MANY CREATIVE TYERS HAD TO SCROUNGE FOR, OR TO PURCHASE SEPARATELY...NOW INCLUDED.

#1 METZ® NECK

\$73.00 \$132.75

Badger, Golden	90103
Badger, Silver	90106
Black Natural	90109
Brown	90115
Chocolate Dun	90118
Cream	90121
Dun	90127
Furnace	90130
Grizzly	90133
Ginger	90136
Barred Ginger	90142
Light Blue Dun	90145
Medium Dun	90148
Variant	90154
Barred Variant	90157
White Splash	90160

#1 METZ® MAGNUM NECK

\$41.50 \$75.50

Cream	98321
Cream, Blue	98330
Cream, Chartreuse	98326
Cream, Olive	98327
Cream, Orange	98329
Cream, Pink	98331
Cream, Purple	98332
Cream, Tan	98324
Cream, Yellow	98328
Dyed Black	98312
Grizzly	98333
Grizzly, Blue	98340
Grizzly, Chartreuse	98336
Grizzly, Olive	98337
Grizzly, Orange	98339
Grizzly, Pink	98341
Grizzly, Purple	98342
Grizzly, Tan	98334
Grizzly, Yellow	98338



FLIES

LEADER & TIPPET

PACKS & BAGS

ACCESSORIES

HOOKS

TOOLS & KITS

TYING MATERIALS

NECKS & SADDLES

HACKLE NECKS



#2 METZ® NECK	\$57.75	\$105.00	#2 METZ® COMBO NECK	\$57.75	\$105.00
Badger, Golden	90203		Grizzly/Brown	90282	
Badger, Silver	90206		Grizzly/Dun	90283	
Black Natural	90209		Dun/Brown	90284	
Black Dyed	90212				
Brown	90215				
Chocolate Dun	90218				
Cream	90221				
Dun	90227				
Grizzly	90233				
Ginger	90236				
Barred Ginger	90242				
Light Blue Dun	90245				
Medium Dun	90248				
Variant	90254				
Barred Variant	90257				
White Splash	90260				

#2 METZ® MAGNUM NECK	\$32.75	\$59.75
Cream	98821	
Cream, Blue	98830	
Cream, Chartreuse	98826	
Cream, Olive	98827	
Cream, Orange	98829	
Cream, Pink	98831	
Cream, Purple	98832	
Cream, Tan	98824	
Cream, Yellow	98828	
Dyed Black	98812	
Grizzly	98833	
Grizzly, Blue	98840	
Grizzly, Chartreuse	98836	
Grizzly, Olive	98837	
Grizzly, Orange	98839	
Grizzly, Pink	98841	
Grizzly, Purple	98842	
Grizzly, Tan	98834	
Grizzly, Yellow	98838	

Same qualities but a little narrower than a #1.

#2 METZ® HALF NECK	\$32.00	\$58.25
Badger, Golden	91203	
Badger, Silver	91206	
Black Natural	91209	
Black Dyed	91212	
Brown	91215	
Chocolate Dun	91218	
Cream	91221	
Dun	91227	
Grizzly	91233	
Ginger	91236	
Barred Ginger	91242	
Light Blue Dun	91245	
Medium Dun	91248	
Variant	91254	
Barred Variant	91257	
White Splash	91260	

#2 METZ® HALF NECK DIED OVER GRIZZLY	\$32.00	\$58.25
Tan	91232	
Lt Blue Dun	91234	
Olive	91235	



#2 METZ® NECK DIED OVER GRIZZLY	\$57.75	\$105.00
Tan	90232	
Lt. Blue Dun	90234	
Olive	90235	

METZ® SADDLES & NECKS



#3 METZ® NECK

Badger, Golden	90303
Badger, Silver	90306
Black Natural	90309
Black Dyed	90312
Brown	90315
Chocolate Dun	90318
Cream	90321
Dun	90327
Furnace	90330
Grizzly	90333
Ginger	90336
Barred Ginger	90342
Light Blue Dun	90345
Medium Dun	90348
Rusty Dun	90351
Variant	90354
Barred Variant	90357
White Splash	90360

\$43.00

\$78.00

#3 METZ® HALF NECK

Badger, Golden	91303
Badger, Silver	91306
Black Natural	91309
Black Dyed	91312
Brown	91315
Chocolate Dun	91318
Cream	91321
Dun	91327
Furnace	91330
Grizzly	91333
Ginger	91336
Barred Ginger	91342
Light Blue Dun	91345
Medium Dun	91348
Rusty Dun	91351
Variant	91354
Barred Variant	91357
White Splash	91360

\$24.25

\$44.25

#3 METZ® NECK DIED OVER GRIZZLY

Tan	90332
Lt. Blue Dun	90334
Olive	90335

\$43.00

\$78.00

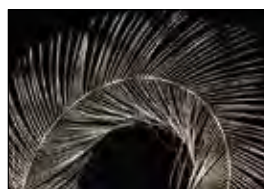

#3 METZ® COMBO NECK

Grizzly/Brown	90382
Grizzly/Dun	90383
Dun/Brown	90384

\$43.00

\$78.00



For dry flies size 12 and smaller, Wooly Buggers and Streamers in your favorite colors.

#3 METZ® HALF NECK DIED OVER GRIZZLY

Tan	91332
Lt Blue Dun	91334
Olive	91335

\$24.25

\$44.25

DAVE'S FOAM HOPPER

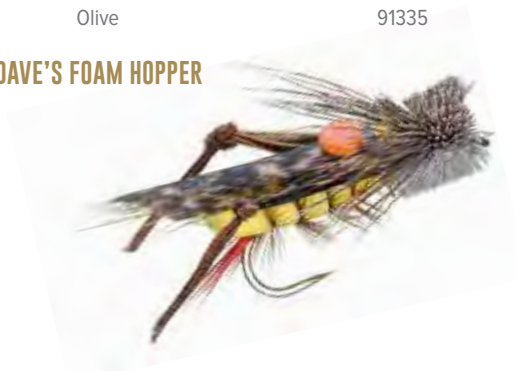

FLIES

LEADER & TIPPET

PACKS & BAGS

ACCESSORIES

HOOKS

TOOLS & KITS

TYING MATERIALS

NECKS & SADDLES

SADDLES

#1 METZ® SADDLE

Badger, Golden	92103
Badger, Silver	92106
Black Natural	92109
Black Dyed	92112
Brown	92115
Chocolate Dun	92118
Cream	92121
Dun	92127
Furnace	92130
Grizzly	92133
Ginger	92136
Barred Ginger	92142
Light Blue Dun	92145
Medium Dun	92148
Rusty Dun	92151
Variant	92154
Barred Variant	92157
White Splash	92160

\$47.00 \$85.50

#2 METZ® SADDLE

Badger, Golden	92203
Badger, Silver	92206
Black Natural	92209
Black Dyed	92212
Brown	92215
Chocolate Dun	92218
Cream	92221
Dun	92227
Furnace	92230
Grizzly	92233
Ginger	92236
Barred Ginger	92242
Light Blue Dun	92245
Medium Dun	92248
Variant	92254
Barred Variant	92257
White Splash	92260
Dyed Olive	92278

\$41.50 \$75.50

#1 METZ® MAGNUM SADDLE

Cream	98421
Cream, Blue	98430
Cream, Chartreuse	98426
Cream, Olive	98427
Cream, Orange	98429
Cream, Pink	98431
Cream, Purple	98432
Cream, Tan	98424
Cream, Yellow	98428
Dyed Black	98412
Grizzly	98433
Grizzly, Blue	98440
Grizzly, Chartreuse	98436
Grizzly, Olive	98437
Grizzly, Orange	98439
Grizzly, Pink	98441
Grizzly, Purple	98442
Grizzly, Tan	98434
Grizzly, Yellow	98438

\$48.75 \$88.50

#2 METZ® MAGNUM SADDLE

Cream	98221
Cream, Blue	98230
Cream, Chartreuse	98226
Cream, Olive	98227
Cream, Orange	98229
Cream, Pink	98231
Cream, Purple	98232
Cream, Tan	98224
Cream, Yellow	98228
Dyed Black	98212
Grizzly	98233
Grizzly, Blue	98240
Grizzly, Chartreuse	98236
Grizzly, Olive	98237
Grizzly, Orange	98239
Grizzly, Pink	98241
Grizzly, Purple	98242
Grizzly, Tan	98234
Grizzly, Yellow	98238

\$40.75 \$74.00



Perfect palmering hackle for large flies or any fly that requires large hackle. Wider than most saddle hackle and available in dyed colors.

Same great qualities as the #1 Magnum Hackle but a little shorter in length.

METZ® SADDLES & NECKS

#1 METZ® MICRO-BARB SADDLE \$66.25 \$120.50

Brown	93115
Cream	93121
Grizzly	93133
Ginger	93136
Light Blue Dun	93145
Variant	93154
Barred Variant	93157

#1 METZ® MICRO-BARB SADDLE \$66.25 \$120.50

DIED OVER GRIZZLY

Black	93112
Tan	93132
Light Blue Dun	93134
Olive	93135

#2 METZ® MICRO-BARB SADDLE \$51.50 \$93.75

Brown	93215
Cream	93221
Grizzly	93233
Ginger	93236
Dyed Black	93212
Light Blue Dun	93245
Variant	93254
Barred Variant	93257

#2 METZ® MICRO-BARB SADDLE \$51.50 \$93.75

DIED OVER GRIZZLY

Black	93212
Tan	93232
Light Blue Dun	93234
Olive	93235

METZ® HEN MATERIAL

QUANTITIES LIMITED ON ALL HEN MATERIALS

#1 METZ® HEN NECK \$20.75 \$37.75

Black	95109
Cream	95121
Dun	95127
Dyed Black	95112
Furnace	95130
Ginger/Brown	95139
Grizzly	95133
White Splash	95160

#1 METZ® HEN SADDLE \$14.50 \$26.50

Black	96109
Cream	96121
Dun	96127
Dyed Black	96112
Ginger/Brown	96139
Grizzly	96133
White Splash	96160

FLIES

LEADER & TIPPET

PACKS & BAGS

ACCESSORIES

HOOKS

TOOLS & KITS

TYING MATERIALS

NECKS & SADDLES

COLOR CHART: SADDLES



BADGER SILVER



GINGER



BROWN



MEDIUM DUN



CREAM



WHITE SPLASH



GRIZZLY



LIGHT BLUE DUN



BADGER GOLDEN



BLACK



CHOCOLATE DUN



DUN



RUSTY DUN

METZ® SADDLES & NECKS



<METZ #3 NECK CE
0 [barcode]

FLIES

LEADER & TIPPET

PACKS & BAGS

ACCESSORIES

HOOKS

TOOLS & KITS

TYING MATERIALS

NECKS & SADDLES



INDICES

■ SIGNATURE FLY INDEX
PAGE 384

■ GENERAL FLY INDEX
PAGE 390



383

SIGNATURE FLY INDEX BY DESIGNER

Adler™, Nick	
Nick's Fat Caddass	114, 133

Alexander™, Brandon	
Bumpin Bunny	188

Anderson™, George	
McCrab	177

Anderson™, Mickey	
UV Juan	140
UV Sally	126

Anderson™, Rob	
Reducer	60, 84, 196
Space Invader	55, 60, 184, 196

Anderson™, Russell	
Sparky's Floating Spider	57, 93

Andrews™, Jeff "Bear"	
Bear's Crossdresser	156, 166
Bear's Hi-Viz Borchter Moosetail	66
Bear's Hi-Viz Brown Drake	70
Bear's Saddleback Hex	104, 166
Clear Wing Spinner Brown Drake	80
Clear Wing Spinner Hex	80
Clear Wing Spinner Trico	80

Armstrong™, Daniel	
Hood Rat Articulated	168

Bachmann™, Troy	
Saltwater Dorado Popper	191

Bakelaar™, Theo	
Boatman	146
San Juan Worm	140

Ballok™, Dave	
Ballok's™ Big Boy	62
Northwoods Ninja	62

Barr™, John/Craven™, Charlie	
B/C Dropper Hopper	90

Barr™, John	
Barr's™ Uncased Caddis	108
Bead Head Emerger	96
Black Back Emerger	96
Bouface, Brass Bead	58, 72, 146
Copper John	106
Copper John Jig	106
Crane Fly Larva	106
Damsel	146
Dark Back Emerger	97
Drowned Spinner	80
Emerger (Wet)	97
Flashback Emerger	98
Graphic Caddis	108
Meat Whistle	55, 158, 166
Net Builder Caddis	114
Pure Midge Larva	100
Rubberleg Copper John Stlhd	166
Slump Buster	160
Tungstone Flashback	125
Vis-A-Dun	83

Bauer™, Brent	
Crafty Shrimp	176

Baxter™, Ben	
Bearded Baetis	104, 129

Beck™, Barry and Cathy	
Cathy's Fleeing Crab	174
Polyfluff Caddis	79
Sili Legs	178
Sili Legs Lite	178
Super Bugger	53, 149

Befus™, Brad	
Para Emerger	100
Slow Water Sally	79
Wired Stonefly	126

Bennett™, Matt	
Bennett's™ Lunch \$	54, 156

Best™, A.K.	
Callibaetis Spinner	80, 146
March Brown	76
Melon Quill	76
Parachute	78
Trico Dun	83

Birchby™, Todd	
Para Damsel, Birchby's™	78

Bishop™, Bret	
Bishop's Dynamite	104, 129

Blados™, Joe	
Crease Fly	56, 60, 182, 191, 194

Blanton™, Dan	
Flashtail Minnow Jig	182, 188
Flashtail Whistler	60, 62, 182, 195

Blessing™, Greg	
Purple Haze Emerger	100

Blumenshine™, Matt	
Tungsten Junior Mint	150, 155

Bond™, John	
Deep Cleaner	107, 130
Dragon	157
Dragon Mini	157

Boyer™, Todd	
Todd's Wiggle Minnow	57, 62, 161, 185, 191, 196

Boyle™, Caleb	
Caleb's Bee	92

Brown™, Del	
Permit Crab	178

Burk™, Andy	
Adult Damsel	66, 146
Crystal Hunchback	106
Crystal Hunchback TB	106
Damsel	147
Hexagenia	108

Hunchback (Infrequens)	108
Hunchback Green Drake	108
Hunchback Two-Tone	108
Sierra Damsel	150
Silhouette Dun	79

Cady™, Alex	
Tungsten Zebra Two-Tone	101, 127, 151

Cannon™, Jim	
Cannon's™ Worm	140

Caranci™, Michael	
Bad Attitude Bait	194

Chicone™, Drew	
Bone Appetite	174
Contraband Crab	176
Coyote Spawn Shrimp	176
Coyote Shrimp	176
Disco Shrimp	176
King Rat Small	57, 168
Magnum Mantis	177
Mayhem Mole Crab	177
Nightmare Needle Fish	177
Peyote Palolo	188
Pineapple Grenade Popper	57, 191
Punisher	188
Tide Slave	179
Tuscan Bunny	185, 197

Chouinard™, Dave	
Chewy's Bender	174
Chewy's Chewceiver	174
Chewy's Cyborg Shrimp	175
Chewy's Cyclops	175
Chewy's Fit for a King	188
Chewy's Halo Shrimp	175
Chewy's Island Time	175
Chewy's Minnr	175
Chewy's Morsel	175
Chewy's Tarponator	188

Chouinard™, Yvon	
Improved Pheasant Tail	98, 116

Collier™, Dennis	
Bread N' Butter Bugger	154

Conner™, Mike	
Glades Minnow	177, 195
Midnight Minnow	55, 158, 177, 183, 195
Midnight Mullet	55, 177, 183, 195

Cotter™, Riley	
CZ Caddis Tungsten	106, 130
Tungsten Drowned Ant	87, 124

Cowen™, Henry	
Bonefish Scampi (Bead Chain)	174
Bonefish Scampi (Lead Eye)	174
Cowen's™ Baifish	182, 194

Coyote	54, 182, 194
Redfish Scampi	178
Redfish Scampi BC	178
Somehthin Else	55, 191, 196

Craven™, Charlie	
Baby Boy Hopper	90
Baby Gonga	158
Big Fat Angie	92
Bonefish Junk	174
Boy Wonder Hopper	90
Caddistropic Pupa	106
CDC Stone	106
Charlie Boy Hopper	90
Charlie's Mysis	142
Dirty Hippy	157
Double Dirty Hippy	157
Double Gonga	158
Drunken Suzy	69
Fat Angie	93
Jeffrey Dauber	93
Juju Baetis	111
Juju Baetis (Tungsten)	111
Juju PMD	111
Juju Sally	111
Jujubee Midge	98
Jujubee Midge Flash	98
Jumbo Juju Chironomid	98, 148
Lucky B	93
Mole Fly	99
Mole Midge	99
Morningwood Hopper	90
Morningwood Special	77

Mr. Jones	77
Nine LB Hammer	154, 160
Pine Squirrel Leech	149
Poison Tung	114
Problem Child	118
Soft Hackle Emerger	100
Swim Coach	160
Swim Coach Baby	160
Two Bit Drake	125
Two Bit Hooker	126
Two Bit Hooker Jig	126, 135
Two Bit Midge	101
Two Bit Stone	126

Cutter™, Ralph	
E/C Caddis	69
Little Yellow Stonefly	76

Dahlberg™, Larry	
Diving Bug (Weedless)	56
Skipper	57

Davidson™, Kevan Lee	
Chubby Cubby	78
LED Chironomid	148
LED Midge	98
Cupboard Ant	87
Sow Chow	142
Sow Chow Tungsten	142

Davis™, Scott	
Drum Beater	176
deGala™, Herman	
CDC Callibaetis Nymph	106, 146
Hula Damsel	148
Dennis™, Jack	
Amy's Ant	66, 92
ParaWulff	70, 78
Dorsey™, Forrest	
Buckskin Jig	105, 129
CDC Cased Caddis Jig	106, 130
Lightning Leech	148
Manhattan Midge	99
Doctor™, Garrison	
Flexy Stone	107
Sweetmeat Caddis	123, 134
Sweetmeat Caddis Deep	123, 134
Sweetmeat Sally	124, 134
Dorsey™, Pat	
Black Beauty	96
Black Beauty Flashback	96
Bread Crust Jig	105, 129
Dorsey's UV Scud	142
Limeade	75
Medallion Midge Pupa	99
Mercury Flashback PT	116
Mercury Series	99, 113
Mercury SH Pheasant Tail	113, 116
Pat's Bread Crust	114
Pat's Midge	100
Top Secret Baetis	124
Top Secret Midge	101
Tungsten Mercury Caddis	124
Dorsy™, Patrick	
Kwan (Bead Chain)	177
Drummond™, Tim	
Rusty Nail Perdigon	122, 134
Tim's 0351	124
Tim's Beetle	89
Tim's Beetle 2.0	89
Tim's Stone	124
Eakins™, Daryl	
Detroit Mop City	58
Hipster Dufus	58
HVRT Carp Fly	58
Easdon™, Jon	
Blindside Midge	96
Slapshot Scud	142
Egan™, Lance	
Bionic Ant	86, 129
Bionic Ant 2.0	86, 129
Corn-Fed Caddis (CDC)	68, 130
Corn-Fed Caddis Rubberlegs	68, 130
Corn-Fed Sally (CDC)	68, 130
Corn-Fed Spruce Moth	68
Frenchie	108, 131
Frenchie Chironomid	131, 147
Frenchie Jig	108, 131

GTI Caddis	108
Headstand	58
Iron Lotus	109, 131
Iron Lotus Jig	109, 131
Rainbow Warrior	120
Rainbow Warrior CDC Tung	120, 133
Rainbow Warrior Jig	120, 133
Rainbow Warrior (Tungsten)	120, 133
Rainbow Warrior X-Hvy	120, 134
Silver Bullet Baetis	122, 134
Tailwater Sowbug	143
Tailwater Sowbug CDC	143
Tailwater Sowbug CDC Jig	134, 143
Tailwater Sowbug Tungsten	143
Tailwater Sowbug Jig	135, 143
Thread Frenchie Jig	124, 135
Tungsten Dart	124, 135
Tungsten Surveyor	125, 135
Warrior Perdigon	126, 135
Engler™, Mark	
WD-40	101, 126
Feller™, Brandon	
Seed Beetle	89
Flick™, Art	
March Brown	76
Fowler™, Bill	
Gunnison Green Drake	70
Fox™, Tim	
Caddis Poopah	105
Caddis Poopah BH	105
Freed™, Aaron	
Razor Mayfly	79
Stubby Ant	87
Summer Stone	83
Garcia™, Greg	
Darth Baetis	107
Mini Hot	76
Mini Hot Mayfly	76
Mother's Day Caddis	77
Mother's Day Sally	77
Rojo Midge	100
Gerbec™, Alec	
Alphexo Crab	174
Po Boy	178
Polar Prawn	178
Resting Caddis	79
Ginop™, Zachary	
Wedge Head	161
Gomez™, Johnny	
Desert Storm (Glass Bead)	97
Gorman™, Michael	
Bead Head Egg (Barbless)	138
Graffam™, Josh	
Golden Nugget	108, 131
Hustler CDC	108, 131
Grillos™, Andrew	
64 Impala	66
Dancin' Ricky	69

El Camino	69
Great Carpholio Jig	58
Hamburgler	89
Hippie Stomper	74
Mini Hippie Stomper	76
Superior Spruce Moth	83, 93
User Friendly	83
Gunkel™, Shea	
Radiation Baetis	115
Shotglass Baetis	122
Shotglass Emerger Dun	122
Splatte Roller	123
Hada™, Duane	
Creek Crawler	54, 106
Haddon™, Tim	
Dead Drift Crayfish	54, 107
Haines™, Larry	
Supreme Hair Rattle Shrimp	188, 196
Supreme Hair Shrimp	179, 196
Hanner™, Randy	
Hot Bead Jolly Rancher	131, 148, 154
Jigged Green Drake	109, 132
Plan C Caddis	114, 133
Hansen™, Chris	
Stay Hungry Streamer	55
Hart™, Ron	
Dark Lord	118
Hebert™, Pierre	
Pink Plerre, Hebert	114
Heng™, Tim	
Autumn Splendor	154
Hickman™, Jeff	
Fish Taco	164
Mini Hankey	168
Mr. Hankey	168
Skiddish Smolt	160, 165
Hieronymus™, Mark	
Choker	138, 166
Party Girl	164
Twofer	166
Hochner™, Lex	
Boobie Crab	174
Captain Gregg	174
Dirty Hair	176
Lexo's Pop Up Crab	177
One Armed Bandit	178
Perminator	178
Hogan™, Dec	
Black & Orange	164
Black Dress	164
DC Prawn	164
Mahony	164
Howard™, Marty	
Bi-wing Drake	70
Summer Iron	165
Tail Dragger Tube	165

Winter's Hope 451	165
Horodysky™, Andrij	
Mohawk Beetle	89
Mopsicle (Tungsten)	113, 133
Mini Mopsicle	113, 133
Nitro Caddis Pupa	114
Hudspeth™, Brian	
Atomic Stone	104
Hud's Bushwhacker	55, 62, 158, 195
Iwane™, Phil	
Iwan-e-Dun Parachute	75
Last Gasp Ant	87
No Mercy Midge	100
Jackson™, Blake	
Ditch Witch	157
Macgruber, Jackson's™	112
Janik™, Anthony	
Blind Faith Merkwan	174
Fight N Flee Fiddler	176
Mayport Select Shrimp	177
Swiss Army Slider	179
Jansen™, Frans	
Techno-Wog	168
Johnson™, Chris	
BC Streamer	129, 156
Big Fat Ant	86
Chuckwagon	156
Creek Leech	157
Mimic Hopper	90
Mimic May	76
Rio Bandito	120, 134
Spruce Almighty	82
Super Sally	83
Kaufmann™, Randall	
CDC Flashback PT	115
Christmas Island Special	175
Crystal Stimulator	82
Crystal Stimulator Rubberlegs	82
Scud	142
Stimulator	82
Kelso™, Brian	
Mayhem Jig	113, 132
King™, Zach	
Colonel Kurtz	157
Long Haired Hippie	112
Kingrey™, Larry	
Better Foam Caddis	66
Wild Turkey Baetis	101
Kinsey™, Lee	
Parachute Hi-Vis	78

Kintz™, Tom	
Major Bunker	60, 62, 183, 195
Major Herring	183, 195
Major Mullet	183, 195
Knowles™, David	
Y2K	138
Kraft™, Chuck	
Clawdad Kraft	54
Crittermite Kraft	54
Kreelex Minnow	55, 158
Lane™, Danny	
DJL Drake, Lane's	70
Laraway™, Andrew	
Ginger Snap	108, 131
Lawson™, Mike	
Brown Drake-Paradrake	70
Brown Drake Standard	70
Caddis Emerger	96
Cripple Dun	97
E-Z Caddis	72
Electric Caddis	107
Electric Caddis TB	107
Extended Body Brown Drake	70
Extended Body Green Drake	70
Foam Beetle	89
Green Drake Standard	70
Green Drake-Paradrake	70
Halfback Emerger	98
Hemingway Caddis	74
Henry's Fork Foam Stone	74
Henry's Fork Yellow Sally	74
Hi-Vis Foam Beetle	89
No Hackle	77
PMD	79
Spent Partridge Caddis	82
Thorax	83
LeCount™, Dan	
Picky Fish Damsel	149
Leister™, Andy	
Remote Control Soft Hackle	121
LeMay™, Bob	
Big Eye Tarpon	188
Black Death	188
Pike/Tarpon Snake	62, 188
Logan™, Bill	
Ant Misbehavin'	86
Big Secret Cricket	90
Big Secret Hopper	90
Lovejoy™, Brad	
Lovejoy's™ Cicada	93
Maktima™, Norman	
HDA Fav Variant	108, 131
ICU Midge (Tungsten)	98, 108, 131
Low Water Baetis	76
Perdichingons	114, 133
Maldonado™, Steve	
Jungle Junkie	60

Maldo's Emerger	99
Maldo's Trico	99
Mathews™, Craig	
Bonefish Bitters	174
Foam Spinner	73, 80
Gizmo Soft Hackle	121
Gray Drake Foam Spinner	80
Hi-Vis Rusty Spinner	80
Improved Sparkle Dun	71, 79, 101
Iris Caddis	75
Longhorn Beetle	89
Micro Beeley	121
Skittering Zelon Midge	100
Sparkle Dun	71, 79, 150
Three Dollar Dip	124
X Caddis	83
X2 Caddis	83
Zelon Midge Improved	101
Mayer™, Landon	
Candy Shop Callibaetis	67, 146
Chubby Damsel	146
Hot Head Mini Leech	148
Mayer's™ Mini Leech	58, 148
Mini Leech Jig	148
Mini Leech Jig Damsel	148
Mini Leech Jig Radiant	133, 148
Mayer's™ Mysis	142
Sink It Spinner	80, 171
Tails Up Trico	81
Titan Tube Midge	101, 150
Mayfield™, Ron	
Rattle Mullet	184, 196
McCannel™, Matt	
Demon Midge	97
Hell Razor Craw	108, 158
Hell Razor Leech	108, 148
Massacre Midge	99
Mighty Midge	99
Neon Nightmare	100, 113
McGovney™, Michael	
Simple Crab	178
McKnight™, Doug	
Crimp	176
Danger Muffin Crab	176
ER Crab	176
Rasta Puff	178
Sweetgrass Hopper	91
Thunder Grass Hopper	91
McLellan™, Michael	
Hunchback Scud	142
Hunchback Scud UV	142
Mena™, Brandon	
Cousin It Sculpin Jig	157
Double Fuego	157
Slider Bugger	155, 160
Mercer™, Mike	
Biot Epoxy Stone Nymph	104

Biot Epoxy Stone Jig	104, 129
Flush Floater Stone	72
Foam October Caddis Skater	72
Foam Parachute	72
Gold Bead Poxystack PMD	108
Jiggy Caddis Pupa	111, 132
Jiggy Drake	109, 132
Jiggy Micro May	111, 132
Jiggy PMD Nymph	111, 132
Jiggy Scud	132, 142
Jigster	111, 132
Micro Crayfish	55, 58, 113
Micro Mayfly Nymph	113
Micro Mayfly (Tungsten)	113
Micro Stone Nymph	113
Micro Stone Nymph (Tungsten)	113
Micro Stone Tungsten	113
Missing Link	77
Missing Link Caddis	77
Missing Link Honey Ant	87
October Caddis	64, 114
Poxystack	114
Poxystack Biot Stone	115
Poxystack Brass Bead	114
Poxystack Callibaetis	149
Poxystack Emerger	100
Profile Green Drake	70
Profile Spinner	80
Psycho Prince (Tungsten)	118
Psycho Prince	118
Psycho Prince Jig	119, 133
Rag Hex	59, 120, 166, 207
Skwala Stone Tungsten	122
Stealth Link	82, 150
Swing Caddis (Tungsten)	121
Swing Nymph (Tungsten)	121
Trigger Nymph	124, 150
Tungsten Pheasant Tail Prince	119
Z-Wing Caddis	126
Z-Wing Caddis (Brass bead)	126
Z-Wing Caddis (Tungsten)	126
Merriman™, Gary	
Tarpon Toad (Rabbit Strip Tail)	188
Tarpon Toad II (Marabou Tail)	189
Messinger™, Joe	
Messinger's™ Frog	57
Miller™, Brad	
Span Juan Worm	140
Miller™, Dennis	
Candy Cane Mysis	142
D-Midge	97, 107
Miller™, Mark (Pops)	
Pops Bugger	149, 154
Mills™, Josh	
The Roadrunner	164
The Studler	165
Mills™, Tyler	
Cowbell Cray	54, 157

Moret™, Sandy	
Sandy's Cracked Crab	178
Morgan™, Craig/ Larsen™, Eric	
Morgan's™ Midge	99
Morgan's Para-Midge	99
Murdich™, William	
Murdich™ Mini Minnow	55, 159, 160, 183, 195
Murdich™ Minnow 55, 160, 184, 195	
Murdich™ Minnow Marabou	195
Murdich™ Wiggler	55, 62, 160, 166, 177, 195
Murray™, Harry	
Flying Beetle	88
Mr. Rapidan	77
Shenandoah Chugger	57
Shenandoah Popper	57
Neal™, Timothy	
Para Spinner	80
Skopper	79, 91
Nealley™, Alan	
Brown Drake	70
Green Drake	70
Hex Adult	74
Nemes™, Sylvester	
Soft Hackle	121
Newman™, Scott	
Antifreeze Caddis	104, 128
Micro Matcher	113
Stunted Sally	123
Olch™, Jonathan	
Wiggle Lemming	161, 168
Oliverio™, Frank	
Crystal Wing Spinner	80
Evergreen Coffin Fly	72
Evergreen Eastern Green Drake	70
Olsen™, Devin	
Back Flop	129, 156
Blowtorch	104, 129
Diabaetis Perdigon	107, 130
Front End Loader	73, 131
Lite Brite Perdigon	112, 132
Quilldigon	115, 133
Space X Nymph	122, 134
Ortiz™, Travis	
Half-Man Intruder	164
Ouelette™, Doug	
Peaches & Cream	114, 133
Stone Daddy	123
Strawberries & Cream	123, 134
Sweet Pea	124, 134
Owens™, Brian	
Baby Bass Popper	56

Panazarella™, Luke	
Electric Slider	176
Flashback Shrimp	176
Laser Minnow	177
Paramore™, Eric	
Fancy Pants Hopper	90
Thunder Thighs Hopper	91
Parrot™, Steve	
Devil Jig	107, 130
Euro Jig Nymph	107, 130
Passage™, Chris	
Magic Fly	99
Magic Fly Tungsten	99, 112
Paulson™, Eric	
Flutter Bug	72
Pederson™, Matt	
401K Baetis	66
Pederson's Showbug	142
Peterson™, Tracy	
Bat Wing Emerger	96
Pettine™, Eric	
Eric's Midge (Hi-vis)	98
Lucky Charm, Pettine's™	112
Pettis™, Jim	
Unreal Egg	138
Phares™, David	
Caddis Candy	105
Pilgreen™, J.J.	
Dolly Llama	157, 166
Dolly Llama Mini	157, 166
Dolly Llama with Egg	157, 166
Potter™, Dennis	
Fat Head Beetle	88
Fat Head Beetle 2.0	88
Fat Head Moth	93
Lighthouse Spinner	80
October Caddis	77
Pearl and Elk Caddis	78
Potter's™ Pearl Butt Trico Spinner80	
Price™, Kevin	
Nosepicker	114
Puterbaugh™, Don	
Foam Caddis	72
Foam Stone	73
Quigley™, Bob	
Cluster	68, 97
Crime Scene Caddis	69
Film Critic	72, 98, 147
Glitter Ant Flag	87
Hackle Stacker	74
Sparkle Flag	82
Split Flag	82, 100
Stacked Sally	82
Reed™, Tyler	
Magma Mysis	142

Reid™, Clark	
Clark's Cicada	92
Rendle™, Steven	
Majestic AF	70, 76
Reynolds™, Barry	
Barry's Carp Bitter	58
Barry's Carp Fly	58
Barry's Pike Fly	62
Reynolds™, Nate	
San Juan Flash Worm	140
Roberts™, Daniel	
Good Friday Shad	183
Pop's Shad	184
Pop's Shad HD	184
Robertson™, Scott	
Scott's Damsel	150
Scott's Damsel Bugger	150
Robins™, Bryan	
Get Down Worm	140
Rodrigues™, Antonio	
Antonio's Adult	66, 128
Antonio's Emerger	96, 128
Antonio's Quill Midge	96, 129
Antonio's Superman Caddis	66, 129
Spanish Perdigon	122, 134
Rosenthal™, Matt	
Shagadelic Mop	122
Russell™, Paul	
Pablo's Cripple	78
Sands™, Will	
Epoxy Mysis Shrimp	142
Schlotter™, Jack	
Foam Flying Ant	87
Rogue Foam Stone	79
Schrantz™, Chris	
Callibaetis Nymph	106, 146
Platte River Spider	160, 164
Schroeder™, Ed	
Bubba's Callibaetis Nymph	105, 146
Hi-Vis Ant	87
Parachute Ant	87
Parachute Hopper	90
Sexton™, Mike	
Black Velvet	104, 129
Sexton's™ Booby	150
The Gunch	83
Tungsten Carotene Jig	124, 135
Shanafelt™, Pete	
Carpet Bug	142
Shimazaki™, Ken	
CDC Ant	87
Silvey™, Brian	
Balanced Sculpin	156
Chubby Sally	68
Fast Water Drake	70

Little Olive Stone Skwala	75
Mr Silvey	164
Pupa	115
Sculpin Leech	160
Silvey Intruder	165
Silveyator	165
Super Sink	123
Yellow Sally	83
Skok™, David	
Flashfire Mushy	60, 62, 195
Mushmouth	183, 196
Mushmouth Mini	184, 196
Strong Arm Merkin	178
Whitebait Mushy	185, 197
Sloan™, David	
Little Black Sloan™	112
Little Yellow Sloan™	112
Outrigger Caddis	78
Outrigger Yellow Sally	78
Smitherman™, Josh	
Draggin' Nymph	147
Immortal May	109
Masshopper	90
Massicada	93
Mountain Lobster	55, 158
Pint Caddis	78
Pint Hopper	90
Twisted Caddis	123
Twisted Crane	125
Twisted Damsel	151
Twisted Stone	125
Twisted Worm	135, 140
Spillers™, Ryan	
Bumble Butt Bee	92
Stachelek™, Ray	
Captain Ray's™ Silversides	182, 194
Stewart™, Jim	
Dancing Frog	56
Stout™, Carl	
Carl's Cicada	92
Carl's Foam Flying Ant	86
WD-50	101, 126
Streb™, Bob	
Lazy J Stone Jig	112, 132
Student™, Dave	
Cocktail PT	116
Fishalicious	182, 195
Megalopsicle	188
Takahashi™, Rick	
Tak's Crystal Chironomid	101, 150
Tak's Egg Laying Caddis	83
Tak's Mini Minnow	161
Takahopper	91
Thalcken™, Morgan	
Cruiser	54, 60, 62, 182, 194
Double Dutch Bug	69
Tiny Dancer	165

Tharrett™, Gordon	
GT Triple Double	74
Thompson™, Scott	
Lil Foamy (Tungsten)	98, 112
Thurman™, Zack	
Balanced Swimming Leech	146
Balanced Zack Attack Damsel	146
Cut Bait Midge	97, 106, 146
Jig Nation	111, 131
Pyramid Beach Leech	149
Zack Attack Damsel	151
Tokach™, Zachary	
TL Hopper	124
Znail	151
Turck™, Guy	
Power Ant	87
Vandehey™, Zach	
Bizzaro Jerry	104, 129
Picky Eater Perdigon	114, 133
Van Woert™, Josh	
Josh's Cosmic Crane	75
Veverka™, Bob	
Captain Crabby	174
Ghost Shrimp	176
Mantis Shrimp	177
Shinecock Silversides	184, 196
Spawning Mantis	178
Wade™, Tim	
North Fork Special	114
Watts™, Cliff	
Kilowatt	164
Winkler™, Matt	
Balanced Leather Leech	146
Kamikaze Sculpin	158
Sparring Partner	160
White™, Jeff	
Akobe Fly	54, 156, 194
Floating Wet	72
Foam Gut Minnow	188
SLG Minnow	160, 196
Whispell™, Frank	
Fish Whacker	157
Fish Whacker Mini	157
Weilenmann™, Hans	
CDC & Elk	67
Wilcox™, Vince	
JC Special	75
Little Green Machine	112
Wyatt™, Eddie	
Kung Fu Crab	177
Yankanich™, John	
Yank's Assassin	179, 185, 197

Yeager™, Jason

409	60, 86
Crack Back	100
Neversink Caddis	71
Neversink Sally	71
Point Guard Beetle	83
Soft Hackle J	115

Zimmerman™, Jay

Backstabber	52
Ball Peen Craw	48, 52
Chili Pepper Worm	182
Geezus Lizard	48, 152

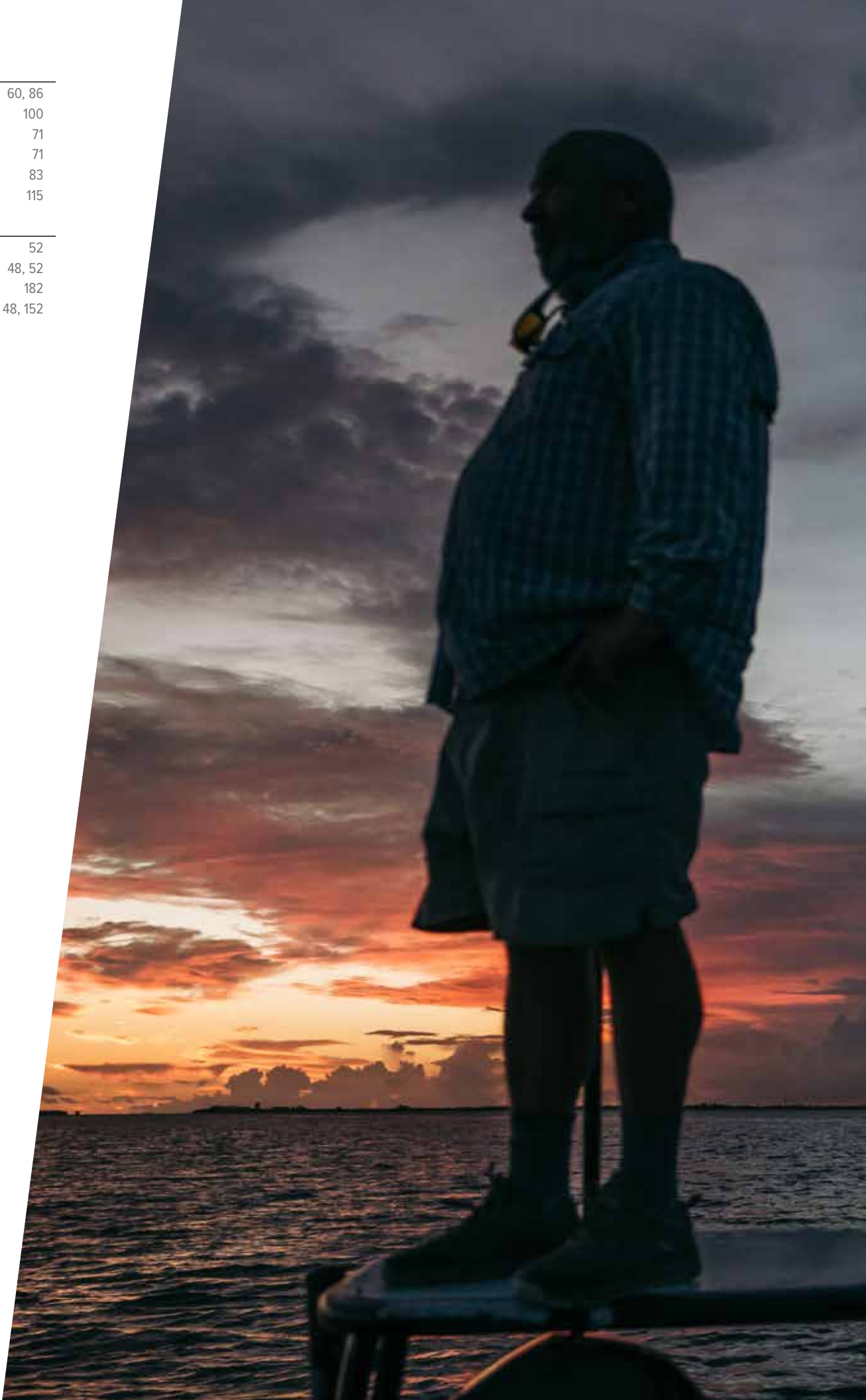



GENERAL FLY INDEX

2-Salt Tube	164	BC Streamer, Johnson's™	129, 156	Bonefish Scampi (Lead Eye), Cowen's™	174	CDC Cased Caddis Jig, Dorsey's™	106, 130
20 Incher	104	BDE Extended Body	66	Bonefish Slider	174	CDC Emerger	96
20 Incher (Tungsten)	104	Bead Head Egg (Barbless), Gorman's™	138	Borden Special	164	CDC Flashback PT, Kaufmann's™	115
20 Incher Jigged (Tungsten)	104,128	Bead Head Emerger, Barr's™	96	Bouface, Brass Bead, Barr's™	58, 72, 146	CDC Green Drake Emerger	96
401K Baetis, Pederson's™	66	Bear's Crossdresser, Andrews™	156, 166	Boy Wonder Hopper, Craven's™	90	CDC Green Drake Parachute	70
409, Yeager's™	66, 92	Bear's Hi-Viz Borcher Moosetail, Andrews™	66	Brassie	105	CDC Stone, Craven's™	106
64 Impala, Grillos™	66	Bear's Hi-Viz Brown Drake, Andrews™	70	Bread N' Butter Bugger, Collier's™	154	Challenged	96
Adams	66	Bear's Saddleback Hex, Andrews™	104, 166	Breadcrust Jig, Dorsey's™	105, 129	Charlie Boy Hopper, Craven's™	90
Adams Superfly	66	Bearded Baetis, Baxter's™	104, 129	Brown Drake, Nealley's™	70	Charlie's Mysis, Craven's™	142
Adult Damsel	66, 146	Bennett's™ Lunch \$	54, 156	Brown Drake Standard, Lawson's™	70	Chernobyl Ant	87, 92
Adult Damsel, Burk's™	66, 146	Better Foam Caddis, Kingrey's™	66	Brown Paradrake, Lawson's™	70	Chernobyl Crab	174
Adult Midge	96	Bi-wing Drake, Howard's™	70	Bubba's Callibaetis Nymph, Schroeder's™	105, 146	Chewy's Bender, Chouinard's™	174
Adult Wiggle Damsel	146	Big Eye Tarpon, LeMay's™	188	Buckskin Caddis	105	Chewy's Chewceiver, Chouinard's™	174
Akobe Fly, White's™	54, 156, 194	Big Fat Angie, Craven's™	92	Buckskin Jig, Dorsey's™	105, 129	Chewy's Cyborg Shrimp, Chouinard's™	175
Alphlexo Crab, Gerbec's™	174	Big Fat Ant, Johnson's™	86	Bumble Butt Bee, Spiller's	92	Chewy's Cyclops, Chouinard's™	175
Amy's Ant, Dennis™	66, 92	Big Fish Deceiver	60, 62, 182, 194	Bumpin Bunny, Alexander's™	188,	Chewy's Fit For a King , Chouinard's™	188
Anato-May,	104	Big Secret Cricket, Logan's™	90	Bunny Gotcha	174	Chewy's Halo Shrimp, Chouinard's™	175
Ant Misbehavin', Logan's™	86	Big Secret Hopper, Logan's™	90	Bunny Leech	146, 164	Chewy's Island Time, Chouinard's™	175
Antifreeze Caddis, Newman's™	104, 128	Bionic Ant, Egan's™	86, 129	Caddis Candy, Phare's™	105	Chewy's Minnr, Chouinard's™	175
Antonio's Adult, Rodrigues™	66, 128	Bionic Ant 2.0, Egan's™	86 129	Caddis Emerger, Lawson's™	96	Chewy's Morsel, Chouinard's™	175
Antonio's Emerger, Rodrigues™	96, 128	Biot Epoxy Stone Nymph, Mercer's™	104	Cadds Larva steelhead	207	Chewy's Tarponator , Chouinard's™	188
Antonio's Quill Midge, Rodrigues™	96, 129	Biot Epoxy Stone Jig, Mercer's™	104, 129	Caddis Larva	105	Chili Pepper Worm, Zimmerman's™	188
Antonio's Superman Caddis, Rodrigues™	66, 129	Biot Mayfly Emerger,	96	Caddis Larva BH	105	Chironomid Bomber	96, 146
Atomic Stone, Hudspeth's™	104	Biot Midge Emerger,	96	Caddis Poopah, Fox's™	105	Chironomid Pupa	96, 146
Attract-Ant	86	Bird's Nest	104	Caddis Poopah Brass Bead, Fox's™	105	Chloris Leechman, Thanken's	184, 194
Autumn Splendor, Heng's™	154	Bird's Nest Brass Bead	104	Caddis Variant	66	Christmas Island Special, Kaufmann's™	175
Avalon Permit Fly	174	Bishop's™ Dynamite	104, 129	Caddistrophic Pupa, Craven's™	106	Choker, Hieronymus™	138, 166
B/C Dropper Hopper, Barr/Craven's™	90	Bizzaro Jerry, Vandehey's™	104, 129	Cahill	67	Chubby Chernobyl	68, 92
Baby Bass Popper, Owen's™	56	Black & Orange, Hogans™	164	Caleb's Bee, Boyle's™	92	Chubby Cubby, Davidson's™	87
Baby Boy Hopper, Craven's™	90	Black Back Emerger, Barr's™	96	Callibaetis Nymph, Schrantz™	106, 146	Chubby Damsel, Mayer's™	146
Back Flop, Olsen's™	129, 156	Black Beauty, Dorsey's™	96	Callibaetis Spinner, A.K.'s™	80, 146	Chubby Norman	68
Backstabber, Zimmerman's™	58	Black Beauty Flashback, Dorsey's™	96	Candy Cane Mysis, Miller's™	142	Chubby Sally, Silvey's™	68
Bad Additude Bait, Caranci's™	194	Black Beetle	88	Candy Shop Callibaetis, Mayer's™	67, 146	Chubby Trico Spinner	80
Baetis Nymph (Tungsten)	129	Black Death	188	Cannon's™ Worm	140	Chuckwagon, C. Johnson's™	156
Balanced Leather Leech, Winkler's™	146	Black Dress, Hogan's™	164	Captain Crabby, Veverka's™	174	Chrome Chironomid	97, 140
Balanced Sculpin, Silvey's™	156	Black Gnat	66	Captain Gregg, Hochner's™	174	Circus Peanut	156
Balanced Swimming Leech, Thurman's™	146	Black Velvet, Sexton's™	104, 129	Captain Ray's Silversides, Stachelek's™	182, 194	CK Nymph , Kraft's™	130
Balanced Zack Attack Damsel, Thurman's™	146	Blind Faith Merkwán, Janik's™	174	Carl's Cicada, Stout's™	92	Clark's Cicada, Reid's™	92
Ball Peen Craw, Zimmerman's™	54, 58	Blindside Midge, Easdon's™	96	Carl's Foam Flying Ant, Stout's™	86	Clawdad, Kraft's™	54
Ballok's™ Big Boy	62	Blowtorch, Olsen's™	104, 129	Carpenter Foam Ant	86	Clear Wing Spinner Brown Drake, Andrews™	80
Banger	60, 182, 191	Blue Wing Olive	66	Carpet Bug, Shanafelt's™	142	Clear Wing Spinner Hex, Andrews™	80
Bantam	164	Boatman, Theo's™	146	Cathy's Fleeing Crab, Beck's™	174	Clear Wing Spinner Trico, Andrews™	80
Barr's™ Uncased Caddis	108	Boobie Crab, Hochner's™	174	CBD Nymph Jig	105, 130	Clouser Crayfish	54
Barry's Carp Bitter, Reynolds™	58	Bone Appetite, Chicone's™	174	CDC & Elk, Weilenmann's™	67		
Barry's Carp Fly, Reynolds™	58	Bonefish Bitters, Mathews™	174	CDC Ant, Shimazaki's™	87		
Barry's Pike Fly, Reynolds™	62	Bonefish Deep Minnow	58, 174	CDC Biot Spinner	80, 146		
Bass Popper	56	Bonefish Junk, Craven's™	174	CDC Callibaetis Nymph, deGala's™	106, 146		
Bat Wing Emerger, Peterson's™	96	Bonefish Scampi (Bead Chain), Cowen's™	174				

Clouser Minnow	60, 62, 156, 182, 194	Czech Bomb	106, 130	Electric Caddis, Lawson's™	107	Flying Loco Beetle	88
Clouser Minnow Baby Small Mouth	54	D-Midge, D. Miller's™	97, 107	Electric Caddis Tungsten Bead, Lawson's™	107	Foam Beetle, Lawson's™	89
Clown Egg	138	Damsel, Barr's™	146	Electric Slider, Panzarella's™	176	Foam Caddis, Puterbaugh's™	72
Cluster, Quigley's™	68, 97	Damsel, Burk's™	147	Elk Caddis	72	Foam Dragon	53, 161
Cockroach	188	Damsel Adult	147	Elk Caddis, Hot Wing	72	Foam Flying Ant, Schlotter's™	87
Cocktail Pheasant Tail, Student's™	116	Dancin' Ricky, Grillos™™	69	Emerger (Wet), Barr's™	97	Foam Gut Minnow, White's™	188
Colonel Kurtz, Z. King's™	157	Dancing Frog, Stewart's™	56	Epoxy Mysis Shrimp, Sand's™	142	Foam Hopper	90
Colorado Green Drake	70	Danger Muffin Crab, Mcknight's™	176	ER Crab, McKnight's™	176	Foam October Caddis Skater, Mercer's™	72
Comparadun	68	Dark Back Emerger, Barr's™	97	Eric's Midge (Hi-Vis), Pettine's™	98	Foam Parachute, Mercer's™	72
Comparadun CDC Biot	68	Dark Lord, Hart's™	118	Euro Jig Nymph, Parrott's™	107, 130	Foam Spinner, Mathews™™	73, 80
Conehead JJ Special	154	Darth Baetis, Garcia's™	107	Evergreen Coffin Fly, Oliverio's™	72	Foam Stone, Puterbaugh's™	73
Contraband Crab, Chicone's™	176	Dave's Hopper	90	Evergreen Eastern Green Drake, Oliverio's™	70	Formerly Prince	118
Copper John, Barr's™	106	DC Prawn, Hogan's	164	Extended Body Brown Drake, Lawson's™	70	Freaky Frog	57
Copper John Jig, Barr's™	106	Dead Drift Crayfish, Haddon's™	54, 107	Extended Body Green Drake, Lawson's™	70	Frenchie, Egan's™	108, 131
Corn-Fed Caddis (CDC), Egan's™	68, 130	Deceiver	62, 182, 194	Fancy Pants Hopper, Paramore's™	90	Frenchie Chironomid, Egan's™	131, 147
Corn-Fed Caddis (CDC Rubberlegs, Egans™)	68, 130	Deep Cleaner, Bond's™	107, 130	Fast Water Drake, Silvey's™	70	Frenchie Jig, Egan's™	108, 131
Corn-Fed Sally (CDC), Egan's™	68, 130	Deep October Pupa	107, 166	Fat Angie, Craven's™	93	Front End Loader, Olsen's™	73, 131
Corn-Fed Spruce Moth, Egan's™	68	Deer Hair Ant	87	Fat Head Beetle, Potter's™	88	Frostbite Chironomid	98, 124, 147
Cousin It Sculpin Jig, Mena's™	157	Deerhair Bass Bug (Weedless)	56	Fat Head Beetle 2.0, Potter's™	88	Fur Ant	87
Cow Killer Ant	87	Demon Midge, McCannel's™	97	Fat Head Moth, Potter's™	93	Fusion Nymph, Reece's™	133
Cowbell Cray, Mills™™	54, 157	Desert Storm (Glass Bead), Gomez™	97	Fight N Flee Fiddler, Janik's™	176	Fusion Nymph Rubberlegs, Reece's™	115
Cowen's™ Baitfish	182, 194	Detroit Mop City, Eakin's	58	Film Critic, Quigley's™	72, 98, 147	Game Changer	54, 60, 62, 158, 183, 195
Coyote, Cowen's™	54, 182, 194	Devil Jig, Parrott's™	107, 130	Fish Taco, Hickman's™	164	Geezus Lizard, Zimmerman's™	48, 158
Coyote Spawn Shrimp, Chicone's™	176	Diabaetis Perdigon, Olsen's™	107, 130	Fish Whacker, Whispell's™	157	Get Down Worm, Robin's™	140
Coyote Shrimp, Chicone's™	176	Dirty Bird	107	Fish Whacker Mini, Whispell's™	157	Ghost Shrimp, Veverka's™	176
Crack Back, Yeager's™	106	Dirty Bird (Tungsten)	107	Fishalicious, Student's™	182, 195	Ginger Snap, Laraway's™	108, 131
Crafty Shrimp (Bead Chain), Bauer's™	176	Dirty Frig, Huffman's™	53	Flash-A-Bugger Brass Bead	154	Gizmo Soft Hackle, Mathews™™	121
Crane Fly Larva, Barr's™	106	Dirty Hairy, Hochner's™	176	Flashback Emerger, Barr's™	98	Glades Minnow, Conner's™	177, 195
Crazy Charlie	176	Dirty Hippy, Craven's™	157	Flashback Hare's Ear	110	Glitter Ant Flag, Quigley's™	87
Crease Fly, Blados™™	56, 60, 182, 191, 194	Disco Midge	97	Flashback Pheasant Tail	116	Goat Leech	148
Creek Crawler, Hada's™	54, 106	Disco Shrimp, Chicone's™	176	Flashback Pheasant Tail (Bead Head)	116	Goddard Caddis	73
Creek Leech, Johnson's™	157	Ditch Witch, Jackson's™	157	Flashback Pheasant Tail (Tungsten)	116	Gold Bead Hare's Ear	110
Crime Scene Caddis, Quigley's™	69	Diving Bug (Weedless), Dahlberg's™	56	Flashback Shrimp, Panzarella's™	176	Gold Bead Poxback PMD, Mercer's™	108
Crimp, McKnight's™	176	DJL Drake, Lane's™	70	Flashfire Mushy, Skok's™	60, 62, 195	Gold Ribbed Hare's Ear	110
Cripple Dun, Lawson's™	97	Dolly Llama, Lane's™	157, 166	Flashtail Mini Egg	138	Gold Ribbed Hare's Ear (Tungsten)	110
Crittermite, Kraft's™	54	Dolly Llama Mini, Pilgreen's™	157, 166	Flashtail Minnow Jig, Blanton's™	182, 188	Golden Nugget, Graffam's™	108, 131
Cruiser, Thalken's™	54, 60, 62, 182, 194	Dolly Llama w/Egg, Pilgreen's™	157, 166	Flat Head Cicada	93	Golden Stone Barred Leg	73
Crystal Bugger, Brass Bead	154	Dorsey's™ UV Scud	142	Flats Crab	176	Good Friday Shad, Robert's™	183
Crystal Bugger Brass Bead Rubberlegs	154	Double Dirty Hippy, Craven's™	157	Flats Crab Mottled	176	Gonga, Baby, Craven's™	158
Crystal Bugger Jig	154	Double Dutch Bug, Thalken's™	69	Flav Spinner	80	Gonga, Double, Craven's™	158
Crystal Damsel Dragon	56	Double Fuego, Mena's™	157	Flesh Fly	166	Gotcha	177
Crystal Hunchback Brass Bead, Burk's™	106	Draggin Nymph, Smitherman's™	147	Flexy Stone, Doctor's™	107	Gotcha (Weedless)	177
Crystal Hunchback Tungsten Bead, Burk's™	106	Dragon, Bond's™	157	Floating Smelt	56, 157	Graphic Caddis, Barr's™	108
Crystal Wing Spinner, Oliverio's™	80	Dragon Mini, Bond's™	157	Floating Wet, White's™	72	Gray Drake Foam Spinner, Mathews™™	80
Cupboard Ant, Davidson's™	87	Drowned Spinner, Barr's™	80	Flush Floater Stone, Mercer's™	72	Gray Ghost	158
Cut Bait Midge, Thurman's™	97, 106, 146	Drum Beater, Davis™™	176	Flutter Bug, Paulson's™	72	Great Carpholio Jig, Grillos™™	58
CZ Caddis (Tungsten), Cotter's™	106, 130	Drunken Suzy, Craven's™	69	Fluttering Stone	72	Green Butt Silver Hilton	164
		Duracell Bomb	107, 130	Flying Ant	87	Green Butt Skunk	164
		E/C Caddis, Cutter's™	69	Flying Beetle, Murray's™	88		
		E-Z Caddis, Lawson's™	72				
		Egg Sucking Crystal Leech	154, 166				
		Egg Sucking Leech	166				
		Eggs (TMC 105)	138				
		El Camino, Grillos™™	69				

Green Drake, Nealley's™	70	Hot Belly Pheasant Tail	116	Jungle Junkie, Maldonado's™	60	Masshopper, Smitherman's™	90
Green Drake-Paradrake, Lawson's™	70	Hot Head Mini Leech, Mayer's™	148	Jungle Love	60	Massicada, Smitherman's™	93
Green Drake Nymph, Yeager's™	115	Hot Wired Prince (Tungsten)	118	Ka-Cudda	195	Matchstick Quill Jig	112, 132
Green Drake Parachute	70	Hotwire Caddis	108	Kamikaze Sculpin, Winkler's™	158	May Day	76, 148
Green Drake Standard, Lawson's™	270	Hud's Bushwhacker, Hudspeth's™	55, 62, 158, 195	Key's Toad	188	Mayer's™ Mysis	142
Griffith's Gnat	73	Hula Damsel, deGala's™	148	Kilowatt, Watt's™	164	Mayhem Jig, Kelso's™	113, 132
Griffith's Gnat, Hi Vis	74	Humpy	75	King Prince (Tungsten)	118	Mayhem Mole Crab, Chicone's™	177
GTI Caddis, Egan's™	108	Hunchback, (Infrequens) Burk's™	108	King Rat Small, Chicone's™	57, 168	Mayport Select Shrimp, Janik's™	177
GT Triple Double, Tharett's™	74	Hunchback Green Drake, Burk's™	108	Kreelex Minnow, Kraft's™	55, 158	McCrab, Anderson's™	177
Guide's Choice Hare's Ear	110	Hunchback Scud, McLellan's™	142	Kung Fu Crab, Wyatt's™	177	Meat Whistle, Barr's™	55, 158, 166
Guide's Choice Hare's Ear (Tungsten)	110	Hunchback Scud, UV, McLellan's™	142	Kwan (Bead Chain), Dorsy's™	177	Medallion Midge Pupa, Dorsey's™	99
Gulper Special	74	Hunchback Two-Tone, Burk's™	108	Laid-Up Tarpon	188	Megalopsicle, Student's™	188
Gummy Minnow	55, 158, 177, 183, 195	Hustler CDC, Graffam's™	108, 131	Laser Minnow, Panzarella's™	177	Melon Quill, A.K.'s™	76
Gummy Minnow Big Game	183, 188, 195	HVRT Carp Fly, Eakins™	58	Last Gasp Ant, Iwane's™	87	Mercury Flashback Pheasant Tail, Dorsey's™	116
Gummy Tarpon Worm	188	Ice Cream Cone	98, 148	LED Chironomid, Davidson's™	148	Mercury Series, Dorsey's™	99, 113
Gunnison Green Drake, Fowler's™	270	ICU Midge (Tungsten), Maktima's™	98, 108, 131	LED Midge, Davidson's™	98	Mercury SH Pheasant Tail, Dorsey's™	113, 116
H & L Variant	74	Immortal May, Smitherman's™	109	Lexo's Pop Up Crab, Hochner's™	177	Messenger's™ Frog	57
Hackle Stacker, Quigley's™	74	Improved Merkin	177	Lil Foamy Tung, Thompson's™	98, 112	Meth Egg	138
Hairwing Drake	70	Improved Pheasant Tail, Chouinard's™	98, 116	Lil Froggy, Takahashi's™	53	Micro Beeley, Mathew's™	121
Hairwing Dun	70, 74	Infernogons	109, 131	Lil' Kim	158	Micro Crayfish, Mercer's™	55, 58, 113
Hairwing Yellow Sally	74	Iris Caddis, Mathews™	75	Lighthouse Spinner, Potter's™	80	Micro Egg (Weighted)	138
Half-Man Intruder, Ortiz's™	164	Iron Lotus, Egan's™	109, 131	Lightning Leech, F. Dorsey's™	148	Micro Matcher, Newman's™	113
Halfback Emerger, Lawson's™	98	Iron Lotus Jig, Egan's™	109, 131	Limeade, Dorsey's™	75	Micro Mayfly (Tungsten), Mercer's™	113
Hamburgler, Grillos™	89	Iron Sally	109	Lite Brite Perdigon, Olsen's™	112, 132	Micro Mayfly Nymph, Mercer's™	113
Hare Sculpin	158	Iron Sally Jig	109, 131	Little Black Sloan, Sloan's™	112	Micro Popper	57
HDA Fav Variant, Maktima's™	108, 131	Iron Sally (Tungsten)	109	Little Green Machine, Wilcox's™	112	Micro Slider	57
Headlight Sally	74	Irresistible	75	Little Olive Stone Skwala, Silvey's™	75	Micro Spawn	138
Headstand, Egan's™	58	Iwan-e-Dun Para, Iwane's™	75	Little Yellow Sloan™	112	Micro Stone (Tungsten), Mercer's™	113
Helgramite	108	Japanese Beetle	89	Little Yellow Stone (Female)	75	Micro Stone Nymph, Mercer's™	113
Hell Razor Craw, McCannel's™	108, 158	JC Special, Wilcox's™	75	Little Yellow Stonefly, Cutter's™	76	Micro Stone Nymph (Tungsten), Mercer's™	113
Hell Razor Leech, McCannel's™	108, 148	Jeffrey Dauber, Craven's™	93	Loco Mouse	57, 168	Midnight Minnow, Conner's™	55, 158, 177, 183, 195
Hemingway Caddis, Lawson's™	74	Jersey Turnpike	183, 195	Long Haired Hippie, King's™	112	Midnight Mullet, Conner's™	55, 177, 183, 195
Hendrickson	74	Jig Nation, Thurman's™	111, 131	Longhorn Beetle, Mathews™	89	Mighty Midge	99
Henry's Fork Foam Stone, Lawson's™	74	Jigged CDC Pheasant Tail	116, 125	Lovejoy's™ Cicada, Lovejoy's™	93	Military Mayfly	113
Henry's Fork Yellow Sally, Lawson's™	74	Jigged Green Drake, Hanner's™	109, 132	Low Water Baetis, Maktima's™	76	Mimic Hopper, C. Johnson's™	90
Hex Adult, Nealley's™	74	Jigged Hare's Ear Tungsten	110, 132	Lucky B, Craven's™	93	Mimic May, Johnson's™	76
Hex Adult (Deer Body)	74	Jigged Pheasant Tail Tungsten	127	Lucky Charm, Pettine's™	112	Mini Hankey, Hickman's™	168
Hex Paradrake, Quigley's™	71	Jigged Prince Tungsten	118, 132	Macgruber, Jackson's™	112	Mini Hippie Stomper, Grillos™	76
Hex Spinner	80	Jigged Drake, Mercer's™	109, 132	Madam X, Parachute	76	Mini Hot, Garcia's™	76
Hexagenia, Burk's™	108	Jiggy Caddis Pupa, Mercer's™	111, 132	Magic Fly, Passage's™	99	Mini Hot Mayfly, Garcia's™	76
Hi-Vis Ant, Schroeder's™	87	Jiggy Drake, Mercer's™	109, 132	Magic Fly Tungsten, Passage's™	99, 112	Mini Leech, Mayer's™	58, 148
Hi-Vis Flying Ant	87	Jiggy Micro May, Mercer's™	111, 132	Magma Mysis, Reed's™	142	Mini Leech Jig Damsel, Mayer's™	148
Hi-Vis Foam Beetle, Lawson's™	89	Jiggy PMD Nymph, Mercer's™	111, 132	Magnum Mantis, Chicone's™	177	Mini Leech Jig Radiant, Mayer's™	133, 148
Hi-Vis Rusty Spinner, Mathews™	80	Jiggy Scud, Mercer's™	132, 142	Mahony, Hogan's™	164	Mini Mopsicle, Horodysky's™	113, 133
Hippie Stomper, Grillos™	74	Jigster, Mercer's™	111, 132	Majestic AF, Rendle's™	70, 76	Mini Mouse (Weedless)	57, 168
Hipster Dufus, Eakins™	58	Josh's Cosmic Crane, Van Woert's™	75	Major Bunker, Kintz™	60, 62, 183, 195	Missing Link, Mercer's™	76
Hood Rat Articulated, Armstrong's™	168	Juju Baetis, Craven's™	111	Major Herring, Kintz™	183, 195	Missing Link Caddis, Mercer's™	77
Hot Bead Bugger	154	Juju Baetis Tungsten, Craven's™	111	Major Mullet, Kintz™	183, 195		
Hot Bead Jolly Rancher, Hanner's™	131, 148, 154	Juju PMD, Craven's™	111	Maldo's Emerger, Maldonado's™	99		
		Jujubee Midge, Craven's™	98	Maldo's Trico, Maldonado's™	99		
		Jujubee Midge Flash, Craven's™	98	Manhattan Midge, Dorsey's™	99		
		Jumbo Juju Chironomid, Craven's™	98, 148	Mantis Shrimp, Veverka's™	177		
		Juju Sally, Craven's™	111	March Brown, A.K.'s™	76		
				March Brown, Flick's™	76		
				March Brown Nymph	140		
				Massacre Midge, McCannel's™	99		

Missing Link Honey Ant, Mercer's™ 87	Outrigger Yellow Sally, Sloan's™ 78	Poxyback, Mercer's™ 114	RS-2 Emerger (Low Wing) 100
Mohawk Beetle, Horodysky's™ 89	Pablo's Cripple, Russell's™ 78	Poxyback Brass Bead, Mercer's™114	RS-2 Sparkle Wing 100
Mole Fly, Craven's™ 99	Para Damsel, Birchby's™ 78	Poxyback Biot Stone, Mercer's™ 115	RS-2 Sparkle Wing Radiant 100
Mole Midge, Craven's™ 99	Para Emerger, Befus™ 100	Poxyback Callibaetis, Mercer's™149	Rubber Leg Squirrel Nymph 122
Mop Brass 113	Para Spinner, Neal's™ 80	Poxyback Emerger, Mercer's™ 100	Rubberleg Copper John Steelhead, Barr's™ 166
Mopsicle Jigged, Horodysky™113, 133	Parachute 78, 149	Prince CDC 118	Rubberlegs 122
Morgan's Midge, Morgan/Larsen's™ 99	Parachute, A.K.'s™ 78	Prince Nymph 118	Rubberlegs Jig 112, 134
Morgan's Para-Midge, Morgan/Larsen's™ 99	Parachute Ant, Schroeder's™ 87	Prince Nymph (Bead Head) 118	Ruby-Eyed Leech 150
Morningwood Hopper, Craven's™ 90	Parachute Caddis 78	Prince Nymph (Tungsten) 118	Rusty Nail Perdigon, Drummond's™ 122, 134
Morningwood Special, Craven's™ 77	Parachute, Hi- Vis 78	Problem Child, Craven's™ 118	S&M Nymph 122
Mosquito 77	Parachute, Hi-Vis Adams 78	Profile Green Drake, Mercer's™ 70	Saltwater Popper 191
Mother's Day Caddis, Garcia's™ 77	Parachute Hopper, Schroeder's™ 90	Profile Spinner, Mercer's™ 80	Saltwater Popper Dorado, Bachmann's™ 191
Mother's Day Sally, Garcia's™ 77	Parachute Yellow Sally 78	Psycho Prince, Mercer's™ 118, 207	San Juan Flash Worm, Nate Reynolds™ 140
Mountain Lobster, Smitherman's™ 55, 158	ParaWulff, Dennis™ 70, 78	Psycho Prince Jig, Mercer's™119, 133	San Juan Worm 140
Mouserat (Weedless) 51, 168	Party Girl, Hieronymus™ 164	Psycho Prince Tungsten Rubberlegs, Mercer's™ 118	San Juan Worm, Theo's™ 140
Mr. Hankey, Hickman's™ 168	Pat's Bread Crust, Dorsey's™ 114	Punisher, Chicone's™ 188	San Juan Worm Gold Bead 140
Mr. Rapidman, Murray's™ 77	Pat's Midge, Dorsey's™ 100	Pupa, Silvey's™ 115	Sandy's Cracked Crab, Moret's™ 178
Mr. Jones, Craven's™ 77	Peaches & Cream, Ouelette's™114, 133	Pure Midge Larva, Barr's™ 100	Scandi Candy 165
Mr Silvey, Silvey's™ 164	Peacock Caddis 78	Purple Haze Emerger, Blessing's™100	Scott's Damsel, Robertson's™ 150
Muddler Minnow 159	Pearl and Elk (Caddis), Potter's™ 78	Purple Prince 119	Scott's Damsel Bugger, Robertson's™ 150
Murdich™ Mini Minnow 55, 159, 160, 183, 195	Pederson's Showbug, Pederson's™142	Pyramid Beach Leech, Thurman's™ 149	Scud, Kaufmann's™ 142
Murdich™ Minnow 55, 160, 183, 195	Perdichingons, Maktima's™114, 133	Quasimodo Pheasant Tail 117	Sculpin Leech, Silvey's™ 160
Murdich™ Minnow Marabou 195	Perminator, Hochner's™ 178	Quill Bomb 115, 133	Sea Habit Bucktail 60, 184, 196
Murdich™ Wiggler 55, 62, 160, 166, 177, 196	Permit Crab, Del Brown's™ 178	Quill Gordon 79	Seed Beetle, Feller's™ 89
Mushmouth, Skok's™ 183, 196	Peyote Palolo, Chicone's™ 188	Quilldigon, Olsen's™ 115, 133	Sexton's™ Booby 150
Mushmouth Mini, Skok's™ 184, 196	Pheasant Tail 116	Radiation Baetis, Gunkle's™ 115	Sexy Walts 122, 134
Mutant Stone 77	Pheasant Tail CDC 116	Rag Head Crab 178	Shagadelic Mop, Rosenthal's™ 122
Naked Chubby 77, 93	Pheasant Tail Flashback Slim 116	Rag Hex, Mercer's™59, 120, 166,207	Shenandoah Chugger, Murray's™ 57
Near Nuff Crayfish 55, 59	Pheasant Tail Nymph 116	Rainbow Warrior, Egan's™ 120	Shenandoah Popper, Murray's™ 57
Near Nuff Sculpin 55, 160	Pheasant Tail Nymph (Tungsten)117	Rainbow Warrior CDC Tungsten, Egan's™ 120, 133	Shincock Silversides, Veverka's™ 184, 196
Neon Nightmare, McCannel's™ 100, 113	Pheasant Tail Slim 117	Rainbow Warrior X-Hvy, Egan's™120, 134	Shotglass Baetis, Gunkel's™ 122
Net Builder Caddis, Barr's™ 114	Picky Eater Perdigon, Vandehey's 114, 133	Rasta Puff, McKnight's™ 178	Shotglass Emerger Dun, Gunkel's™ 122
Neversink Caddis, Yeager's™ 77	Picky Fish Damsel, LeCount's™ 149	Rattle Mullet, Mayfield's™ 184, 196	Sierra Damsel, Burk's™ 150
Neversink Sally, Yeager's™ 77	Pike/Tarpon Snake 62, 188	Ray Charles 142	Silhouette Dun, Burk's™ 79
Nick's Fat Caddass, Adler's™114, 133	Pine Squirrel Leech, Craven's™ 149	Razor Mayfly, Freed's™ 79	Sili-Squid Intruder 165
Nightmare Needle Fish, Chicone's™ 177	Pineapple Grenade Popper, Chicone's 57, 191	Red Ass 121	Sili Legs, Beck's™ 178
Nine LB Hammer, Craven's™154, 160	Pink Plerre, Hebert 114	Red Headed Step Child 120	Sili Legs Lite, Beck's™ 178
Nitro Caddis Pupa, Horodysky's™ 114	Pint Caddis, Smitherman's™ 78	Red Quill 79	Silver Bullet Baetis, Egan's™122, 134
No Hackle, Lawson's™ 77	Pint Hopper, Smitherman's™ 90	Redfish Scampi, Cowen's™ 178	Silvey Intruder, Silvey's™ 165
No Mercy Midge, Iwane's™ 100	Plan C Caddis, Hanner's™ 114, 133	Reducer, Rob Anderson's™ 60, 184, 196	Silveyator, Silvey's™ 165
No Name Damsel 148	Platte River Spider, Schrantz™ 160, 164	Remote Control Soft Hackle, Leister's™ 121	Simple Crab, McGovney's™ 178
North Fork Special, Wade's™ 114	PMD, Lawson's™ 79	Renegade 79	Sink It Spinner, Mayer's™ 80, 171
Northwoods Ninja, Ballok's™ 62	Po Boy, Gerbec's™ 178	Resting Caddis, Gerbec's™ 79	Sizzlin Hot Spot Squirrel 122
Nosepicker, Price's™ 114	Poacher, Egan's™ 133, 160	Restless Stone 120	Skiddish Smolt, Hickman's™160, 165
October Caddis, Potter's™ 77	Point Guard Beetle, Yeager's™ 89	Rio Bandito, Johnson's™ 120, 134	Skinny Water Clouser Minnow (Weedless) 160, 178, 196
October Caddis, Mercer's™ 64, 114	Poison Tung, Craven's™ 114	Rogue Foam Stone, Schlotter's™ 79	Skipper, Dahlberg's™ 57
October Caddis tung, Mercer's™ 142	Polar Prawn, Gerbec's™ 178	Rojo Midge, Garcia's™ 100	Skittering Zelon Midge, Mathews™ 100
October Caddis Adult 77, 166	Polyfluff Caddis, Beck's™ 79	Royal Coachman 79	Skopper, Neal's™ 79, 91
October Hilton 164	Pops Bugger, Miller's™ 149, 154	Roy's Special Emerger 100	
One Armed Bandit, Hochner's™ 178	Pop's Shad, Robert's™ 184		
Outrigger Caddis, Sloan's™ 78	Pop's Shad HD, Robert's™ 184		
	Potter's™ Pearl Butt Trico Spinner, Potter's™ 80		
	Power Ant, Turck's™ 87		

Skwala	79	Stunted Sally, Newman's™	123	Three Dollar Dip, Mathews™	124	Umpqua™ Pike Fly	60, 62
Skwala Stone, Mercer's™	122	Sulfur Dun	83	Thunder Grass Hopper, McKnight's™	91	Umpqua™ Swimming Baitfish	57, 60, 62, 185, 197
Snapshot Scud, Easdon's™	142	Summer Iron, Howard's™	165	Thunder Thighs Hopper, Paramore's™	91	Umpqua™ Swimming Frog	57
SLG Minnow, White's™	160, 196	Summer Stone, Freed's™	83	Tide Rider	165, 185, 196	Unreal Egg, Pettis™	138
Slider Bugger, Mena's™	155, 160	Super Bugger, Beck's™	59, 155	Tide Slave, Chicone's™	179	User Friendly, Grillos™	83
Slow Water Sally, Befus™	79	Super Pupa	123	Tilt Wing Dun	83	UV Juan, Anderson's™	140
Slump Buster, Barr's™	160	Super Sally, C. Johnson's™	83	Tim's 0351, Drummond's™	124	UV Sally, Anderson's™	126
Snook-A-Roo, Stewart's™	53, 213	Super Sinkers, Silvey's™	123	Tim's Beetle, Dummond's™	89	Vis-A-Dun, Barr's™	83
Soft Hackle, Nemes™	121	Superior Spruce Moth, Grillos™	83, 93	Tim's Beetle 2.0, Drummond's™	89	Waking Mouse	57, 168
Soft Hackle Emerger, Craven's™	100	Supreme Hair Rattle Shrimp, Haines™	188, 196	Tim's Stone, Drummond's™	124	Waking Mouse 2.0	57, 168
Soft Hackle J, Yeager's™	121	Supreme Hair Shrimp, Haines™	179, 196	Tiny Dancer, Thalken's™	165	Warrior Perdigon, Egan's™	126, 135
Soft Hackle Pheasant Tail (Tungsten)	121	Surf Candy	185, 196	Titan Tube Midge, Mayer's™	101, 150	WD-40, Engler's™	101, 126
Somethin Else, Cowen's	55, 191, 196	Sweet Pea, Ouellette's™	124, 134	TL Hopper, Tokach's™	91	WD-50, Stout's™	101, 126
Sow Chow, Davidson's™	142	Sweetgrass Hopper, McKnight's™	91	Todd's Wiggle Minnow, Boyer's™	57, 62, 161, 185, 191, 196	Wedge Head, Ginop's™	161
Sow Chow Tungsten, Davidson's™	143	Sweetmeat Caddis, Doctor's™	123, 134	Top Secret Baetis, Dorsey's™	124	Westside	179
Space Invader, Ron Anderson's™	55, 60, 184, 196	Sweetmeat Caddis Deep, Doctor's™	123, 134	Top Secret Midge, Dorsey's™	101	Whitebait Mushy, Skok's™	185, 197
Space X Nymph, Olsen's™	122, 134	Sweetmeat Sally, Doctor's™	124, 134	Trailing Shuck Midge	101	Wiggle Lemming, Olch's™	161, 168
Span Juan Worm, B. Miller's™	140	Swim Coach, Craven's™	160	Transparants	87	Wild Turkey Baetis, Kingrey's™	101
Spanish Perdigon, Rodrigues™	122, 134	Swim Coach Baby, Craven's™	160	Trico Dun, A.K.'s™	83	Winter's Hope 451, Howard's™	165
Sparkle Dun, Mathews™	71, 79, 150	Swimming Leech, Thurman's™	159	Trico Female Poly Spinner	81	Wired Stonefly, Befus™	126
Sparkle Dun Improved, Mathews™	71, 79, 101	Swing Caddis (Tungsten), Mercer's™	121	Trico Male Poly Spinner	81	Woolly Bugger	155
Sparkle Flag, Quigley's™	82	Swing Nymph (Tungsten), Mercer's™	121	Trigger Nymph, Mercer's™	124, 150	Woolly Bugger Brass Bead	155
Sparky's Floating Spider, Russell Anderson's™	57, 93	Swiss Army Slider, Janik's™	179	Triple Threat (Flats), Rea's™	179	Woolly Bugger Jig	155
Sparring Partner, Winkler's™	160	Tails Up Trico, Mayer's™	81	Triple Threat (Tarpon), Rea's™	189	Wulff	83
Spawning Mantis, Veverka's™	178	Tail Dragger Tube, Howard's™	165	Tube Skater	165	X Caddis, Mathews™	83
Spent Partridge Caddis, Lawson's™	82	Tailwater Jig Sowbug, Egan's™	135, 143	Tungsten Carotene Jig, Sexton's™	124, 135	X2 Caddis, Mathews™	83
Spinner	80	Tailwater Sowbug, Egan's™	143	Tungsten Drowned Ant, Cotter's™	87, 124	Y2K, Knowles™	138
Splatte Roller Tungsten Bead, Gunkel's™	123	Tailwater Sowbug CDC, Egan's™	143	Tungsten Junior Mint, Blumenshine's™	150, 155	Yank's Assassin, Yankanich's™	179, 185, 197
Split Flag, Quigley's™	82, 100	Tailwater Sowbug CDC Jig, Egan's™	134, 143	Tungsten Mercury Caddis, Dorsey's™	124	Yellow Sally, Silvey's™	83
Sponge Spider	57, 93	Tailwater Tiny	124	Tungsten Pheasant Tail Prince, Mercer's™	119	Z-Wing Caddis, Mercer's™	126
Spruce Almighty, C. Johnson's™	82	Tak's Crystal Chironomid, Takahashi's™	101, 150	Tungsten Surveyor, Egan's™	125, 135	Z-Wing Caddis (Bead Head), Mercer's™	126
Squimp	178	Tak's Egg Laying Caddis, Takahashi's™	83	Tungsten Thin Mint	151, 155	Z-Wing Caddis (Tungsten), Mercer's™	126
Squirmy Wormie	140	Tak's Mini Minnow, Takahashi's™	161	Tungstone Flashback, Barr's™	125	Zack Attack Damselfly, Thurman's™	151
Squirmy Wormie Jig	134, 140	Takahopper, Takahashi's™	91	Tuscan Bunny, Chicone's™	185, 197	Zebra Jig	126, 135
Stacked Sally, Quigley's™	82	Tarpon Toad (Rabbit Strip Tail), Merriman's™	188	Twisted Caddis, Smitherman's™	125	Zebra Midge (Tungsten)	101, 127
Starling Softie, Wade's™	105, 133	Tarpon Toad II (Marabou Tail), Merriman's™	189	Twisted Crane, Smitherman's™	125	Zebra Midge Thin	101, 127
Stay Hungry Streamer, Hansen's™	55	Tasmanian Devil	124, 135	Twisted Damsel, Smitherman's™	151	Zebra Two-Tone (Tungsten), Cady's™	101, 127, 151
Stealth Link, Mercer's™	82, 150	Techno Wog, Jansen's™	168	Twisted Stone, Smitherman's™	125	Zelon Midge Improved, Mathews™	101
Steelhead Bugger	166	Tequeely	155	Twisted Worm, Smitherman's™	135, 140	Zirdle Bug Jig	135, 161
Still Stone	82	Tequila Popper	57, 191	Two Bit Drake, Craven's™	125	Znail, Tokach's™	151
Stimulator (Barbless), Kaufmann's™	82	The Gunch, Sexton's™	83	Two Bit Hooker, Craven's™	126	Zonker	161
Stimulator Crystal, Kaufmann's™	82	The Roadrunner, Mill's™	164	Two Bit Hooker Jig, Craven's™	126, 135	Zug Bug Brass bead	177
Stimulator Crystal Rubberlegs, Kaufmann's™	82	The Studler, Mill's™	165	Two Bit Midge, Craven's™	101		
Stone Daddy, Ouelette's™	123	Thorax, Lawson's™	83	Two Bit Stone, Craven's™	126		
Strawberries & Cream, Ouelette's™	123, 134	Thread Frenchie Jig, Egan's™	124, 135	Two Wing Trico Spinner	81		
Strong Arm Merkin, Skok's™	178			Twofer, Hieronymus™	166		
Stubby Ant, Freed's™	87			Ultra Shrimp	179, 197		
Stubby Chubby	83, 93			Umpqua™ Cuda Fly	197		

NOTES

NOTES

